

中小学英语实验教材(沿海版)小学英语课本 第六册

新交际英语

English in Action

Book 6

沿海版中小学教材编写委员会 编

主编：桂诗春



外语教学与研究出版社

FOREIGN LANGUAGE TEACHING AND RESEARCH PRESS

新交际英语

中小学英语实验教材(沿海版)小学英语课本 第六册

English in Action

Book 6

沿海版中小学教材编写委员会 编

主编：桂诗春

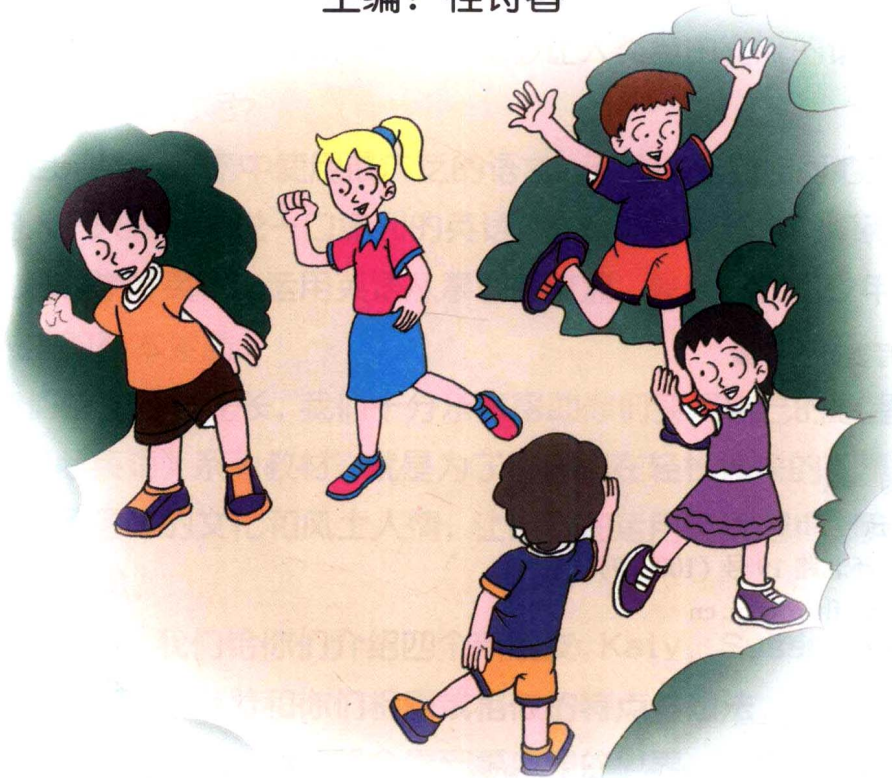

外语教学与研究出版社

FOREIGN LANGUAGE TEACHING AND RESEARCH PRESS

(京)新登字 155 号

新交际英语 6

沿海版中小学教材编写委员会 编

桂诗春 主编

* * *

责任编辑: 吴 静 杨 帆

出版发行: 外语教学与研究出版社

社 址: 北京市西三环北路 19 号 (100089)

网 址: <http://www.fltrp.com.cn>

印 刷: 北京大学印刷厂

开 本: 889×1194 1/16

印 张: 9.25

版 次: 2002 年 2 月第 1 版 2002 年 2 月第 1 次印刷

书 号: ISBN 7-5600-2572-2/G·1225

定 价: 13.00 元

* * *

如有印刷、装订质量问题出版社负责调换

制售盗版必究 举报查实奖励

版权保护办公室举报电话: (010)68917519

347

致读者

亲爱的小朋友们：

你们可曾想过周游世界，在异国的土地上与各国的小朋友随意畅谈？你们可曾想过打开电脑，在因特网的王国里自由翱翔？你们可曾想过当自己长大成人之后，能够在广阔的世界舞台上发挥自己的聪明才智，和不同肤色、不同语言、不同种族、不同信仰的人走到一起，探讨如何把我们的地球村建设得更加美好，让我们的未来更充满希望？相信你们一定会有这样的想法，因为你们是新世纪的希望，代表了人类的未来。

要让全世界的人汇聚在一起，就离不开语言这条纽带，因为世界不同地区的人说着不同的话。有一个关于巴比伦塔的神话说，古时候，人类想建一座直入云天的高塔，作为直通天国的道路，上帝为了破坏人类的努力，让建塔的人说不同的语言。这样，由于相互之间无法交流，人们相互猜疑，相互埋怨，最后一轰而散，高塔也随之坍塌。瞧，如果没有一种能够让人类自由交流的语言，我们怎能共同建设美好的地球村呢？

英语是目前国际交流中使用最广泛的语言。无论你走到任何地方，都能找到会说英语的人；只要你能说一口流利的英语，你就能跨越语言的障碍，在世界舞台上自由驰骋。学好英语，运用英语从事国际交流，是新一代青少年的希望，也是新一代人才的基本素质。

作为你们的前辈与兄长，我们十分乐意帮助你们实现自己的愿望。我们编写的这套《新交际英语》系列教材，就是为了让你们在轻松愉快的环境下，学习和使用英语，了解各国的文化和风土人情，让你们在运用英语进行交流的同时，享受无穷的学习乐趣。

在这套教材里，我们给你们介绍四个新朋友，Katy，Susan，Mike和Ben。他们是你们的同龄人，有着和你们相同或相似的特点与想法，并将伴随着你们一起长大。通过他们的眼睛，你们将会看到更广阔的世界，了解同龄人的生活，了解他们的想法与希望，与他们一起分享快乐的人生。同时，我们还给你们带来一个惊喜——Tammy and Dommy，这一对来自不同星球的兄弟，将会给你们带来无穷的乐趣。

不仅仅如此,在使用这本书的时候,你们还会发现英语学习其实并不枯燥乏味,相反,它会是生动有趣的。当你们唱着那些熟悉的曲调,朗诵那些流畅的诗歌时,你们将会发现语言韵律的美妙;当你们看着那些美丽的插图,玩着喜爱的游戏时,会发现自己不知不觉地使用英语和伙伴们交流。你们会觉得英语和汉语一样,并没有什么神秘,它只不过是人类表达思想和情感的一种工具,而且是一种十分有用的工具。它能够扩展你的视野,让你接触各种各样的文化和思想,让你在知识的海洋里能更自由地遨游。

亲爱的小朋友们,在你们打开这本课本,去探讨这个丰富的语言世界之前,请你们先认识你们的新朋友和伙伴,我们衷心祝愿你们能与他们共同成长,共创美好的未来。

编者

Katy



Susan

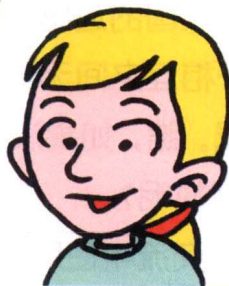

Mike



Ben

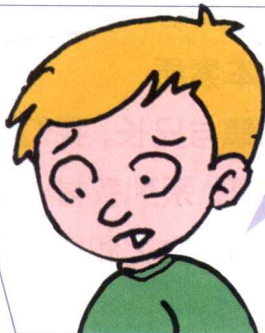

Tammy

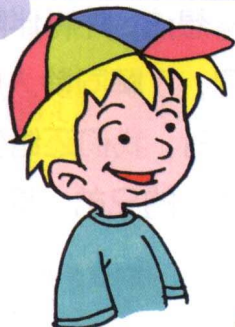

Dommy

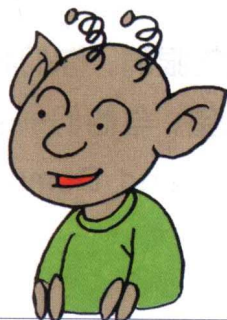

编者的话

《新交际英语》系列教材(English in Action)是一套按照最新颁布的《国家英语课程标准》(实验稿)编写的教材,全书20册,以小学三年级为起点,覆盖了课程标准的九级水平要求。目前完成编写出版的是1—6册(小学3—5年级)的实验教材。

这套教材是在原“九年义务教育教材(沿海版)”的基础上发展起来的,编者在保留原教材的特点的基础上,应用国际上先进的教育教学思想,针对我国学生的实际重新进行了设计。教材以促进学生素质发展为宗旨,向学生提供有益、健康、情趣高尚的语言材料,保障学生通过课程的学习能够获得必要的语言知识技能,发展语言能力和思维能力,同时得到情感、态度和价值观的熏陶。教材以学生为中心、以任务为驱动的方式展开教学内容,安排了大量新颖、多样的学习活动,创造有利学生学习的情境,激发学生的学习兴趣,引导学生的思维,让学生通过丰富多彩的学习活动,理解和掌握有关的知识技能,同时逐步掌握语言学习的规律。教材注意紧密联系学生的实际,包括生活的实际和学生的年龄和心理发展的实际。小学部分的教材针对学生的特点设计了大量听、说、唱、做、玩、演活动,让学生在轻松愉快的气氛中学习。教材还注意对西方文化的学习和介绍,让学生在逐步形成热爱祖国的高尚情操的同时,也学会了解和尊重别国的文化。

这套教材以我国语言学与应用语言学权威、教育部考试中心全国高考英语科命题委员会负责人、原广州外语学院院长桂诗春教授为主编,参加编写的还有鲁宗干、邹启明、唐锡玲、张杰、古瑛若、黄志红、黄秀萍、李季、何国平等。

本书得到香港大学课程系主任、知名英语教育专家Amy B. M. Tsui教授,北京外国语大学英语专家Lewis Sandler先生的支持,他们在百忙中抽出大量时间,审读了教材的初稿并提出了宝贵的修改意见,使教材得以改进。在此特向他们表示感谢。

除了教科书之外,《新交际英语》系列教材还包括配套的教师用书以及录音带、投影片等音像材料。

《新交际英语》系列教材由“沿海版中小学教材编写委员会”组织编写,外语教学与研究出版社出版发行。

沿海版中小学教材编写委员会

Contents

Unit One A Brithday Party 2

Lesson One 2

Lesson Two 9

Unit Two My Life 14

Lesson Three 14

Lesson Four 20

Unit Three My Country 26

Lesson Five 26

Lesson Six 32

Unit Four Travel 38

Lesson Seven 38

Lesson Eight 43

Unit One

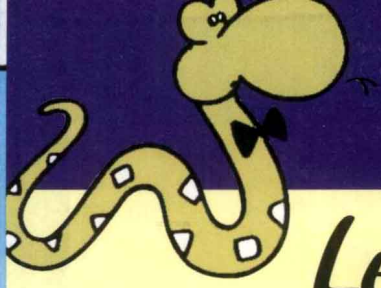

Lesson One

A Rhyme

That little pig goes to the beach,

This little pig stays at home.

That little pig has roast beef,

This little pig only has Coke.

That little pig cries, "Wee, wee, wee!"

Hurrying all the way home.

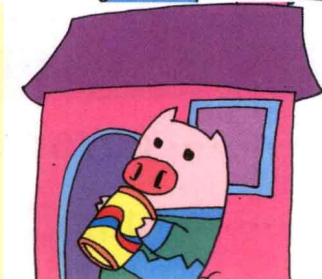

A Birthday Party

Lesson One

A Talk

Waiter: May I take your order, Madam?

Mum: Yes, I'd like two hamburgers, please.

Waiter: Anything to drink?

Ben: Yes, a Coke, please.

Mum: And a cup of tea, too.

Waiter: Is that all?

Mum: Yes.

Mum: Let's see what we've got for your birthday party.

Ben: Headbands, paper plates, paper cups, some drinks and some candles, too.

Mum: That's all, isn't it?

Ben: But we miss one thing, Mum.

Mum: Oh, you are right. We forgot the birthday cake!



Unit One

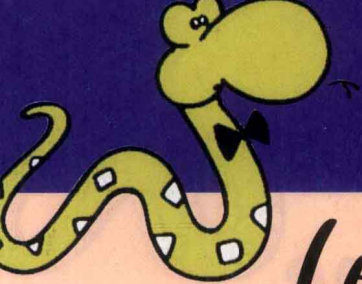

Lesson One



Task 1 Today is your birthday. Choose your food and drink, and then tell your partner.



birthday cake

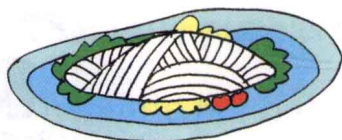

noodles



fried rice



pizza

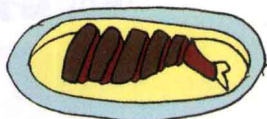

steak

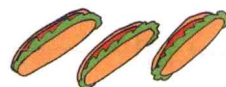

hot dog



salad



vegetable



milk



orange juice

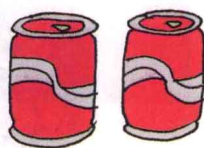

Coke



mineral water



A Birthday Party

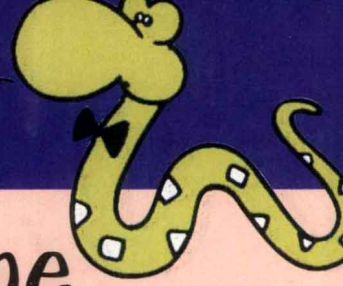

Lesson One

Task 2 A Tongue Twister

I wish you wish they wish,
We all wish the same wish:
To have many sandwiches,
And better if they have fish!

My hands are clean,
Your hands are clean.
His hands are clean,
Her hands are clean.
Our hands are all clean,
Please give us the ice-cream!

Let's Act

Task 1 Write a birthday card to your partner.

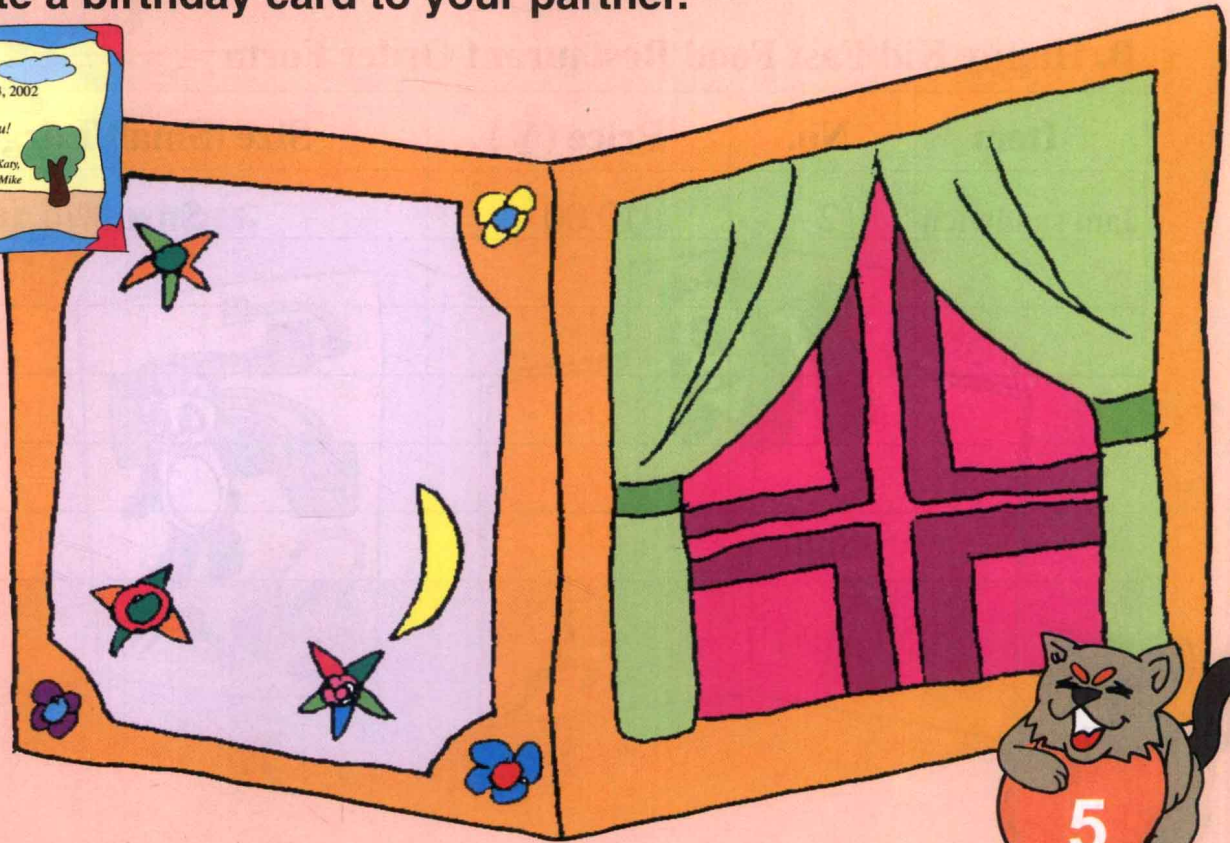
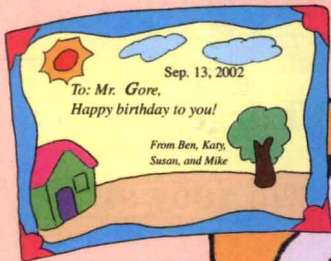

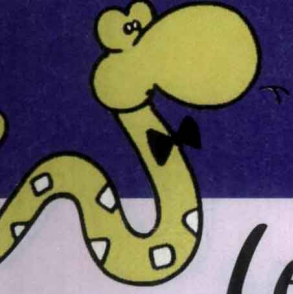

Unit One

Lesson One

Task 2 Give a menu to your partner and take his/her order.

A. Happy Kid Fast Food Restaurant Menu

Main Course		Drinks		Sandwiches	
Chicken Rice	¥ 6.00	Orange Juice	¥ 3.50	Hamburger	¥ 7.50
Fried Rice	¥ 4.50	Coke	¥ 5.00	Hamburger and Egg	¥ 8.50
Pizza	¥ 25.00	Hot Tea	¥ 2.50	Hamburger and Fish	¥ 6.50
Jam sandwich	¥ 5.00	Hot Milk	¥ 4.00	Hot Dog	¥ 3.50

B. Happy Kid Fast Food Restaurant Order Form

Item	No.	Price (¥)	Size (Small/Large)
Jam sandwich	2	10.00	Small
Sum:			



A Birthday Party

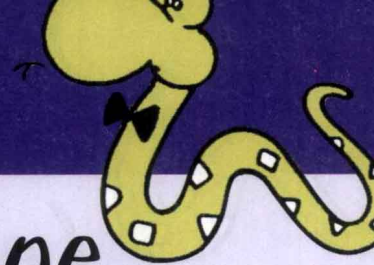

Lesson One



Make a birthday card for your best friend.

1. Get things ready.

2. Fold and cut the paper.

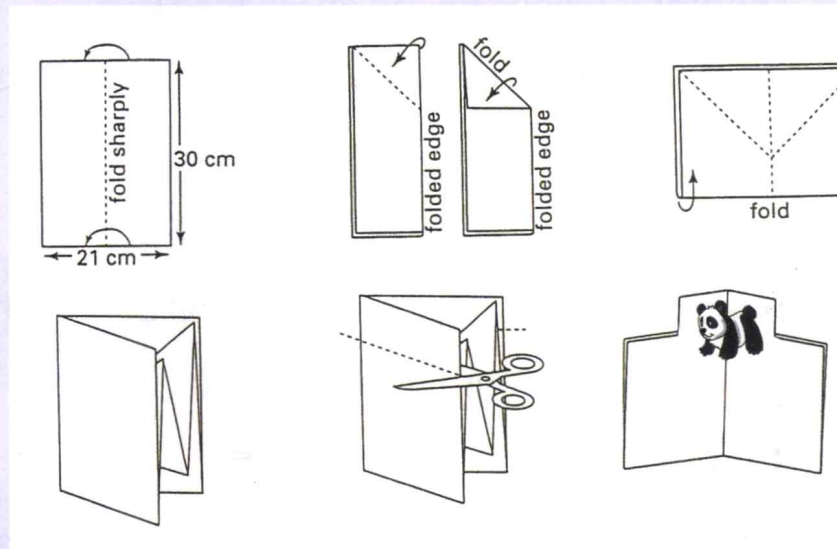
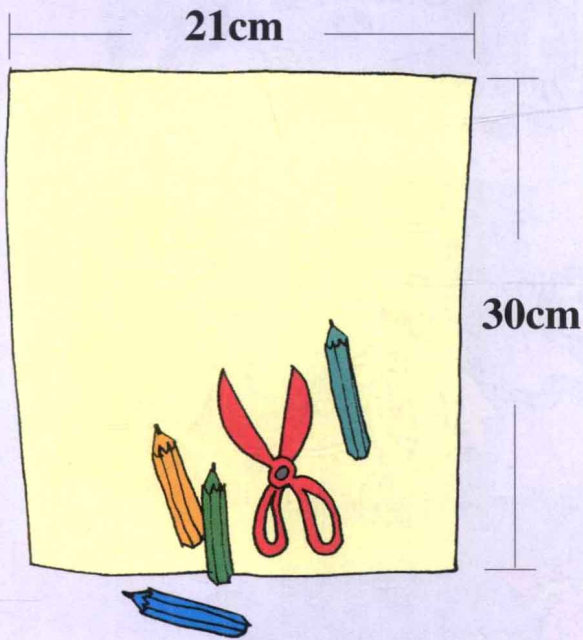

3. Write your best wishes.

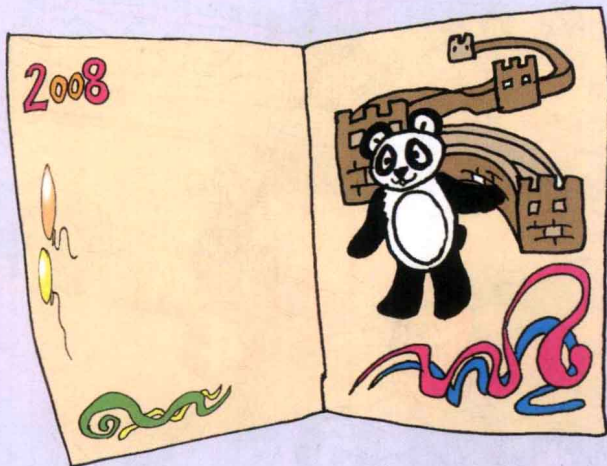

Unit One

Lesson One

Tammy and Dommy

Tammy: Dommy, today is my birthday.

Dommy: Good! Be my guest.

Dommy: What would you like?

Tammy: Well...

Dommy: How about a birthday cake?

It's your birthday today.

Tammy: Great!

Dommy: Happy birthday to you!

Tammy: Thank you.

Boy: Help! Help!

Tammy: Coming!

Dommy: What a wonderful birthday present!



A Birthday Party

Lesson Two

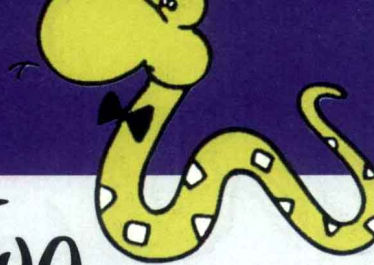

A Song

Happy Birthday

1=C 2/4

5 . 5 | 6 5 | i 7 |
Hap- py birth-day to you!

5 . 5 | 6 5 | 2̇ i |
Hap- py birth-day to you!

5 . 5 | 5̇ 3 | 1 7̇ | 6— |
Hap- py birth-day to Ben- ny,

4 . 4 | 3 1 | 2 1 ||
Hap- py birth-day to you!





Lesson Two

A Talk

Katy:

Mike: Happy birthday to you, Ben.

Susan:

Ben: Thank you.

Mike: Here's my present.

Ben: What a nice car! Thank you.

Katy: Many happy returns!

Ben: How wonderful, thanks.

Susan: Look at my present! Does it look like you?

Ben: Well... well...

Mike: I'm very hungry.

Ben: I've got some cookies.

Susan: One, two, three... but there are only nine!

Mike: I'll take two.

Katy: I'll take two.

Ben: I'll take two.

Susan: I'll take one!

Susan: Now, I'll take two.

Mike:

Katy: Oh...

Ben:

