

PennyPress

Word Games

433 PUZZLES FOR PUZZLE LOVERS

**433
PUZZLES
MORE
FOR YOUR
MONEY!**

48

- **A DELIGHTFUL VARIETY OF PUZZLES**
- **SELECTED FOR YOU BY THE EDITORS**

PennyPress®

Word Games

FOR PUZZLE LOVERS

48

Penny Press is the publisher of a fine family of puzzle magazines and books which are renowned for their editorial excellence.

This delightful collection has been carefully selected for your special enjoyment and entertainment by the editors of Penny Press.

PENNY PRESS, INC.
6 Prowitt Street, Norwalk, Connecticut 06855

LONGMEADOW
P R I N T S

PennyPress

Word Games

433 PUZZLES FOR PUZZLE LOVERS

**433
PUZZLES
MORE
FOR YOUR
MONEY!**

48

- A DELIGHTFUL VARIETY OF PUZZLES
- SELECTED FOR YOU BY THE EDITORS

PennyPress

Word Games

FOR PUZZLE LOVERS

**433
PUZZLES
MORE
FOR YOUR
MONEY!**

48

LONGMEADOW



ISBN 0-681-45270-6

PennyPress®

Word Games

FOR PUZZLE LOVERS

48

Penny Press is the publisher of a fine family of puzzle magazines and books which are renowned for their editorial excellence.

This delightful collection has been carefully selected for your special enjoyment and entertainment by the editors of Penny Press.

PENNY PRESS, INC.
6 Prowitt Street, Norwalk, Connecticut 06855

LONGMEADOW
P R I N T S

PENNY PRESS PUZZLE PUBLICATIONS

**All-Star Word Seek Puzzles
Approved Crossword Puzzles
Approved Crosswords Jumbo Issue
Classic Crosswords Jumbo Issue
Easy & Fun Word Seek Puzzles
England's Finest Logic Problems
Family Crossword Puzzles
Family Variety Puzzles and Games
Family Word Seek Puzzles
Favorite Variety Puzzles and Games
Favorite Word Seek Puzzles
Fill-In Puzzles
Good Time Crossword Puzzles
Good Time Fill-In Puzzles
Good Time Variety Puzzles
Good Time Word Seek Puzzles
Merit Variety Puzzles and Games
Nice & Easy Crosswords
Original Logic Problems
Super Word Seek Puzzles
Variety Puzzles and Games
Variety Puzzles and Games Jumbo Issue
Word Seek Puzzles**

**Crossword Puzzles for Puzzle Lovers
Fill-In Puzzles for Puzzle Lovers
Word Games for Puzzle Lovers
Word Seek for Puzzle Lovers
Anniversary Edition, Puzzles for Puzzle Lovers
Summer Fun Edition, Puzzles for Puzzle Lovers**

**Selected Anagram Magic Squares
Selected Brick by Brick
Selected Codewords
Selected Crostics
Selected Crypto-Families
Selected Cryptograms
Selected Diagramless
Selected Double Trouble
Selected Logic Problems
Selected Missing Vowels
Selected Quotefalls
Selected Syllacrostics**

JIGSAW SQUARES

Your goal is to fit the PUZZLE PIECES into their proper places in the diagram to reveal a quotation. Fill the diagram by placing the PUZZLE PIECES horizontally into their corresponding sections of the diagram. There are 16 sections, identified by letter-number combinations (A-1, A-2, A-3, etc.). The quotation reads left to right, line by line. A black square indicates the end of a word. One PUZZLE PIECE has been entered for you.

Solution on page 322

PUZZLE PIECES

A-1 I F N IN LA TY IRIT	A-2 E MA OUR UAL INET	A-3 EEN THE LEAD XILE	A-4 D O ER SP DALA EIGH	B-1 F S ED TI TICI TOUR	B-2 OF BET PATI TATE	B-3 I S BY NG THE BEGA	B-4 A A N N PAR UNIT
C-1 Y CO IUM MONT RELI	C-2 M AT HE GIOU LLEG	C-3 E S IN SY WAS IDDL	C-4 VER EBUR GREE MPOS	D-1 G T STU TED READ	D-2 C ON HEL DENT SHIR	D-3 D S T LO TS WE AMPU	D-4 S BY HAT ALAI ARIN

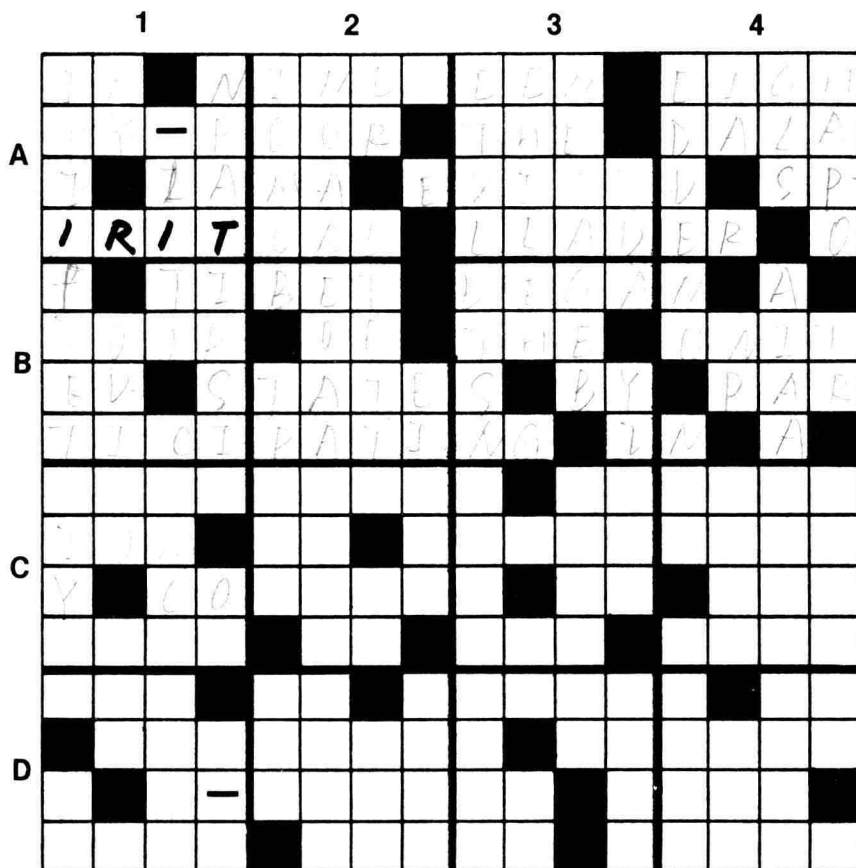

BULL'S EYE SPIRAL

This is a new target for those who can think in circles. The game works two ways, outward and inward. If you are outward bound, guess the word that fits clues 1-3 (the numbers correspond to the number of letters in the answer). Then go on to clue 4-8 and so on. If you're stuck with an outward-bound word, try the inward clues. Work both ways to hit the Bull's Eye. Solution on page 322

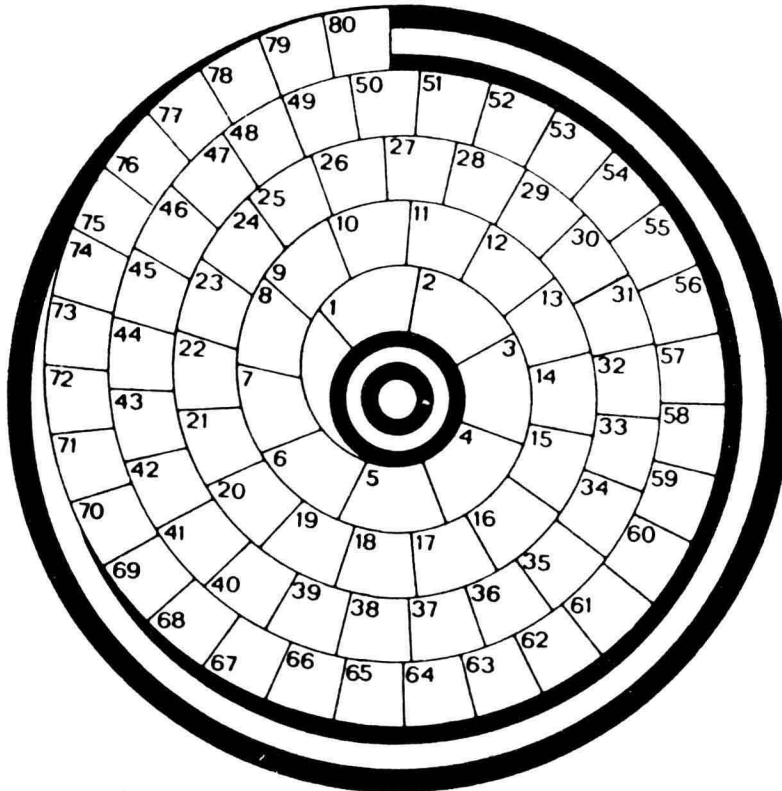

OUTWARD

- 1-3. Butterfly catcher
- 4-8. "___ Marner"
- 9-13. Monarch
- 14-18. Hebrew leader
- 19-23. Ran at top speed
- 24-29. Patterned sock
- 30-34. Claw
- 35-41. Fast, in music
- 42-48. Cartilage
- 49-56. West Indies island
- 57-62. California peak
- 63-66. Baal
- 67-72. Mideast country
- 73-77. Hag
- 78-80. Credibility ___

INWARD

- 80-77. Congressional attendant
- 76-74. And not
- 73-69. Distinct
- 68-65. Farm structure
- 64-60. Eats by candlelight
- 59-53. Sodium carbonate: 2 wds.
- 52-50. Bikini part
- 49-46. Karate award
- 45-43. Knight's title
- 42-38. Deep, narrow pass
- 37-33. Grassy plain
- 32-27. Not long ago
- 26-22. Mark
- 21-17. South American Indian
- 16-11. Oil measure
- 10-7. ___ Major
- 6-1. Lend an ear

BIG QUESTION

Start at the arrow and put the answers to the clues into the diagram in the order in which they are given. Every answer word overlaps the previous answer words by 1 letter or more. The first letters of all the answer words are shown in the diagram. When the Big Question is filled, place the 8 numbered letters into their corresponding spaces in the square at the bottom to reveal the answer to the riddle.

Solution on page 322

RIDDLE: *What was the inebriated poker player unable to see?*

CLUES

1. Dinner beverage
2. Drink of the gods
3. Scent
4. Kind of clam chowder
5. Sweet liqueur
6. Afternoon beverage
7. Pungent liquid
8. Most mature
9. Sharp taste
10. Take in orally
11. Trance
12. Request menu items
13. Boner
14. Citrus fruit
15. Of heavenly innocence
16. North Pole cover
17. Cider fruit
18. Citrus fruit
19. Salad ingredient
20. Upon
21. Bloody Mary juice
22. Gin and ____
23. Bygone delivery person
24. Coped
25. Fit to eat

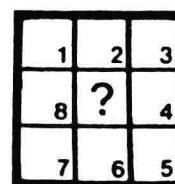
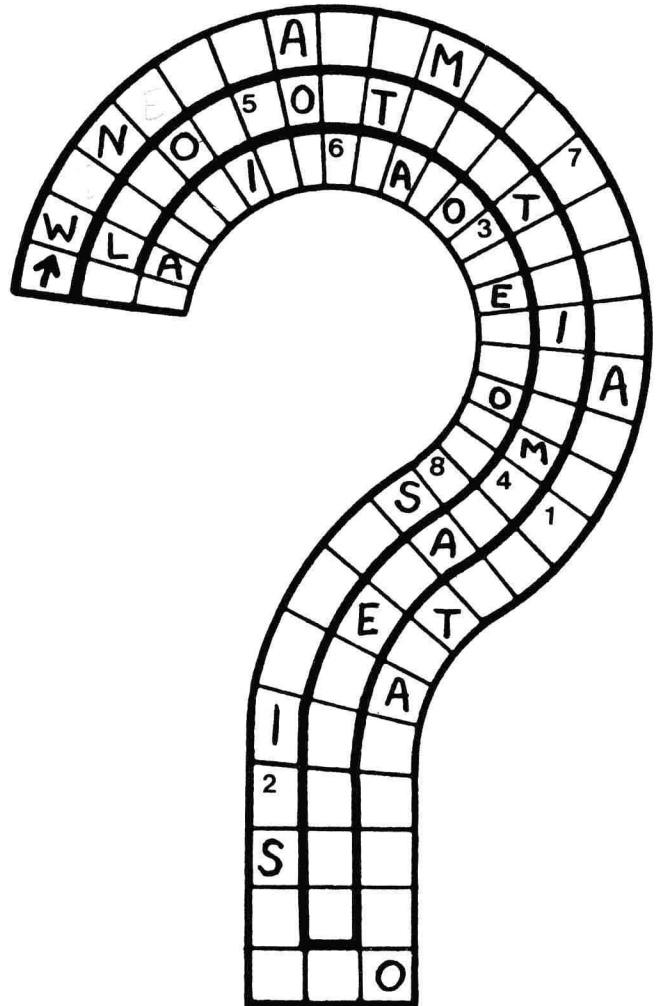



PUZZLE DERBY



Ladies and gentlemen, the horses are at the starting gate. Select your favorite (A, E, I, O, or U), and the race is on. First fill in the blanks with the answers to the clues. Vowels always go above numbered dashes, and consonants above unnumbered ones. All answers have something in common. Then, to find out who wins the race, move the horses around the track according to the number values under the vowels. The winners and the word list are given on page 322.

Example: $\frac{A}{2} \frac{L}{4} \frac{O}{1} \frac{U}{1} D$, move 2 spaces ahead in Lane A, 4 in Lane O, and 1 in Lane U.

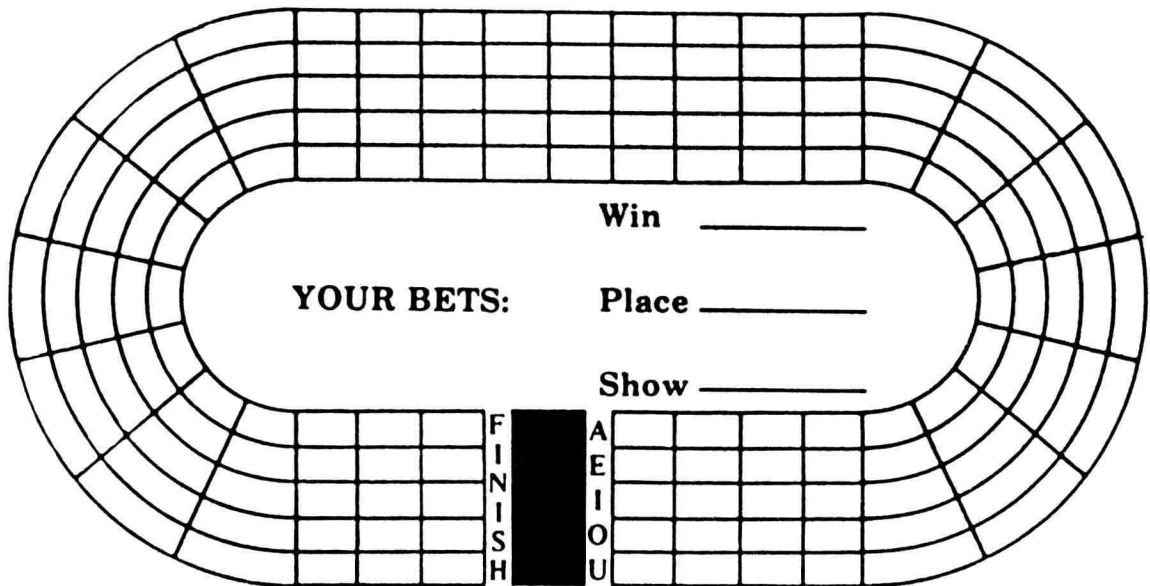

- | | |
|------------------------|---|
| 1. Script | $\frac{D}{6} \frac{W}{6} \frac{N}{3}$ |
| 2. Gridiron sport | $\frac{B}{4}$ |
| 3. Stale joke | $\frac{C}{2} \frac{S}{4}$ |
| 4. Newspaper banner | $\frac{H}{3} \frac{L}{5} \frac{2}{2}$ |
| 5. Truce | $\frac{M}{2} \frac{T}{5} \frac{3}{6}$ |
| 6. Space to move about | $\frac{B}{2} \frac{R}{5} \frac{4}{6}$ |
| 7. Four-in-hand | $\frac{K}{2} \frac{3}{2}$ |
| 8. Genuflecting | $\frac{N}{3} \frac{G}{3} \frac{2}{2}$ |
| 9. '60s nonconformist | $\frac{P}{2} \frac{2}{2}$ |
| 10. Lawful | $\frac{G}{2} \frac{M}{6} \frac{T}{2} \frac{2}{2}$ |

PICTURE THIS

You do not need any special art training to produce a picture in the empty grid. Use the letter-number guide above each square and carefully draw what is shown into the corresponding square in the grid. **Solution on page 322**

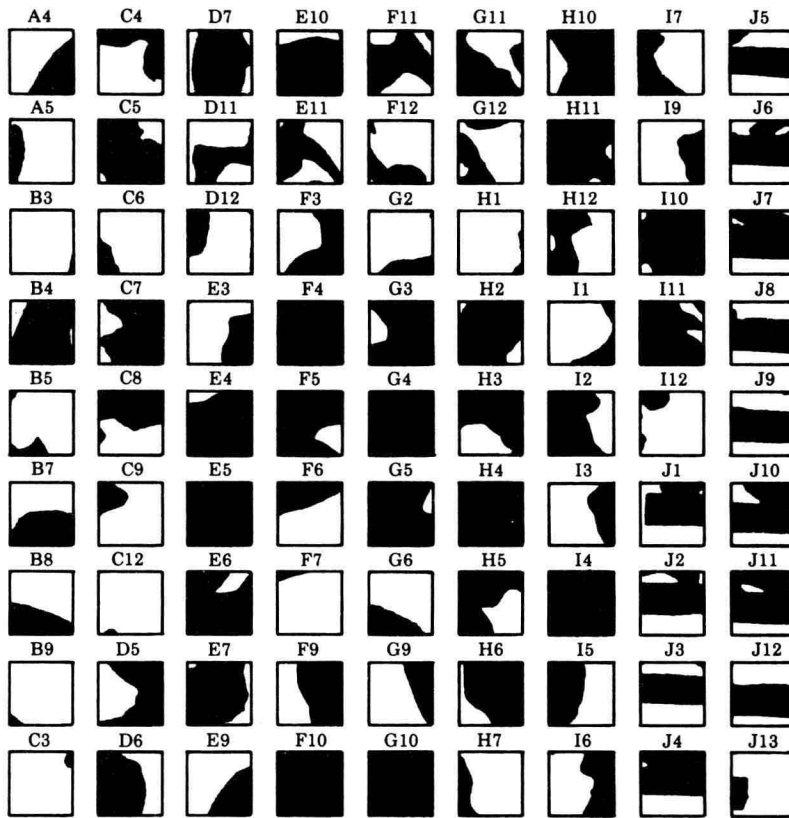

1 2 3 4 5 6 7 8 9 10 11 12 13

A												
B												
C												
D												
E												
F												
G												
H												
I												
J												

THREE PLUS THREE

Place the 3-letter groups into the diagram to form words of 6 letters as indicated by the arrows.

Solution on page 322

AND
 ANT
 ARD
 BES
 CON
 DEM
 DER
 ENT
 FER ✓
 FLA ✓
 IDE
 ING
 INS
 LAR
 LER
 OTS
 PIL
 REE
 SEC
 STR
 SUL
 TAN
 TOW
 URE
 VOR ✓

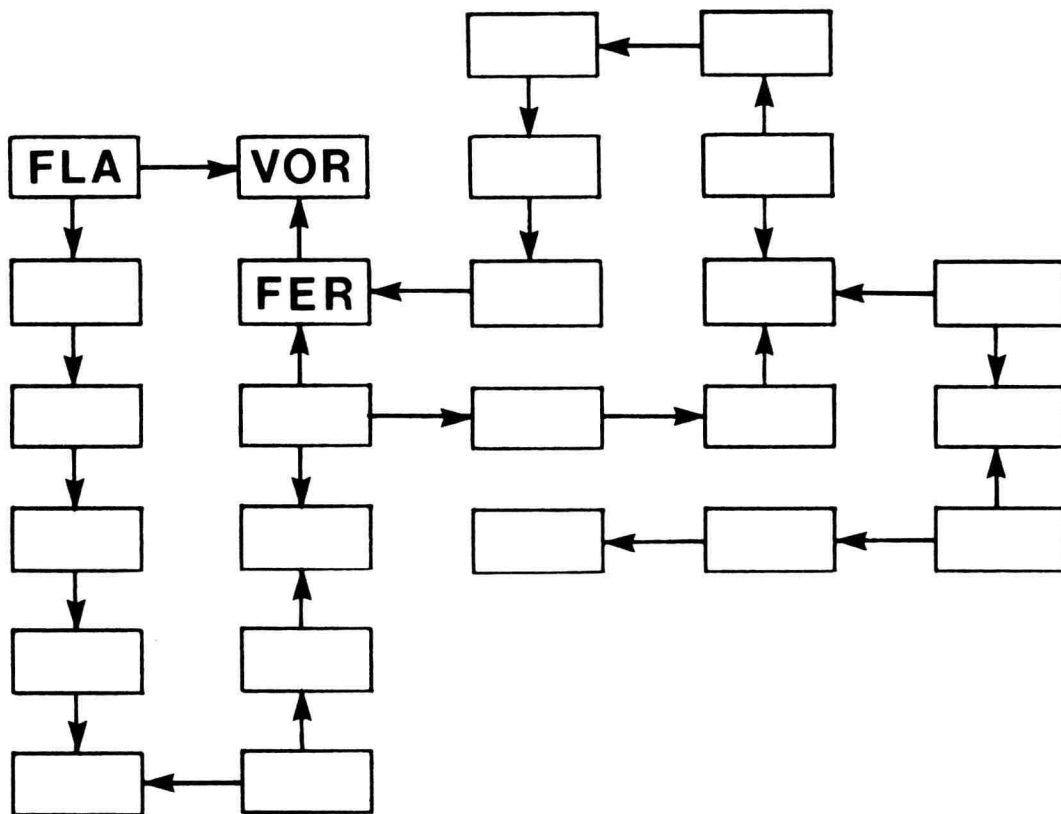

SUM WORDS

This puzzle adds words instead of numbers, which makes it somewhat different. Answer the top two clues in each problem with words containing the number of letters indicated in parentheses. Then rearrange these letters to find the Sum Words answer. If the math eludes you, try working backwards!

Solutions on page 322

- | | |
|--|---|
| <p>1. Casanova (5)</p> <p>+ Melody (4)</p> <hr style="width: 100%;"/> <p>= Service offerer (9)</p> | <p>2. Rye, for one (5)</p> <p>+ Type type (5)</p> <hr style="width: 100%;"/> <p>= On purpose (10)</p> |
| <p>3. Happenings (6)</p> <p>+ Coin factory (4)</p> <hr style="width: 100%;"/> <p>= Savings bond, e.g. (10)</p> | <p>4. Primp (5)</p> <p>+ Shopper's wagon (4)</p> <hr style="width: 100%;"/> <p>= Builder (9)</p> |

SWITCHBOARD

The answers to the clues are 7-letter words. Words share groups of letters as indicated by the diagram. For example, the first two words in the diagram share the same first three letters. The clues are given in no particular order. The answer to the first clue has been filled in for you. Solution on page 322

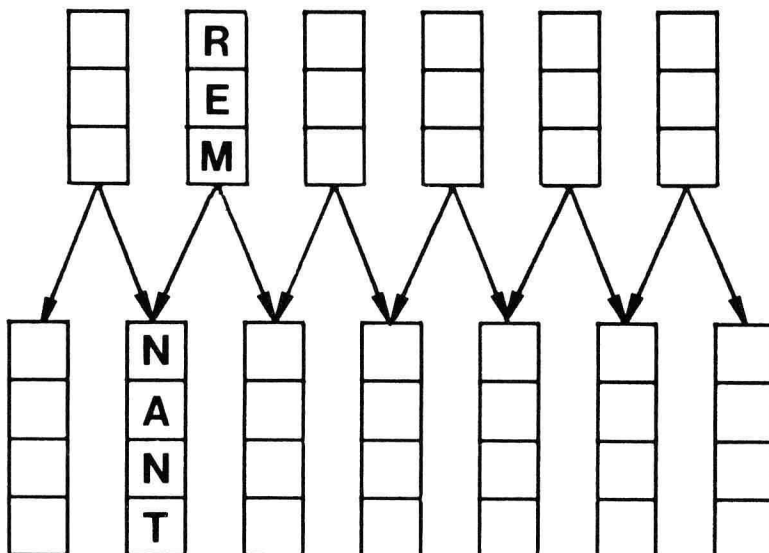

Leftover ✓

Sign over

Intention

Flag

Suggest

Litigation

Everlasting

Hanging ornament

You or him, e.g.

Chase

Ungoverned

Contribution

CATEGORIES

Can you think of a word or phrase for each of the categories listed beginning with each letter on the left? Count one point for each correct answer. A score of 15 is good, and 21 is excellent.

Our solution on page 322

WORDS CON-
TAINING "Q"

RHYMES
WITH "Q"

QUEENS
AND KINGS

GREEN
THINGS

COURTROOM
WORDS

S					
M					
I					
L					
E					

ROUNDERS

The names of nine elements are hidden in the Rounders diagrams below. For each one, start at one of the letters and read either clockwise or counterclockwise. Solutions on page 322

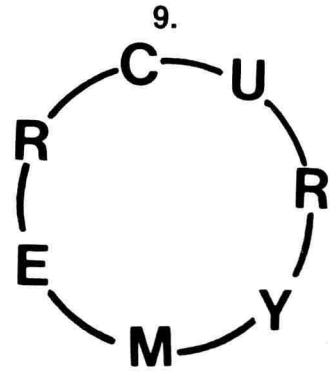
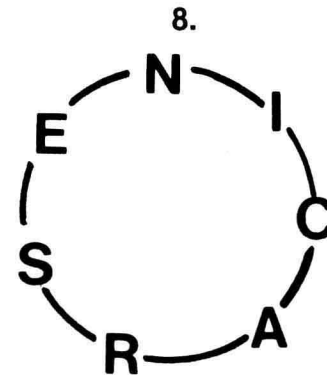
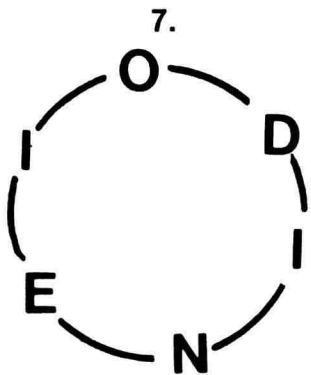
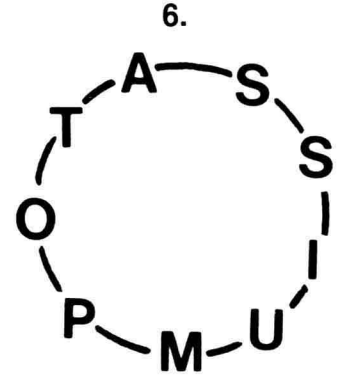
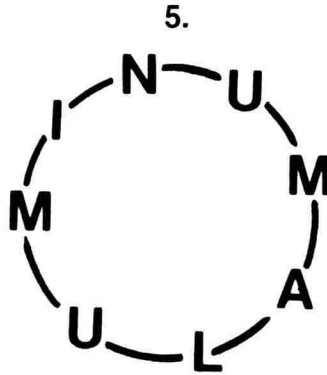
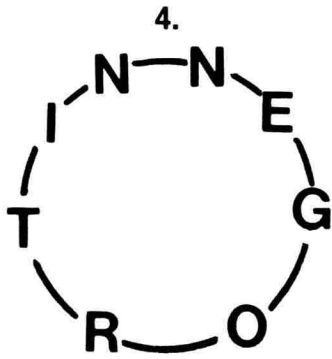
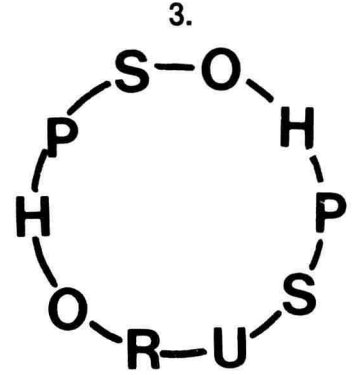
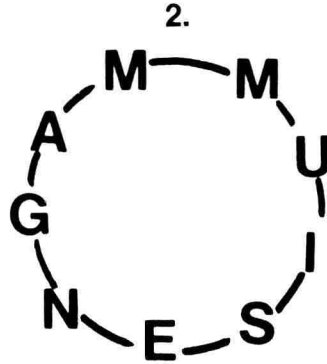
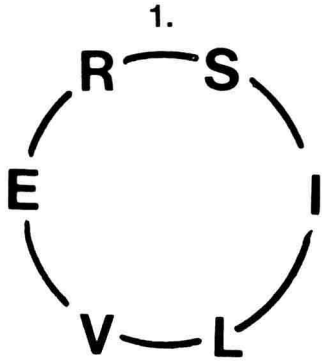

QUOTAGRAMS

Fill in the answers to the clues below. Then transfer the letters to the correspondingly numbered squares in each diagram. Each completed diagram will contain a quotation. **Solutions on page 322**

- A.**
- | | | | |
|---------------------------|--|--------------------------|--|
| 1. Like rich young people | <u>13</u> <u>29</u> <u>11</u> <u>14</u> <u>27</u> <u>34</u> | 5. Respectful ear | <u>12</u> <u>30</u> <u>49</u> <u>5</u> <u>48</u> <u>44</u> <u>46</u> <u>42</u> <u>32</u> |
| 2. Most humorous | <u>10</u> <u>25</u> <u>3</u> <u>20</u> <u>7</u> <u>16</u> <u>47</u> <u>33</u> | 6. Theater starting hour | <u>40</u> <u>45</u> <u>35</u> <u>24</u> <u>6</u> <u>18</u> <u>26</u> <u>9</u> |
| 3. Mexican dog | <u>17</u> <u>4</u> <u>39</u> <u>22</u> <u>36</u> <u>19</u> <u>38</u> <u>43</u> <u>31</u> | 7. Spacious | <u>15</u> <u>23</u> <u>28</u> <u>8</u> <u>2</u> |
| 4. Computer character | <u>1</u> <u>41</u> <u>37</u> <u>21</u> | | |

1	2		3	4	5		6	7	8	9		10	11		12	13	14	15	16
17	18	19	20	21		22	23	24		25	26	27	28	29	30	31	32	33	
34	35	36	37	38		39	40		41	42	43	44	45		46	47	48	49	

- B.**
- | | | | |
|-----------------------------------|--|-------------------------|---|
| 1. Tint | <u>19</u> <u>30</u> <u>11</u> | 5. Accumulate | <u>1</u> <u>47</u> <u>21</u> <u>27</u> <u>25</u> |
| 2. Mrs. Shakespeare's maiden name | <u>37</u> <u>14</u> <u>26</u> <u>40</u> <u>34</u> <u>7</u> <u>46</u> <u>17</u> | 6. Factually | <u>24</u> <u>2</u> <u>51</u> <u>6</u> <u>36</u> <u>32</u> |
| 3. Tolerable: hyph. | <u>10</u> <u>4</u> <u>16</u> <u>29</u> | 7. Far-reaching | <u>41</u> <u>45</u> <u>22</u> <u>44</u> <u>49</u> <u>39</u> <u>48</u> <u>35</u> <u>50</u> |
| 4. Kids | <u>18</u> <u>8</u> <u>38</u> <u>31</u> <u>43</u> <u>23</u> <u>12</u> <u>5</u> | 8. Nautical cry: 2 wds. | <u>13</u> <u>28</u> <u>20</u> <u>15</u> <u>42</u> <u>33</u> <u>9</u> <u>3</u> |

1	2	3	4	5	6		7	8	9		10	11	12	13		14		15	16
17	18	19	20	21	22	23	24	25	26		27	28	29	30	31	32		33	34
35	36		37	38	39		40	41	42	43		44	45	46	47	48	49	50	51

- C.**
- | | | | |
|---------------------------------|---|---------------------------|--|
| 1. Mother's cold remedy: 2 wds. | <u>48</u> <u>21</u> <u>15</u> <u>23</u> <u>43</u> <u>5</u> <u>39</u> <u>59</u> | 5. Pleasant remembrance | <u>38</u> <u>12</u> <u>10</u> <u>33</u> <u>58</u> <u>34</u> <u>53</u> <u>8</u> <u>20</u> |
| | <u>17</u> <u>4</u> <u>7</u> | 6. Proclamation beginning | <u>44</u> <u>45</u> <u>30</u> <u>52</u> <u>54</u> <u>46</u> <u>16</u> |
| 2. Summer drink | <u>26</u> <u>37</u> <u>36</u> <u>22</u> <u>18</u> <u>35</u> <u>40</u> <u>51</u> | 7. Universe: 3 wds. | <u>49</u> <u>50</u> <u>13</u> <u>29</u> <u>57</u> <u>14</u> <u>24</u> <u>25</u> |
| 3. On a cruise | <u>28</u> <u>6</u> <u>19</u> <u>55</u> | | <u>56</u> <u>27</u> <u>41</u> <u>9</u> <u>2</u> <u>32</u> |
| 4. Begins | <u>11</u> <u>47</u> <u>1</u> <u>3</u> <u>31</u> <u>42</u> | | |

1		2	3	4	5		6	7	8	9	10	11		12	13	14		15	
16		17	18	19		20	21	22		23	24	25		26	27	28	29	30	
	31	32	33		34	35	36	37		38	39	40		41	42	43		44	
45	46	47		48	49	50	51	52	53	54	55	56	57	58	59				

WHAT AM I?

My first is in Caesar, but never in Kaye.

My second's in Coca, but never in Raye.

My third is in Lemmon, but never in Benny.

My fourth is Hope and also in Henny.

My fifth is in Diller, but never in Sahl.

My sixth is in Crosby, but never in Ball.

I'm never serious—I try to be gay.

I'll hand you a laugh, 'cause I'm funny that way.

Solution on page 322

BITS AND PIECES

Can you identify the six famous actors and actresses from the Bits and Pieces shown in the boxes below?
The first name is always on top. Solutions on page 322

1.

B	E	R
D	F	O

2.

O	L	D
A	W	N

3.

M	E	S
A	A	N

4.

A	N	E
O	N	D

5.

O	B	E
I	R	O

6.

L	I	N
S	T	W

POETIC LICENSE

The answers to the clues below are 3-syllable terms and words that all rhyme with one another.

Solution on page 322

1. Welcome assistance _____
2. Smuggled goods _____
3. Small, elegant piano _____
4. Canadian island _____
5. Famous French statesman _____
6. German musicians who play in waltz tempo _____
7. Comprehend _____
8. Her fans had fans _____
9. Scold _____
10. Revoke _____

COMBOS

Form twelve long words by joining pairs of short words and placing the letter H at the beginning. For example, the pair of words EAT and HER, with the letter H at the beginning, form HEATHER.

Solution on page 322

A	DRY	ERE	OVER	_____	_____
AMP	ED	IN	RED	_____	_____
AND	EIGHT	OLD	SOME	_____	_____
AT	EN	ON	STY	_____	_____
AUNT	ER	ONE	US	_____	_____
BAND	ERAL	OR	YEN	_____	_____

GUESSTIMATES

Here's an opportunity to practice your "guesstimating" skills. Allowing 5 seconds for each one, look carefully at each rectangle below and try to guess how many letters or numbers are contained in it.

Solution on page 322

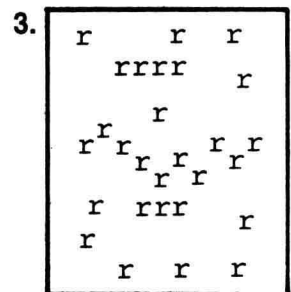
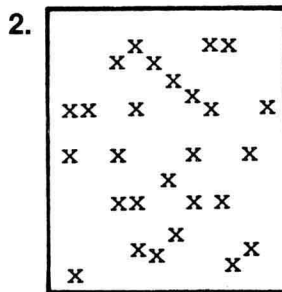
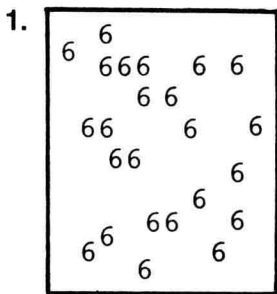

IN SO MANY WORDS

The answers to the two clues for each number below are words that sound alike but are spelled differently. Can you identify each pair of sound-alikes?

Solutions on page 322

Example: Used a paddle = rowed
Thoroughfare = road

- | | | | |
|---------------------|-------|---------------------|-------|
| 1. Prune's origin | _____ | 5. Pit | _____ |
| Lead-weighted line | _____ | Complete | _____ |
| 2. Forgo, as rights | _____ | 6. Square or granny | _____ |
| Greet with the hand | _____ | Negative word | _____ |
| 3. Ocean movement | _____ | 7. Medieval figure | _____ |
| Bound | _____ | Ride the waves | _____ |
| 4. Play division | _____ | 8. Male hog | _____ |
| Witnessed | _____ | Uninteresting one | _____ |