

浙江人民美术出版社

文字·数字·智力的综合基础学习

多湖辉编
NEW
头脑开发丛书

暑期训练

培养学习习惯的集中训练

4

岁



奖励贴纸

随书附赠
可擦拭的
游戏卡片



月	日	姓名
---	---	----



剪下下面的海豚图片贴一贴吧！
海豚的数量一共是多少呢？



描一描吧！

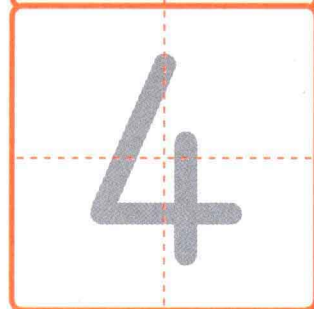
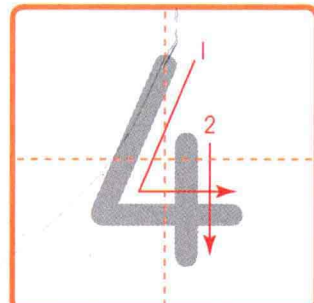

试着写一写吧！

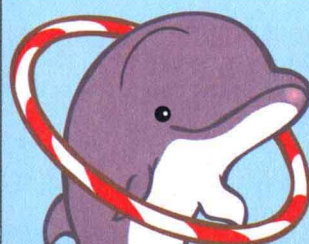
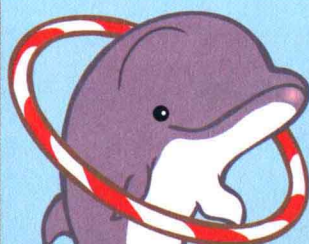
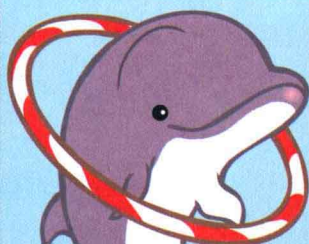
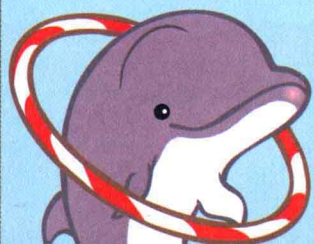
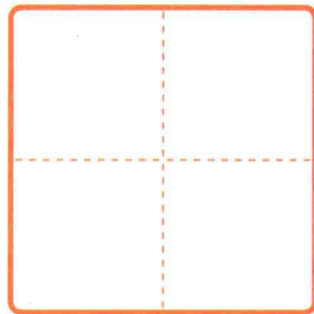

月	日	姓名
---	---	----



读一读、背一背古诗吧！

咏 鹅

[唐] 骆宾王

鹅，鹅，鹅，
 曲项向天歌。
 白毛浮绿水，
 红掌拨清波。



胶
水

胶
水

胶
水

胶
水



		姓名
月	日	



剪下下面的图片贴一贴吧！
乌龟的数量一共是多少呢？

乌龟

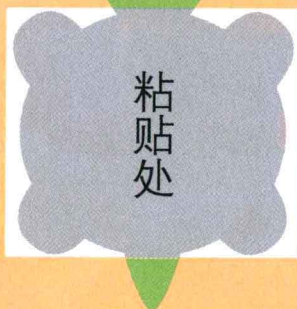

描一描吧！

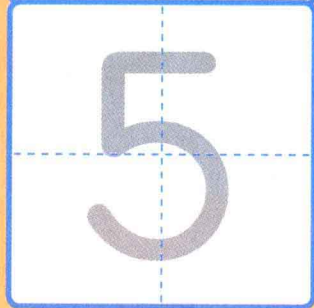
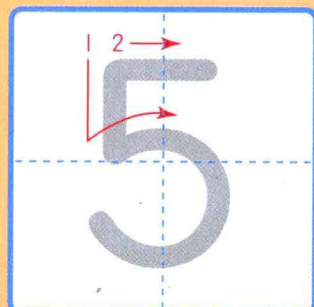

试着写一写吧！

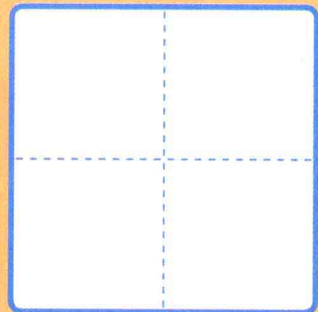

月	日	姓名
---	---	----



粘贴与图吻合的文字贴纸吧！
描一描 — — — 吧！



胶水

胶水

胶水

胶水

胶水



		姓名
月	日	



剪下下面的牵牛花图片贴在恰当的地方吧！
牵牛花一共是多少朵呢？

描一描吧！

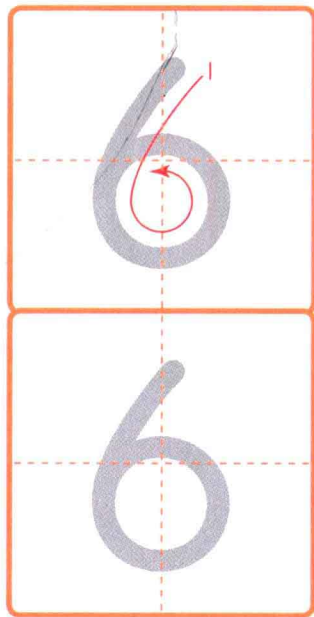
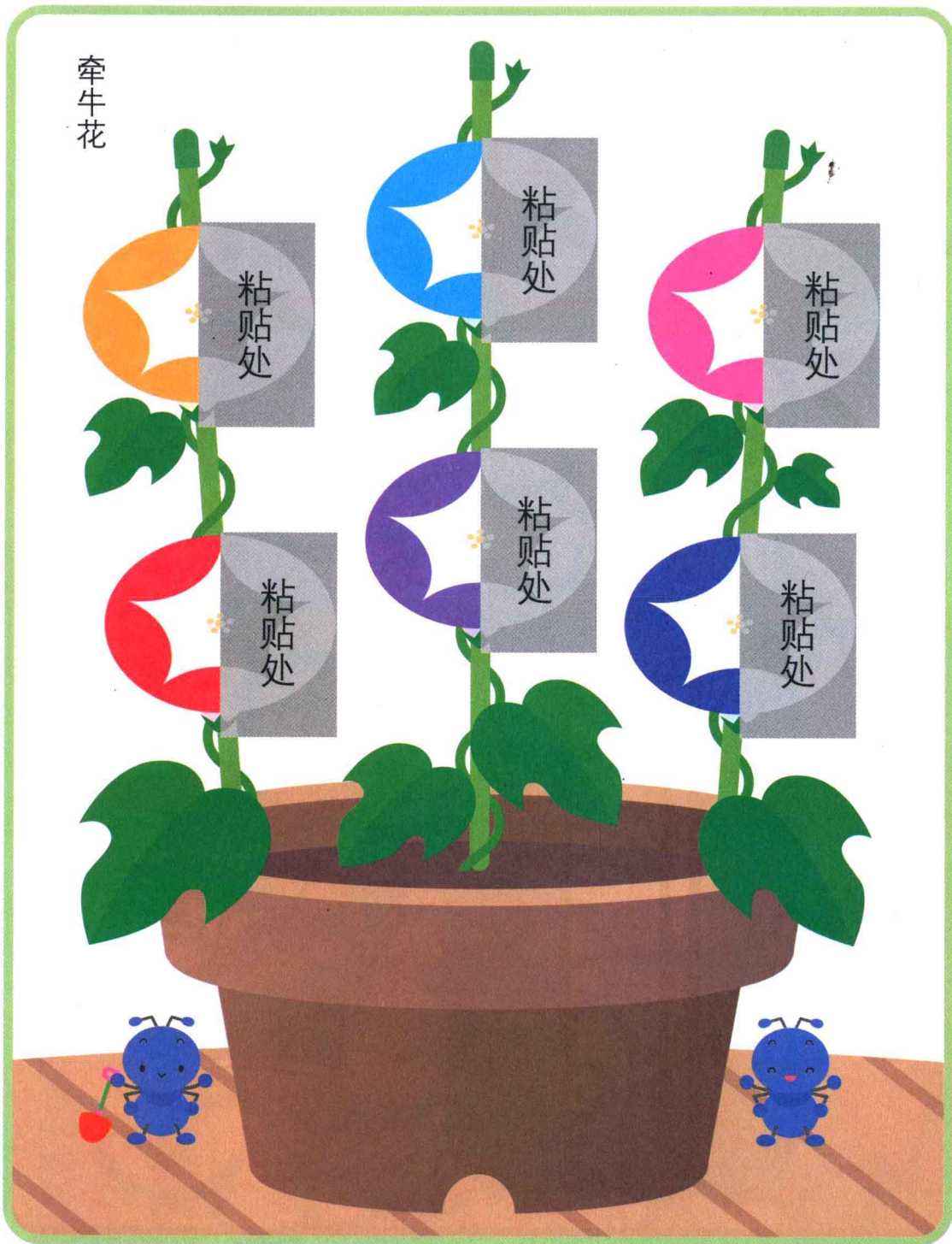

试着写一写吧！

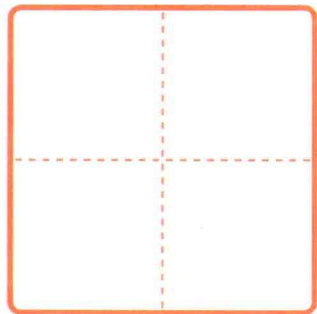

文字

		姓名
月	日	



描一描下面的文字吧！

用线连一连，使文字与图片相吻合吧！

尺

书

伞

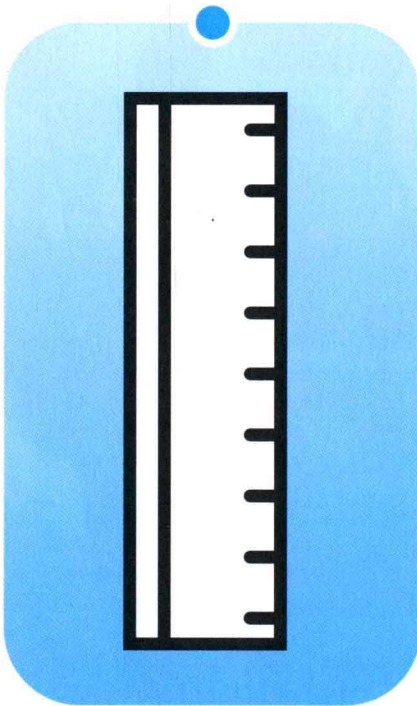

数量 · 走迷宫

月	日	姓名
---	---	----



边给海鸥画○数数，边从 走到 吧！
 海鸥的数量一共是多少呢？



描一描吧！

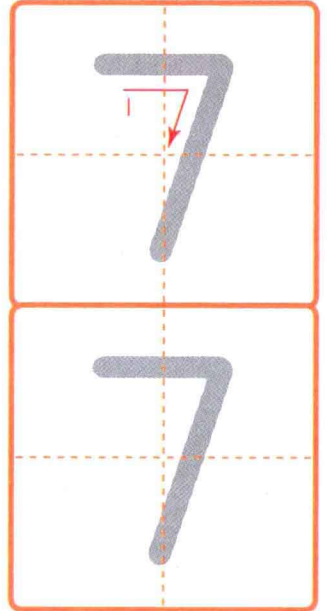

试着写一写吧！

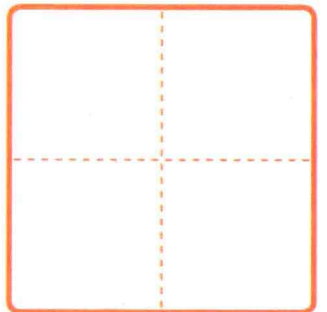

姓名

月

日

你真棒

奖励
贴纸

读一读、背一背古诗吧！

悯农 [唐]李绅

锄禾日当午，
汗滴禾下土。
谁知盘中餐，
粒粒皆辛苦。



数量与数字

		姓名
月	日	



描一描下面的数字吧!

并给相等数量的贝壳涂上自己喜欢的颜色吧!

例



		姓名
月	日	



给西瓜贴上西瓜子吧！西瓜子的数量一共是多少呢？

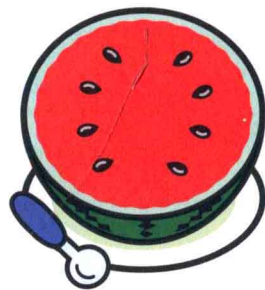

描一描吧！

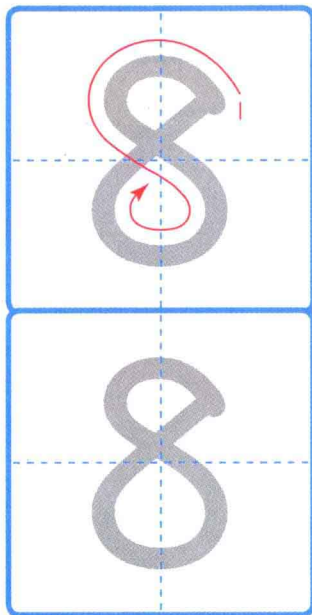

试着写一写吧！

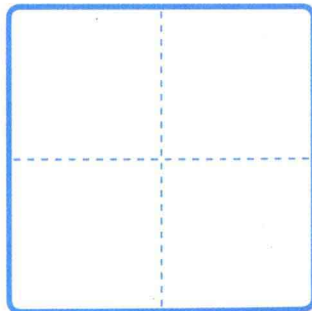

数量·走迷宫



姓名

月

日

你真棒

奖励
贴纸

边数一数昆虫的数量边从  走到  吧!
昆虫的数量一共是多少呢?

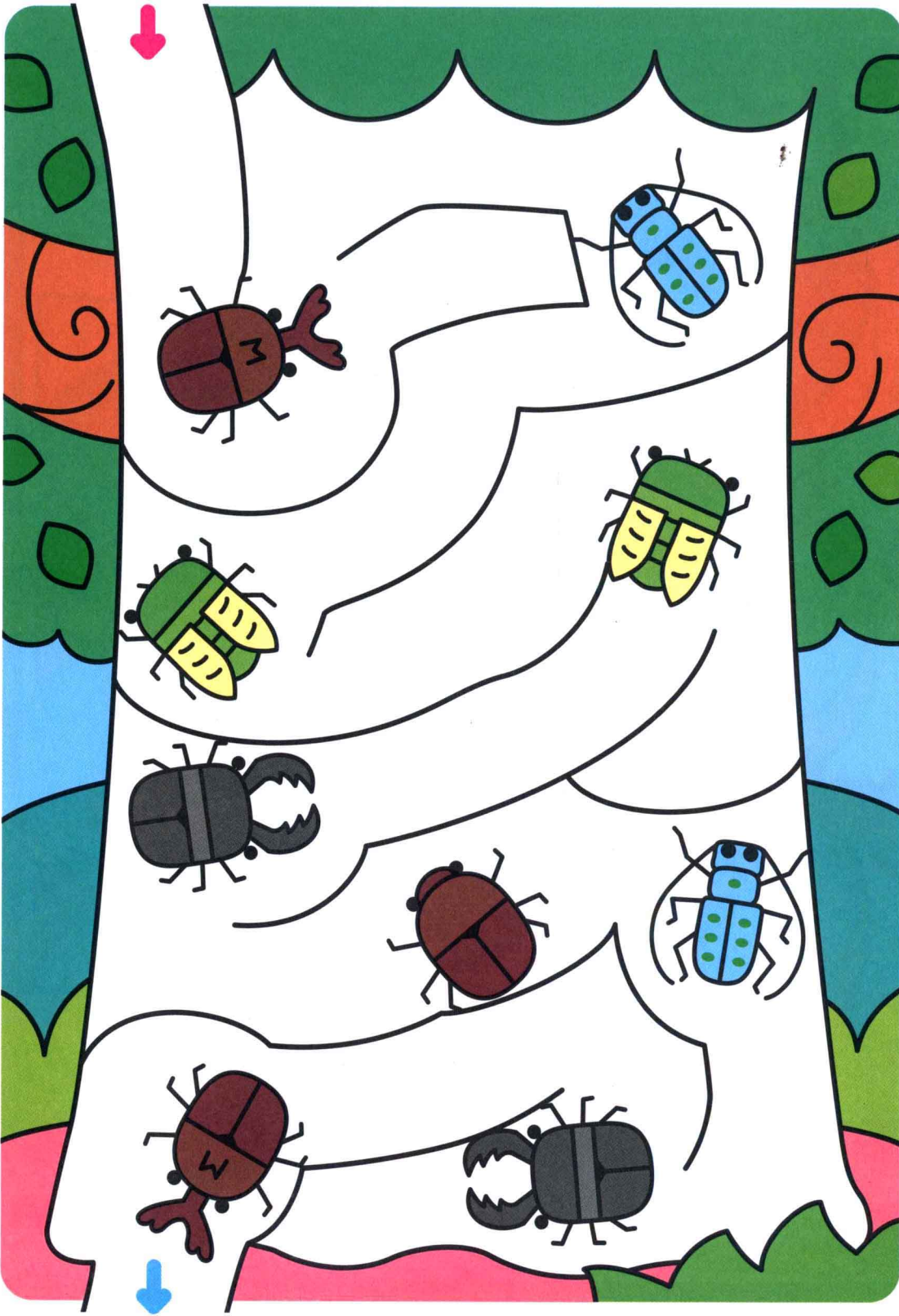

描一描吧!

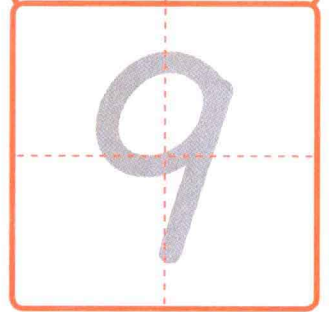
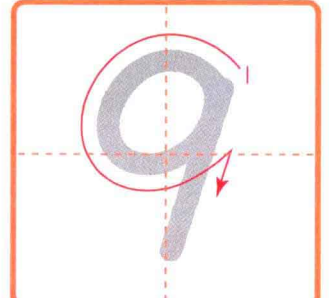

试着写一写吧!

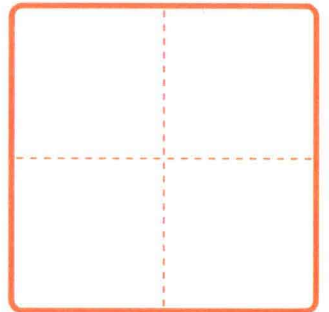



		姓名
月	日	



圈出属于十二生肖的动物吧!



鼠

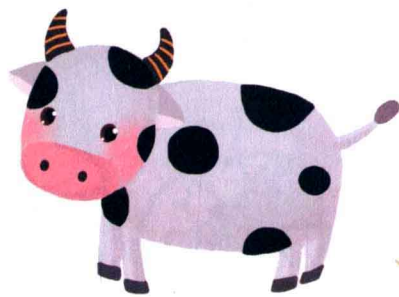

牛

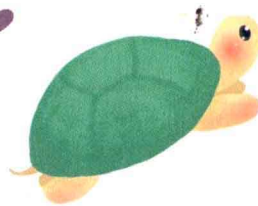

乌龟



兔子



猫

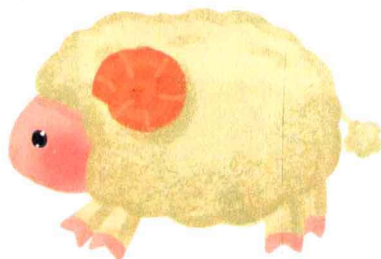

羊



鸡



蛇



龙



猴



鸭



猪



狗



象



虎



马



月		日		姓名
---	--	---	--	----



分别给“章”、“鱼”字的地方涂上红色和黑色吧！
最后会出现什么图像呢？



在田字格内描一描吧！

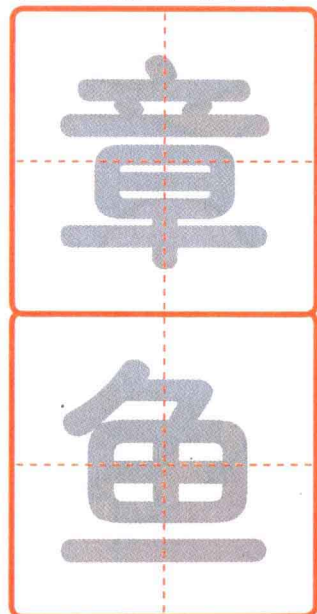



		姓名
月	日	



分别给“松”、“鼠”字的地方涂上棕色和黑色吧！
最后会出现什么图像呢？



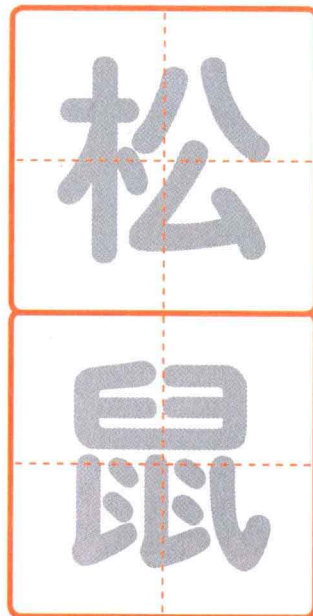

在田字格内描一描吧！



月	日	姓名
---	---	----



从  至 ，走一走银河迷宫吧！
别忘了贴上七夕装饰的贴纸哦！

