

手工坊 快乐生活巧编织系列

BIANZHI ZONGHE | 编织综合
DAHUICUI

大荟萃

3500

阿瑛 编



中国纺织出版社

 手工坊 快乐生活巧编织系列

编织综合大荟萃

3500

阿瑛 编



 中国纺织出版社

内 容 提 要

《编织综合毛衣大荟萃》顾名思义就是各类毛衣的集锦。本书以儿童毛衣、女士毛衣、男士毛衣为基础分为三类，共收录了五百余款毛衫，类型集活泼、时尚、实用、经典为一体，款式丰富多样，为编织爱好者提供了多样的选择。

图书在版编目 (CIP) 数据

编织综合大荟萃3500 / 阿瑛编. — 北京: 中国
纺织出版社, 2011. 9
(手工坊快乐生活巧编织系列)
ISBN 978-7-5064-7722-2

I. ①编… II. ①阿… III. ①毛衣—编织—图集
IV. ①TS941.763-64

中国版本图书馆CIP数据核字 (2011) 第143522号

策划编辑: 尚 绣 向 隽 责任编辑: 宗 静 责任印制: 刘 强
编 委: 刘 欢 褚 琼 尹 丹

中国纺织出版社出版发行
地址: 北京东直门南大街6号 邮政编码: 100027
邮购电话: 010-64168110 传真: 010-64168231
<http://www.c-textilep.com>
E-mail: faxing@c-textilep.com
长沙鸿发印务实业有限公司印刷 各地新华书店经销
2011年9月第1版第1次印刷
开本: 889×1194 1/16 印张: 17
字数: 150千字 定价: 35.80元
京东工商广字第0372号

凡购本书, 如有缺页、倒页、脱页, 由本社图书营销中心调换

CONTENTS

目录

- 001 精选实例
- 018 天真烂漫
- 047 时尚温婉
- 095 儒雅睿智
- 111 制作图解
- 260 钩织符号图解
- 263 编织符号图解

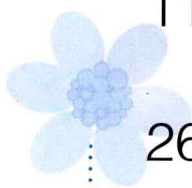

精选实例

JINGXUANSHILI



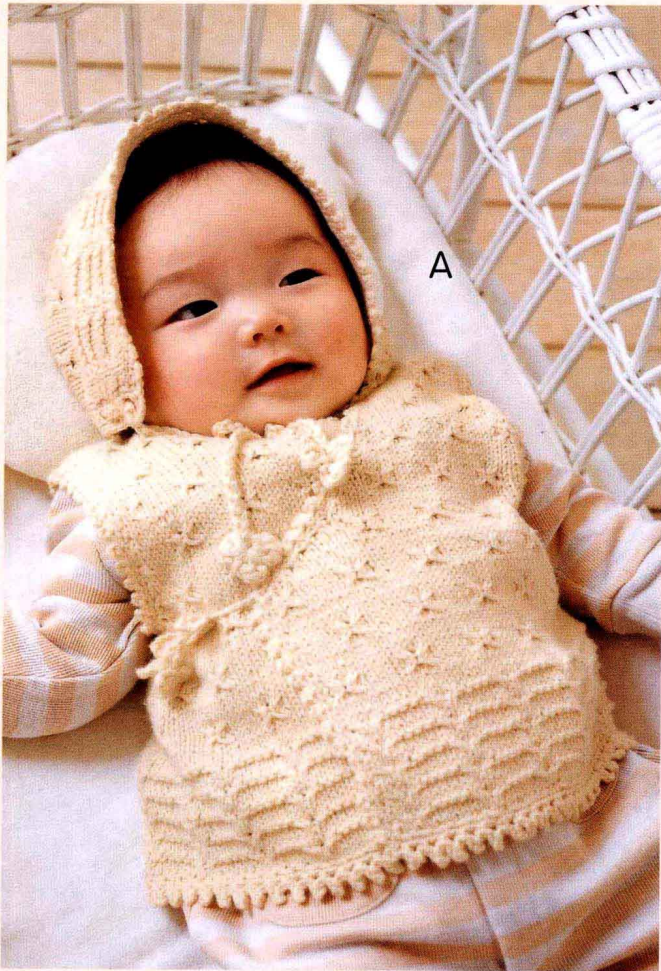

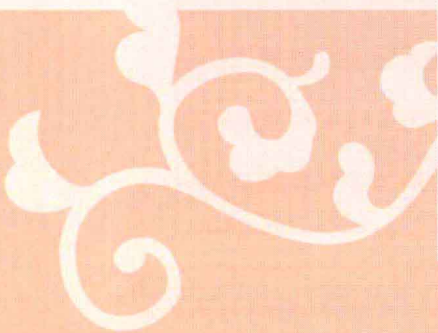

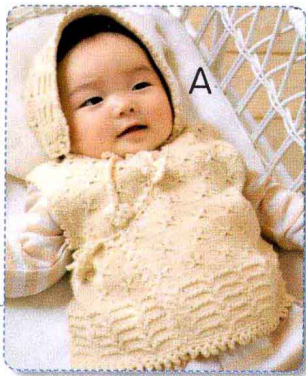

彩图见第2页

材料 中粗线米黄色140g(帽子40g、衣服100g)

工具 5号棒针, 5/0号、7/0号钩针

成品尺寸 衣服 胸围58cm、背肩宽23cm、衣长28.5cm

帽子 帽围37cm、帽深12.5cm

编织密度 花样编织A 25针X37行/10cm

花样编织B 25针X35行/10cm



B

彩图见第2页

材料 中粗线粉红色(蓝色)70g、白色25g,
15mmX10mm的鸭形纽扣1粒

工具 4号、6号棒针

成品尺寸 胸围57cm、背肩宽22cm、衣长28cm

编织密度 花样编织 22针X34行/10cm

A

结构图

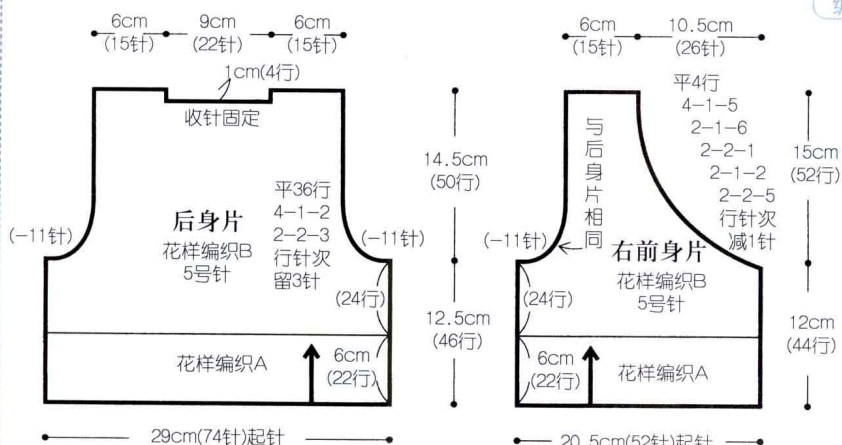

花样编织A、B

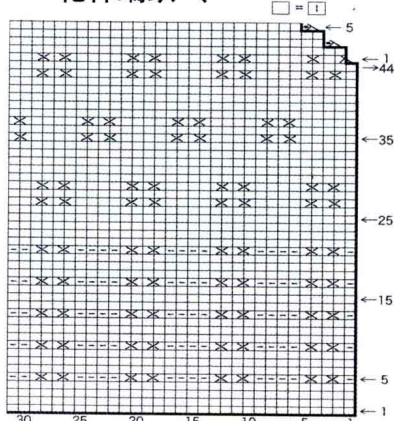

B

结构图

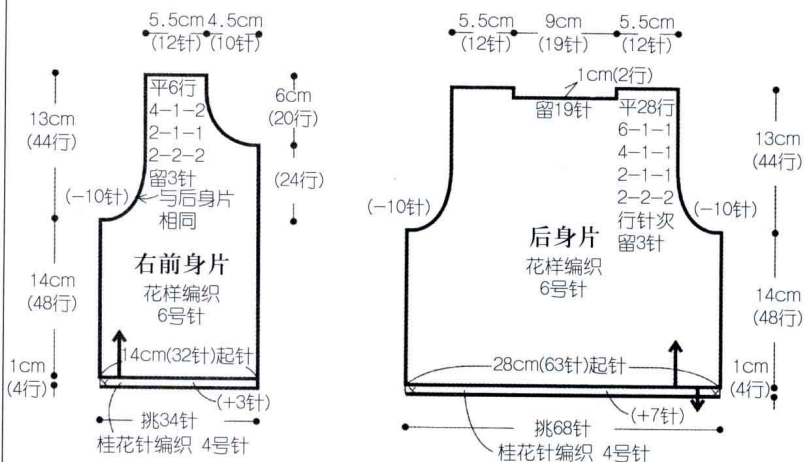

花样编织

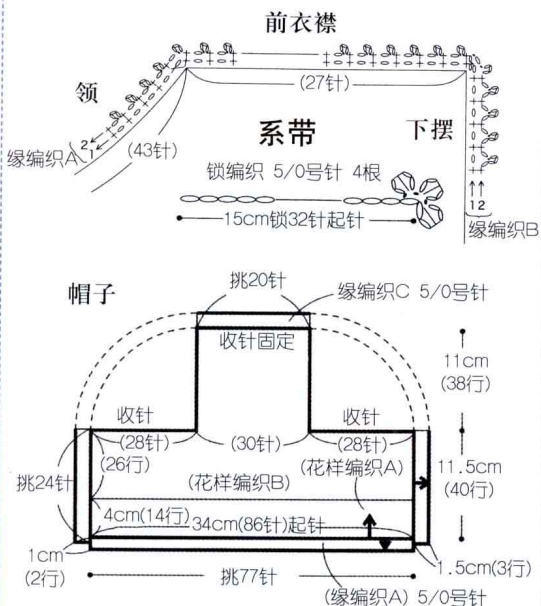
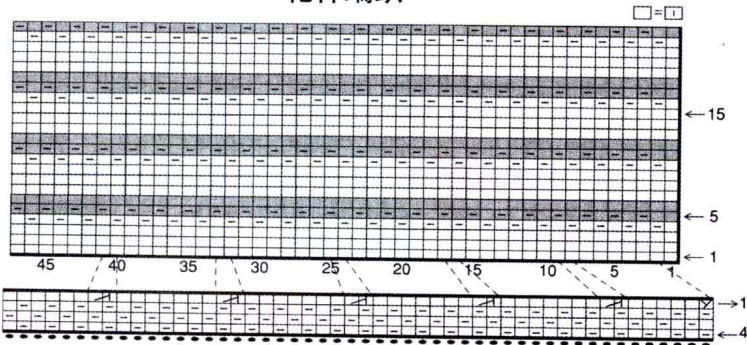

缘编织C

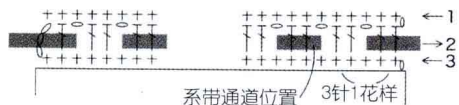

系带 7/0号针 2根

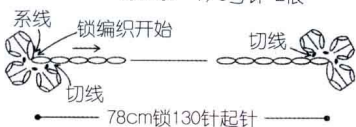

彩图见第3页

材料 中粗线浅茶色140g, 直径20mm的纽扣2粒、直径13mm的纽扣5粒

工具 5号棒针, 5/0号钩针

成品尺寸 胸围72cm、裤长40cm

编织密度 下针编织 21针X27.5行/10cm

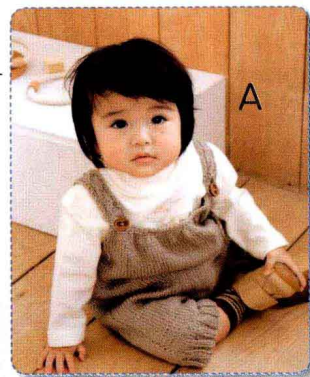

彩图见第3页

材料 中粗线灰色160g, 直径15mm的花形纽扣3粒

工具 6号、8号棒针

成品尺寸 胸围52cm、背肩宽20cm、衣长29cm、袖长21cm

编织密度 下针编织 19针X28行/10cm

单罗纹编织 25针X28行/10cm

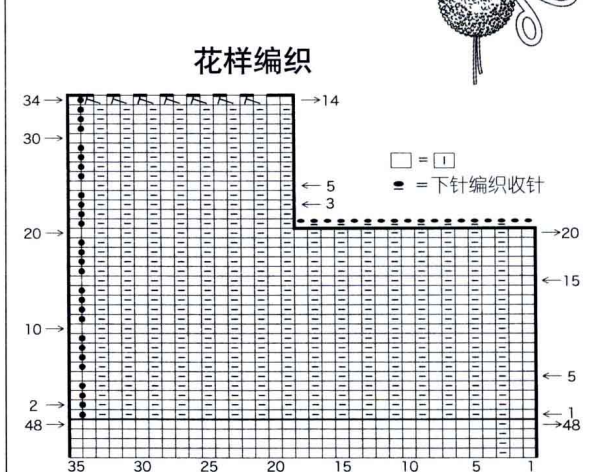
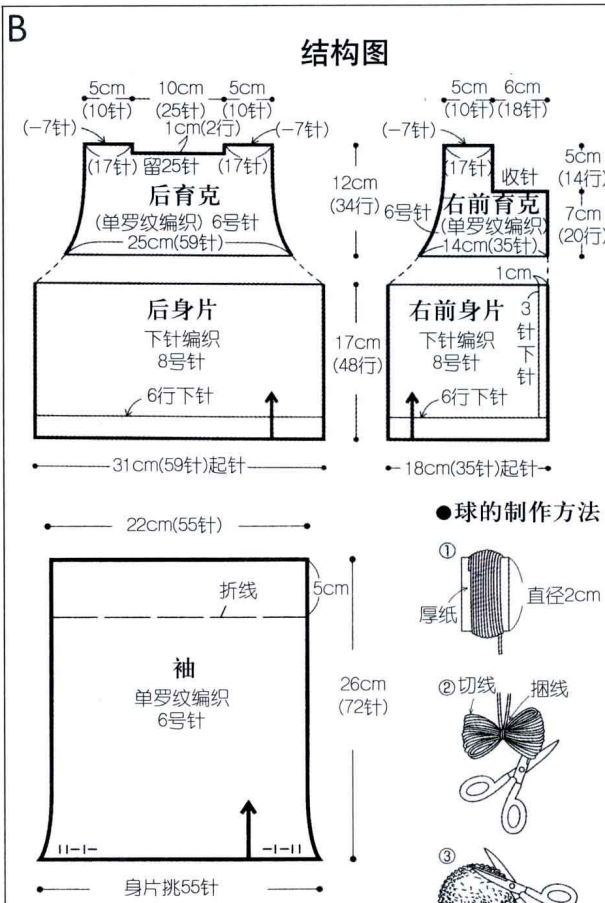
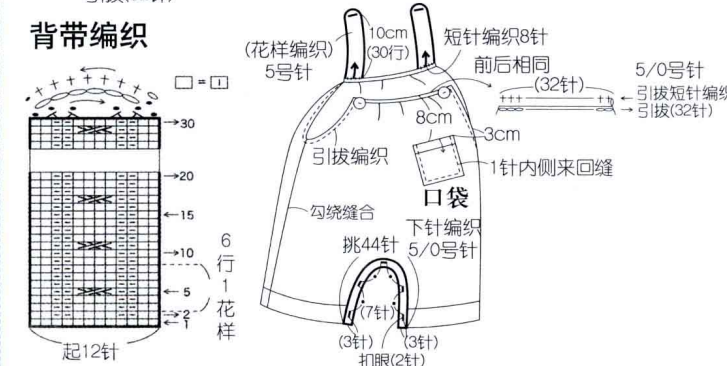
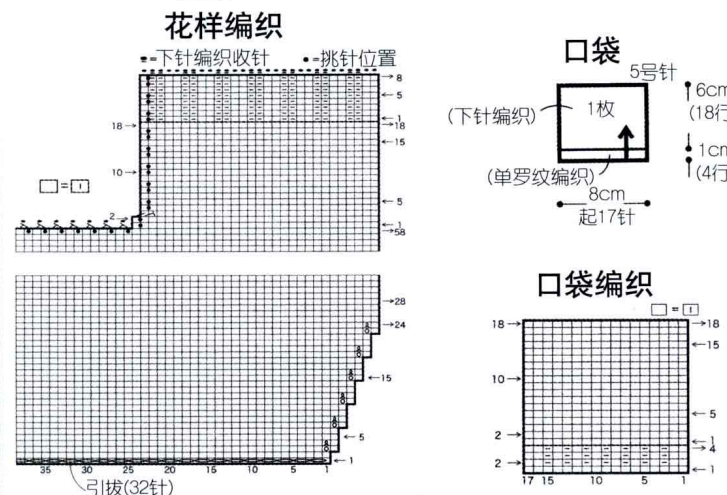
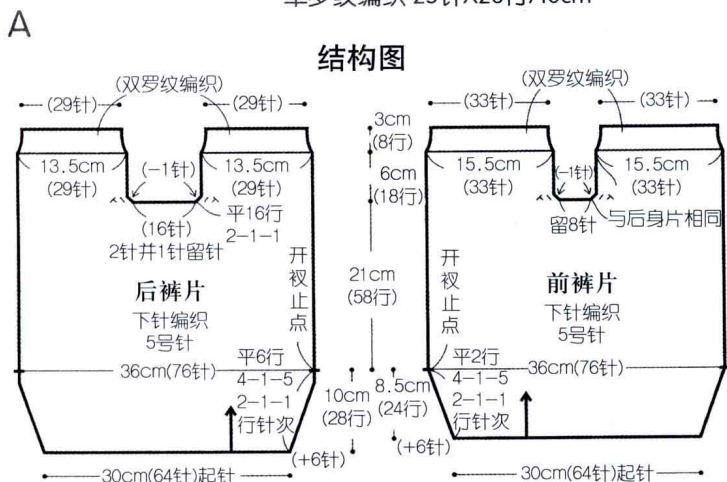



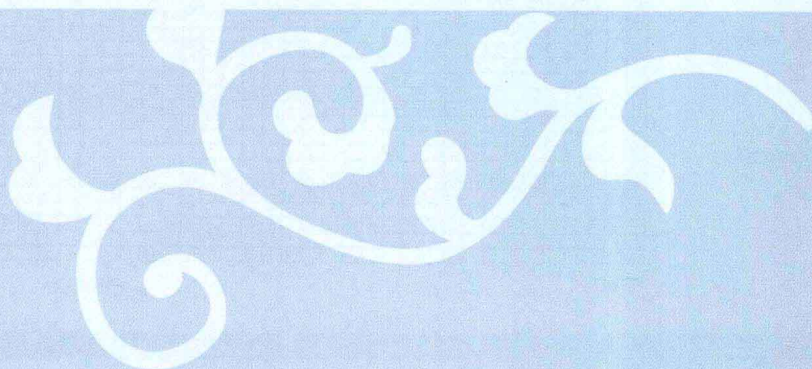



彩图见第6页

材料 中细线茶色185g

工具 4号、5号棒针

成品尺寸 胸围96cm、背肩宽36cm、衣长51.5cm、袖长41.5cm

编织密度 花样编织B 21.5针X36行/10cm

结构图

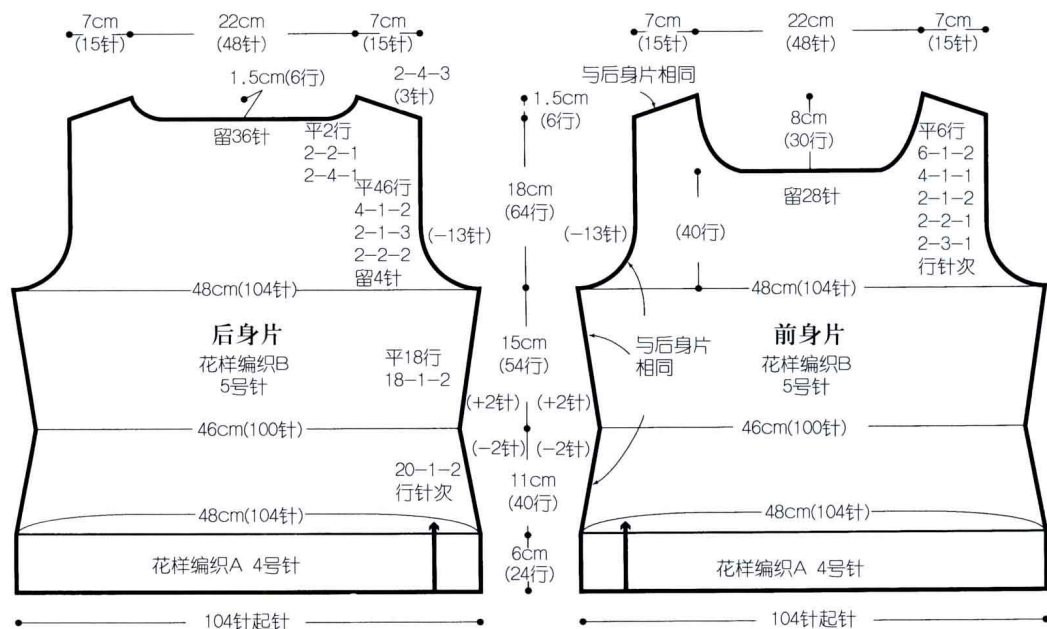

花样编织A、B

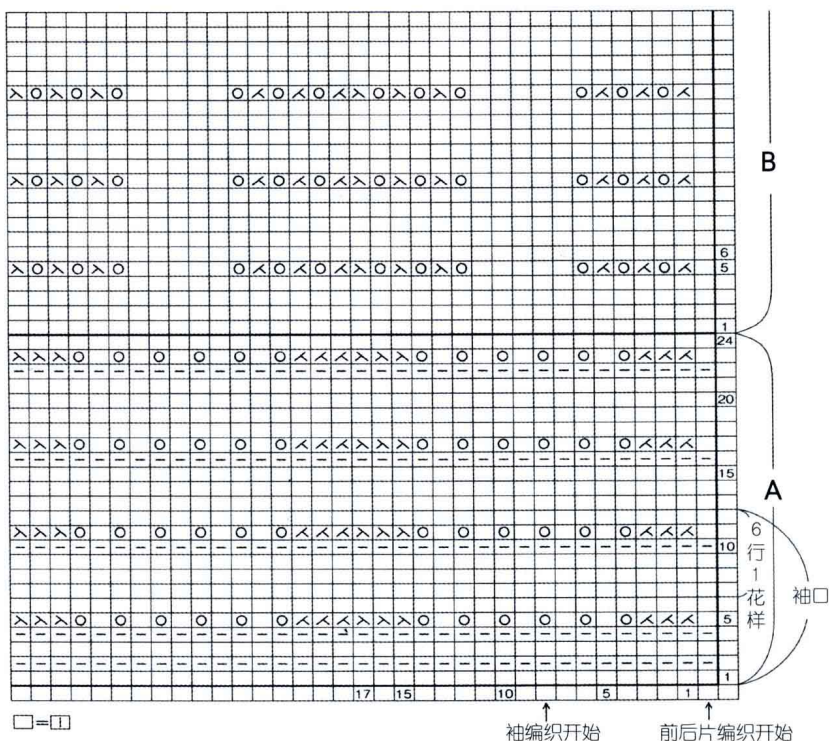
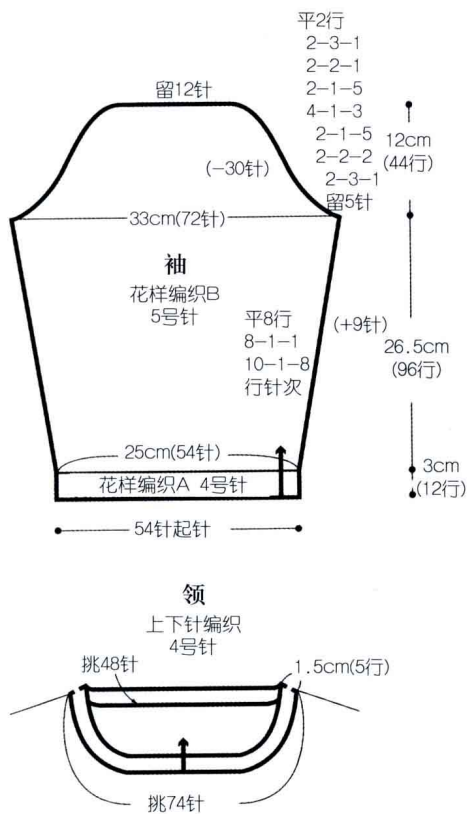

彩图见第7页

材料 中粗线米黄色365g, 直径12mm的纽扣2粒

工具 4/0号、5/0号钩针

成品尺寸 胸围92cm、衣长54cm、肩袖长56.5cm

编织密度 花样编织B 27.5针X12.5行/10cm



结构图

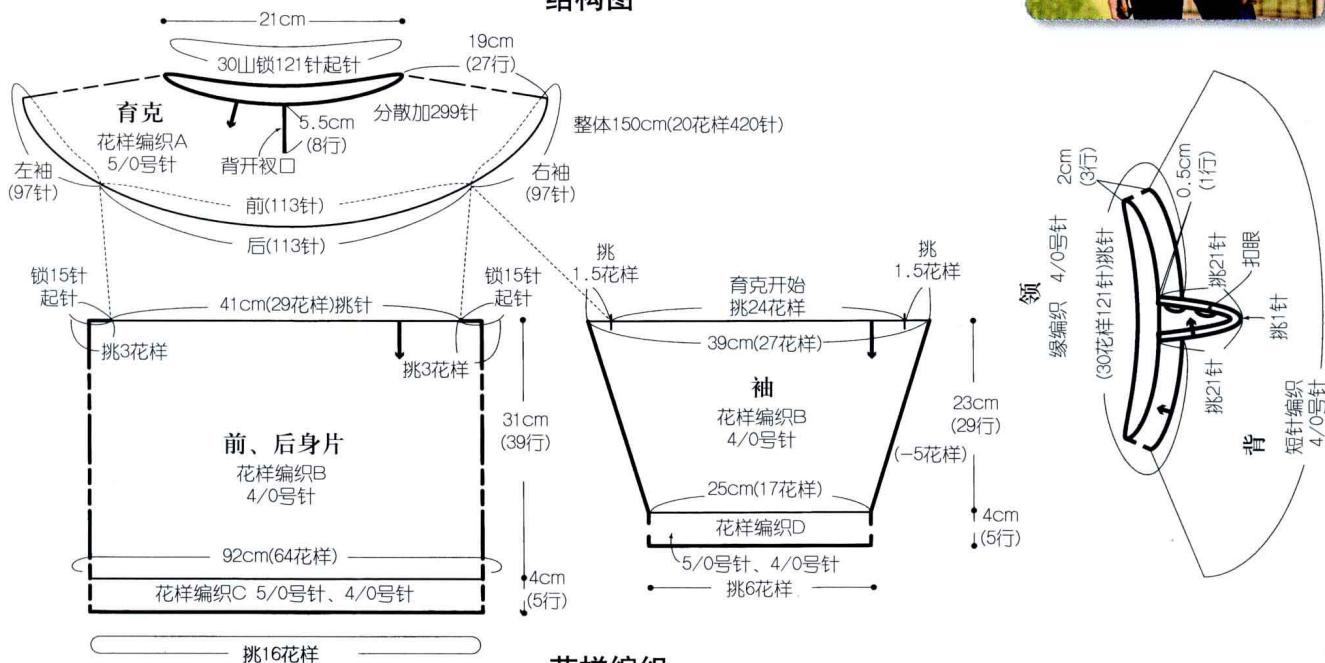

花样编织

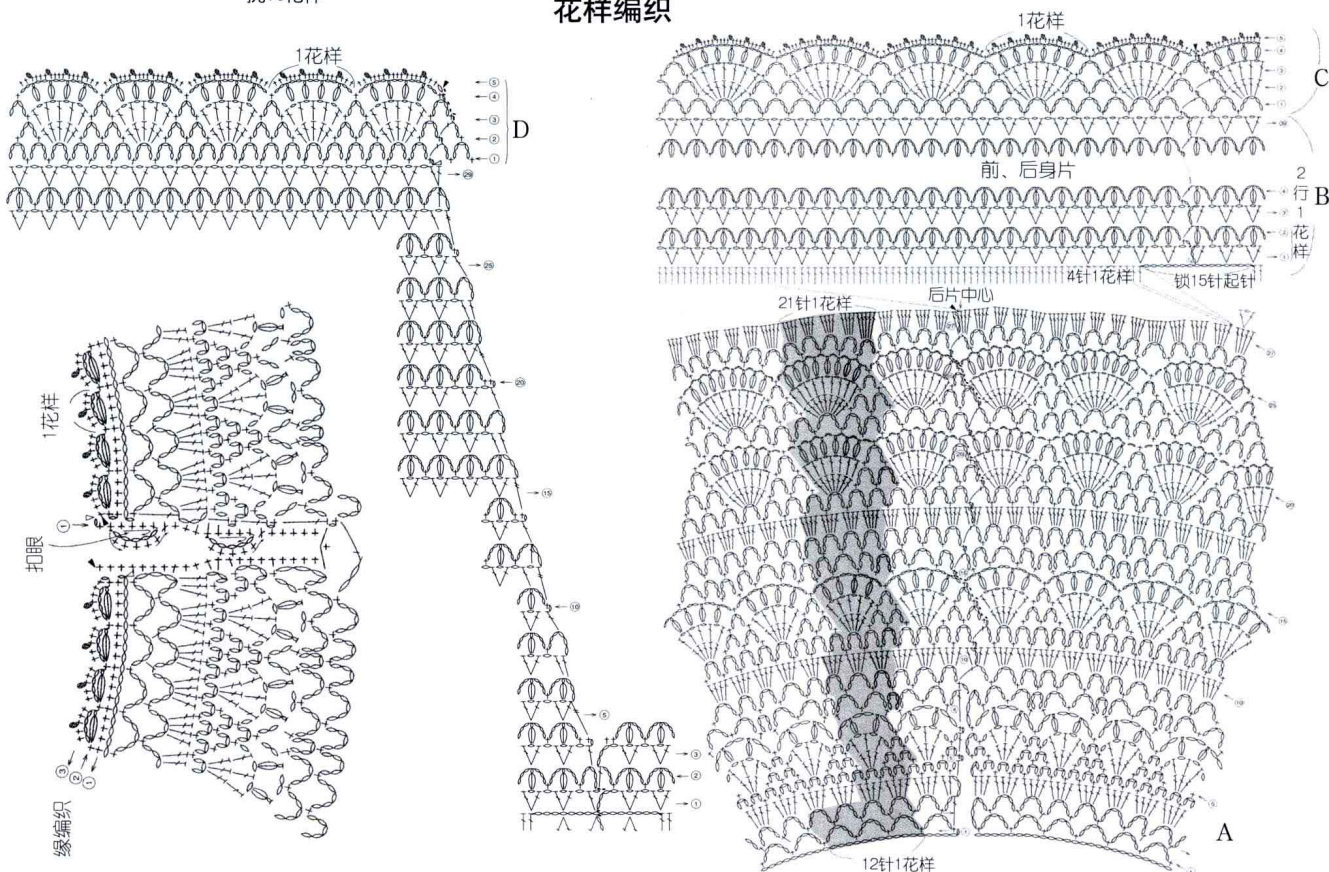



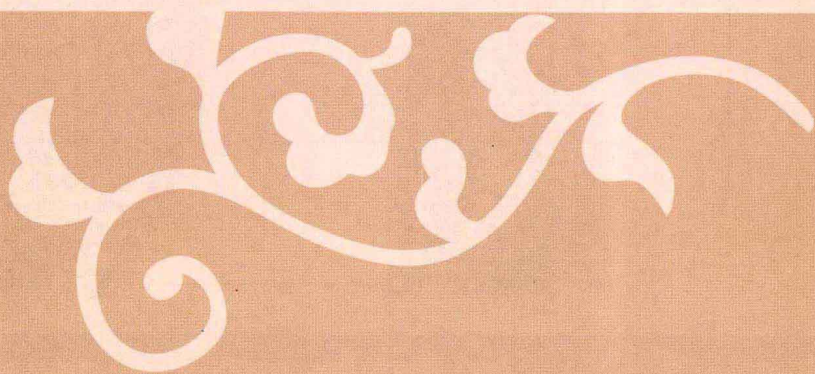



彩图见第10页

材料 中细线深紫色395g

工具 3/0号钩针

成品尺寸 胸围94cm、背肩宽37cm、衣长62cm、袖长54cm

编织密度 花样编织 1花样约为6cm、8行/10cm

结构图

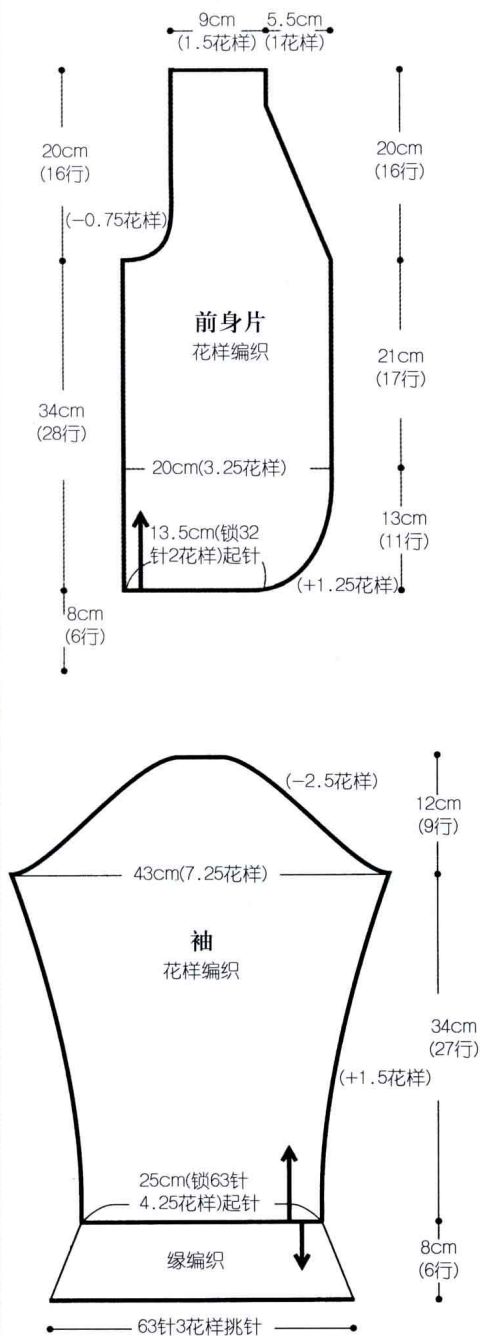

缘编织

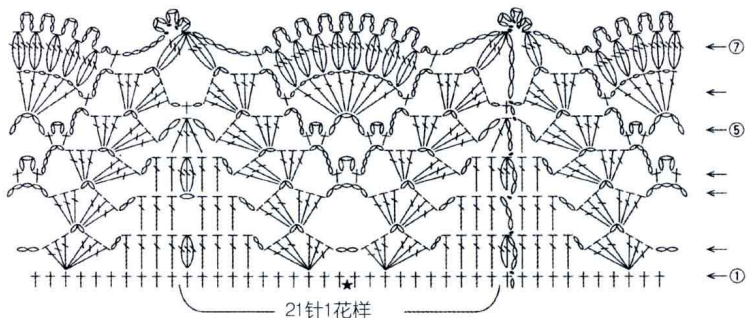

花样编织



后挑63针3花样
 8cm (7行)
 领、前衣襟、下摆
 缘编织

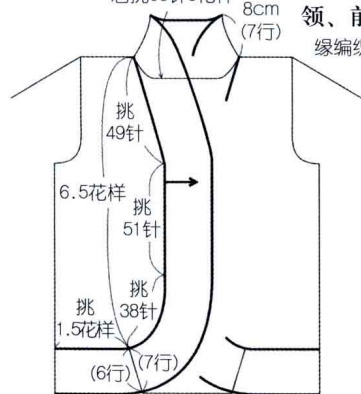

▷ = 系线

袖口

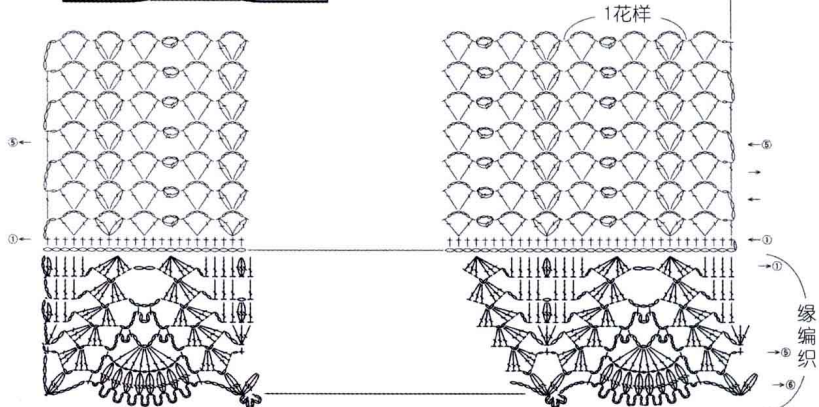

彩图见第11页

材料 中细线暗红色440g

工具 5号、6号棒针

成品尺寸 胸围92cm、背肩宽35cm、衣长59cm、袖长54.5cm

编织密度 上针编织 23针X29行/10cm
 花样编织 26针X29行/10cm



结构图

