

手工坊 快乐生活巧编织系列

BIANZHI YOUYA | 编织优雅
MAOYI HUICUI

毛衣荟萃

3500

阿瑛 编



中国纺织出版社

手工坊 快乐生活巧编织系列

编织优雅毛衣荟萃

3500

阿瑛 编



 中国纺织出版社

内 容 提 要

本书汇集了近五百多款中老年的毛衣款式，风格以优雅兼实用的中年女士毛衣与质朴典雅的老年毛衣为主打，为编织能手们提供了多样的选择。书中还附有详细的花样图解，让您能轻松地织出自己的所爱织物！

图书在版编目（CIP）数据

编织优雅毛衣荟萃3500 / 阿瑛编. — 北京：中国
纺织出版社，2011.9
（手工坊快乐生活巧编织系列）
ISBN 978-7-5064-7496-2

I. ①编… II. ①阿… III. ①毛衣—编织—图集
IV. ①TS941.763-64

中国版本图书馆CIP数据核字（2011）第084656号

策划编辑：尚 绣 郭 沫 责任编辑：魏 萌 责任印制：刘 强
编 委：刘 欢 褚 琼 黄 婷

中国纺织出版社出版发行
地址：北京东直门南大街6号 邮政编码：100027
邮购电话：010-64168110 传真：010-64168231
<http://www.c-textilep.com>
E-mail: faxing@c-textilep.com
长沙鸿发印务实业有限公司印刷 各地新华书店经销
2011年9月第1版第1次印刷
开本：889×1194 1 / 16 印张：17
字数：150千字 定价：35.80元
京东工商广字第0372号

凡购本书，如有缺页、倒页、脱页，由本社图书营销中心调换

CONTENTS

目录

- 001 精选实例
- 018 雅致风尚
- 079 质朴风尚
- 111 制作图解
- 266 钩织符号图解
- 268 编织符号图解

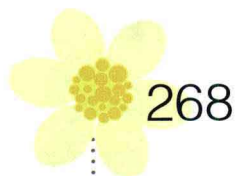

精选实例

JINGXUAN SHILI









彩图见第2页

材料 中粗深灰色系段染线480g

工具 6/0号钩针

成品尺寸 半径47cm、肩袖长47cm

编织密度 花样编织 21针X9行/10cm

结构图

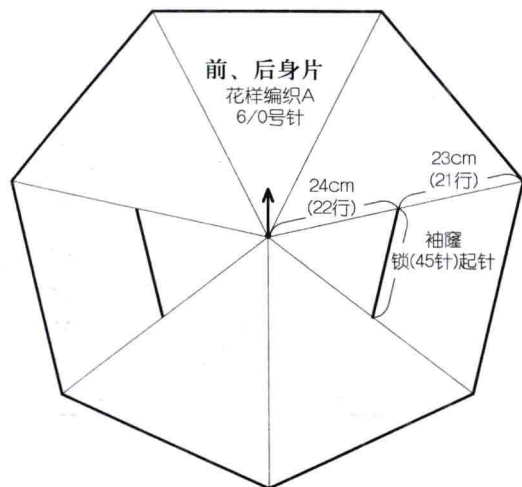

袖

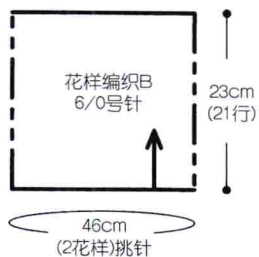

花样编织A

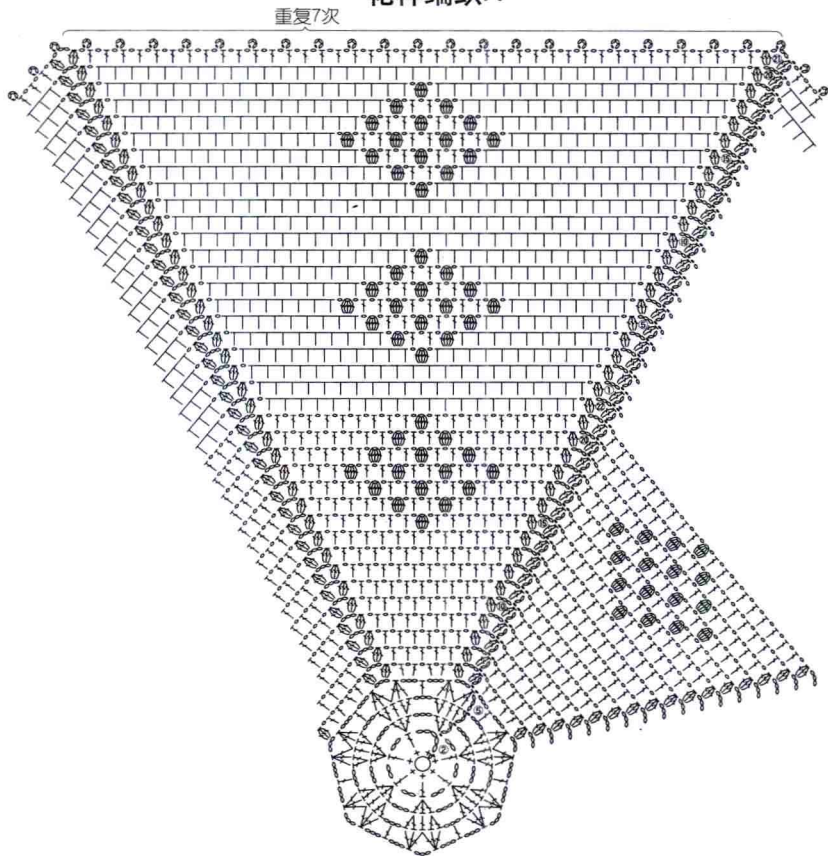

袖窿的编织方法

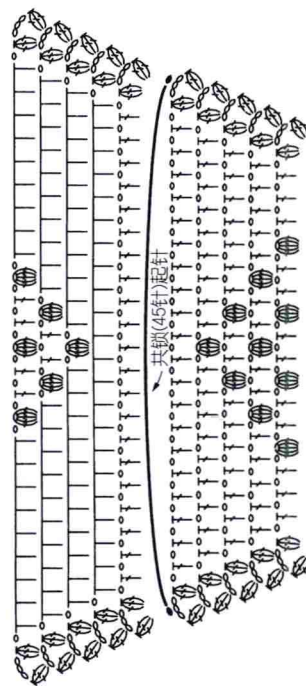

花样编织B

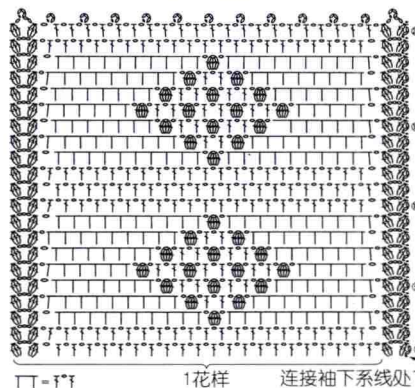

彩图见第3页

材料 中细乳白色羊毛绒线290g

工具 5/0号钩针

成品尺寸 胸围92cm、衣长42.5cm、肩袖长68.5cm

编织密度 花样编织 23.5针X10.5行/10cm



结构图

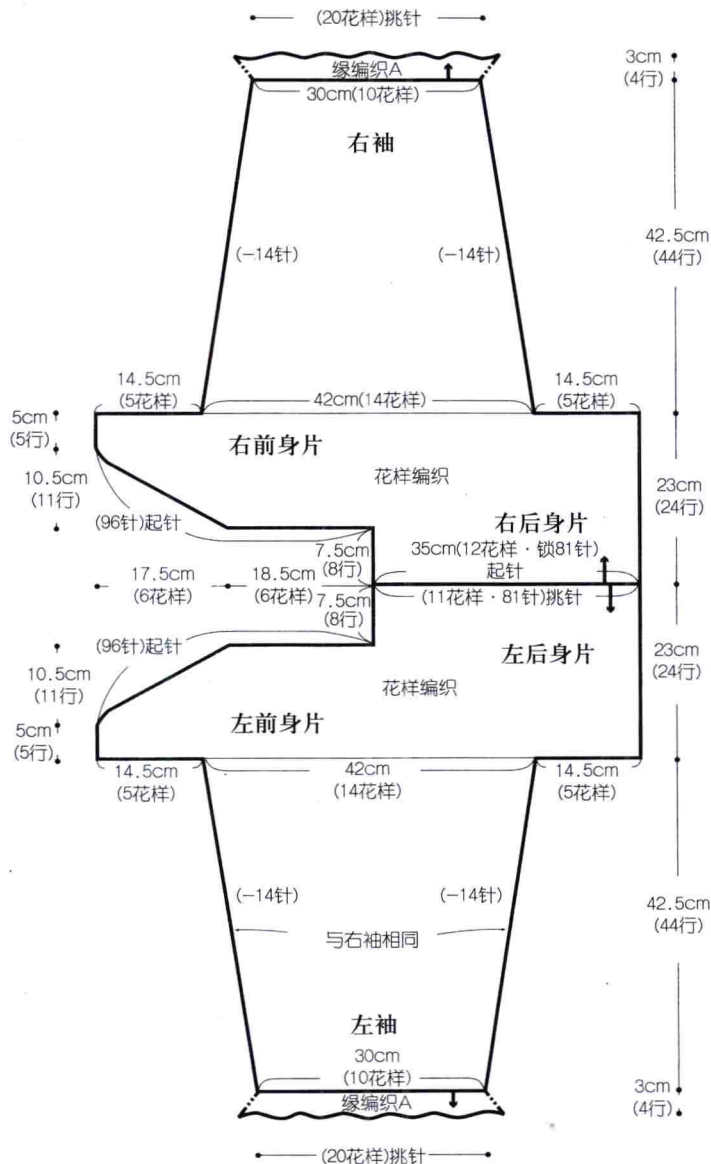

花样编织

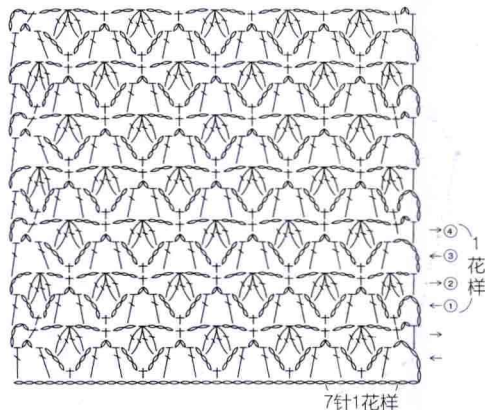

缘编织A

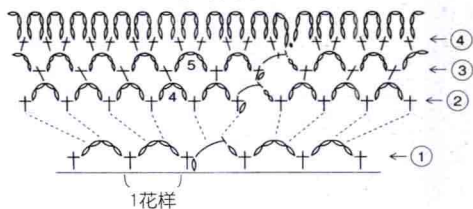

下摆、前衣襟、领

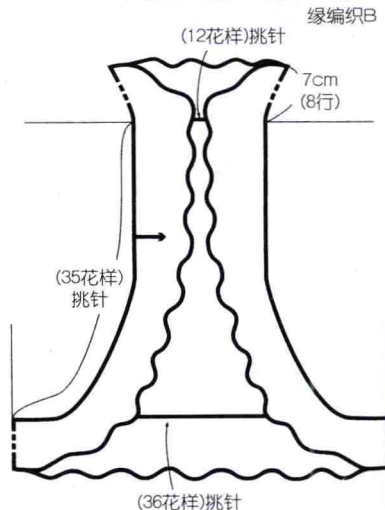

缘编织B

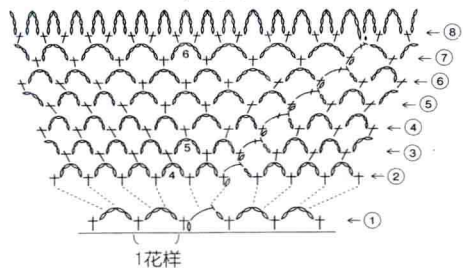







彩图见第6页

材料 中细暗红色、紫色系段染线230g

工具 4/0号、5/0号钩针

成品尺寸 胸围90cm、背肩宽45cm、衣长42cm、袖长36cm

编织密度 花样编织 27针(4.5花样)X9行/10cm

结构图

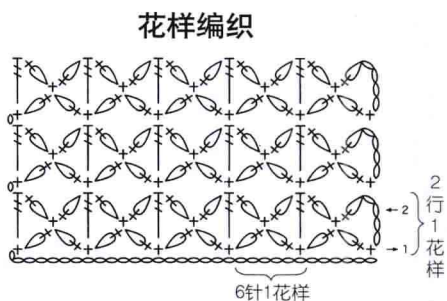
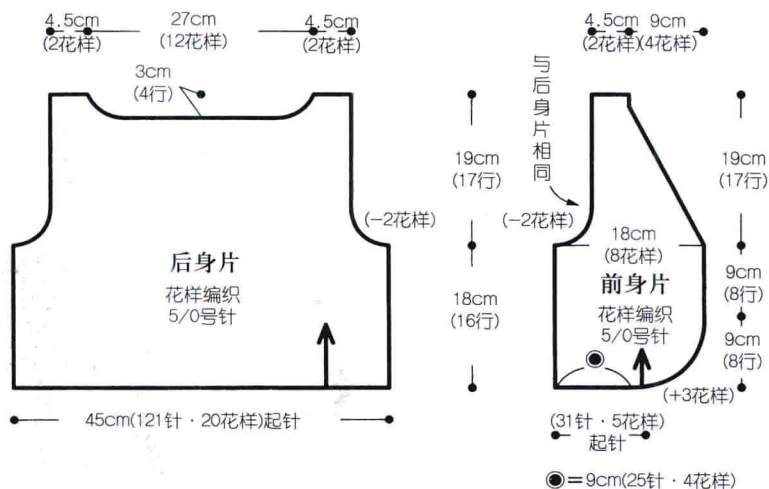

袖

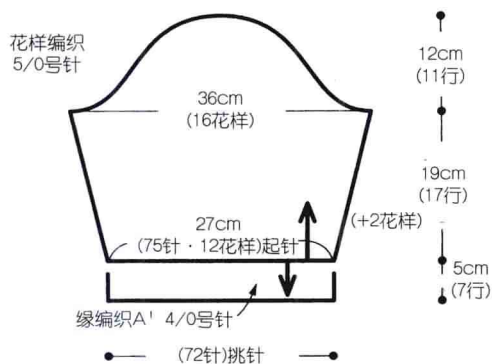

领、前衣襟、下摆
缘编织A 4/0号针

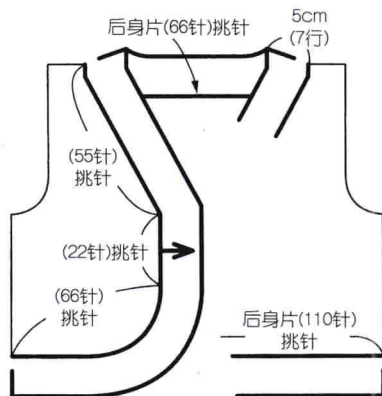

缘编织A

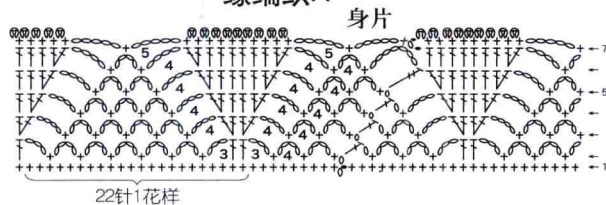

缘编织A'

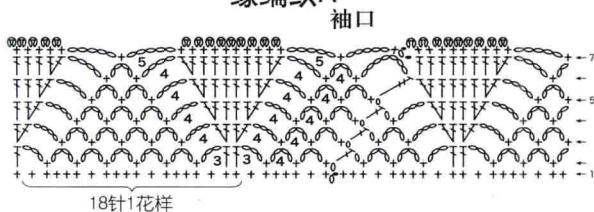

彩图见第7页

材料 中细米黄色线380g, 直径为1.5cm的纽扣6颗

工具 4号、5号棒针, 4/0号钩针

成品尺寸 胸围97.5cm、背肩宽35cm、衣长53.5cm、袖长53cm

编织密度 花样编织A 27针X30行/10cm
 花样编织B 25针X30行/10cm



结构图

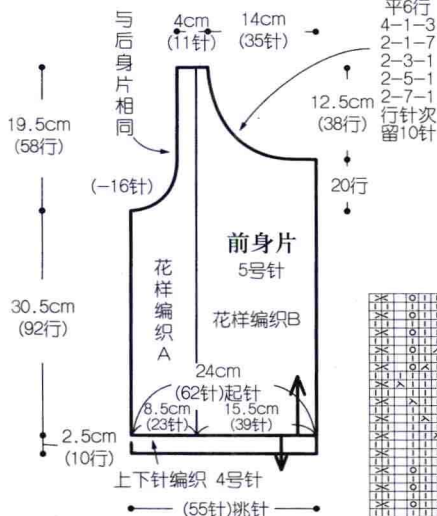
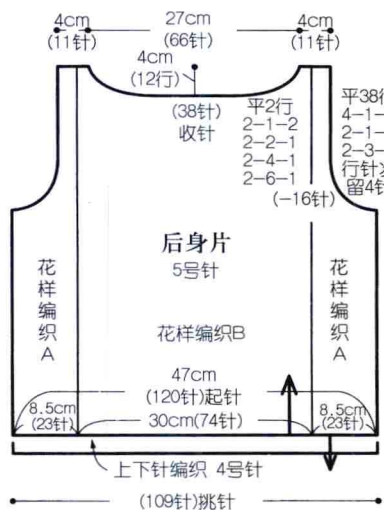

花样编织A

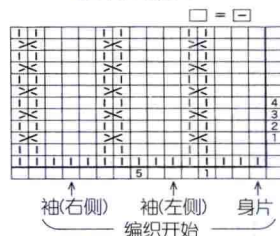

花样编织B

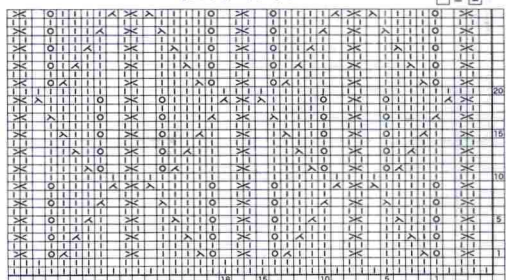

袖

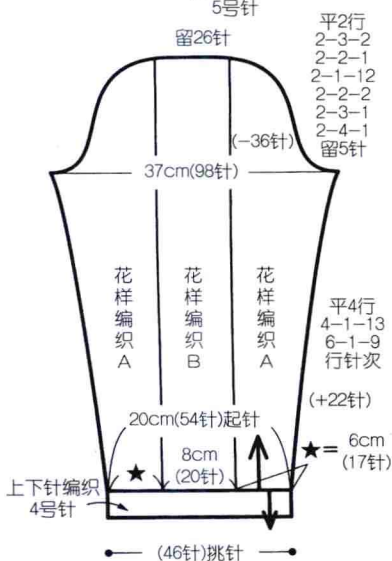

育克·前衣襟

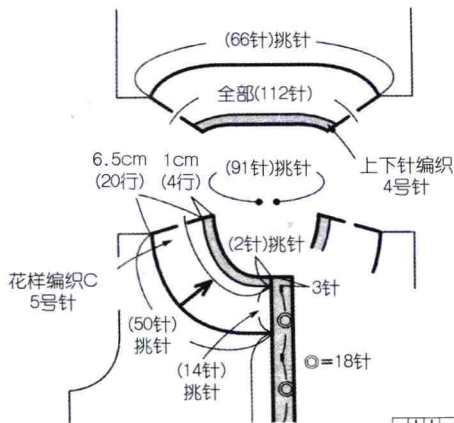

缘编织

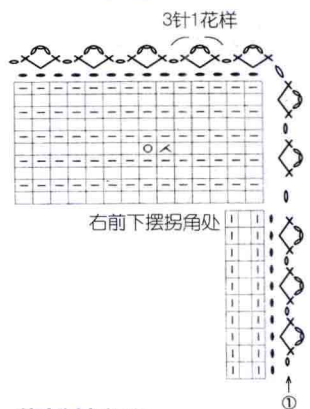

扣眼编织·上下针编织

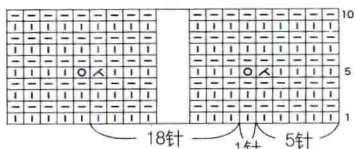

花样编织C

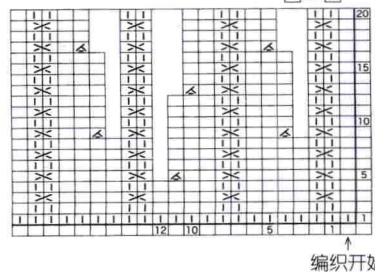







彩图见第10页

材料 中细淡紫色棉线450g

工具 4号、6号、7号棒针

成品尺寸 胸围96cm、背肩宽34cm、衣长57.5cm、袖长52.5cm

编织密度 花样编织B 22针X28.5行/10cm
 花样编织C 23针X27行/10cm

结构图

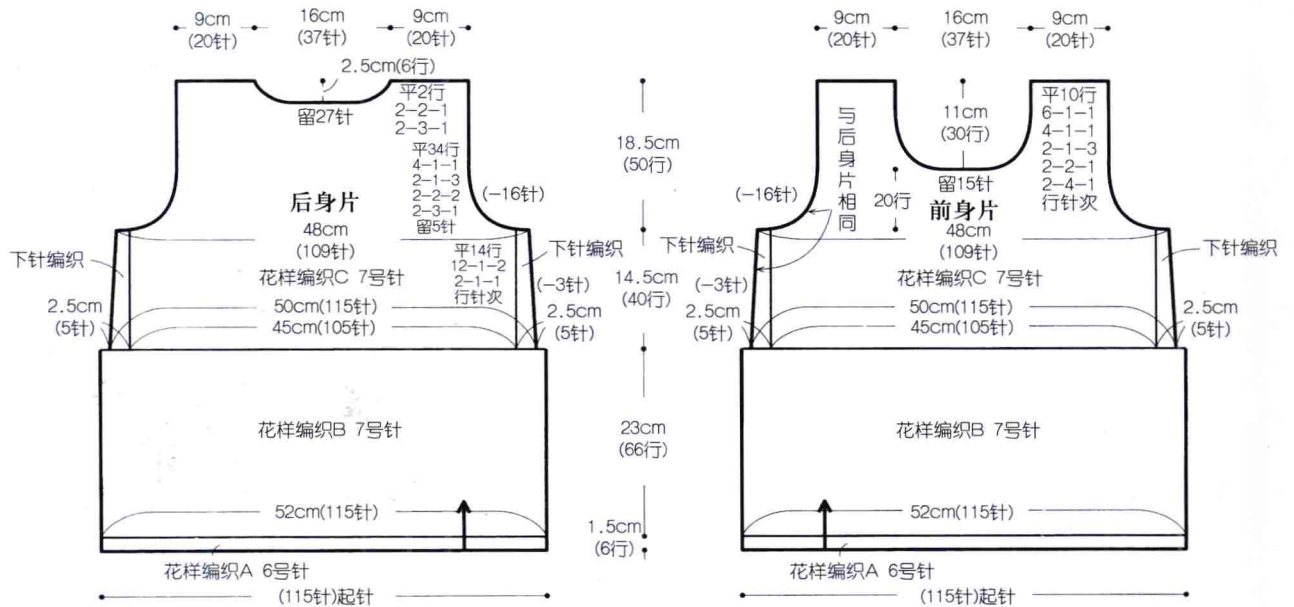

花样编织A、B

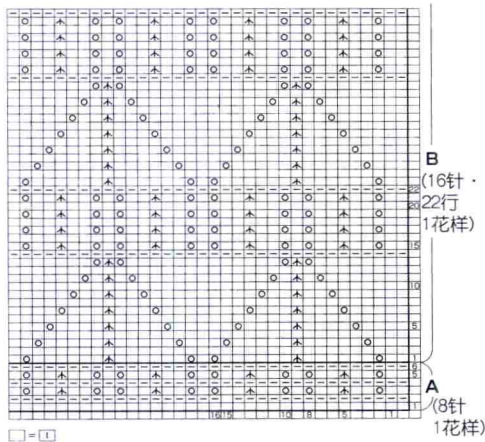

花样编织C

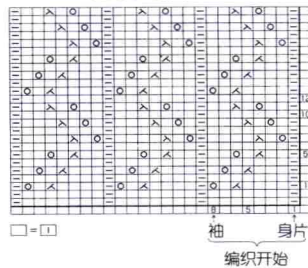

领

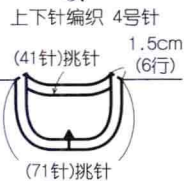

袖

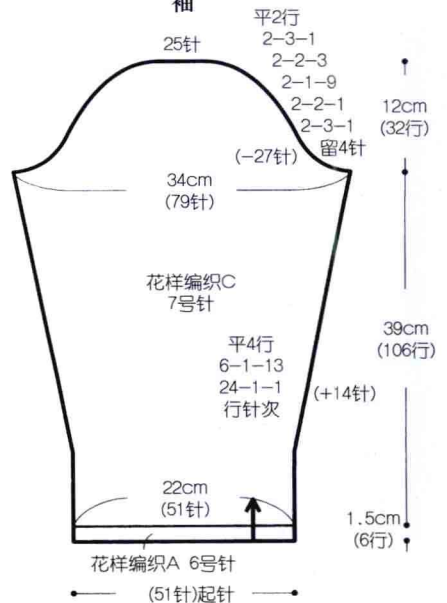

彩图见第11页

材料 中细浅紫色丝棉绒线430g

工具 5/0号钩针

成品尺寸 围度122cm、衣长61cm

编织密度 中心花样 6cmX5.5cm



花样编织

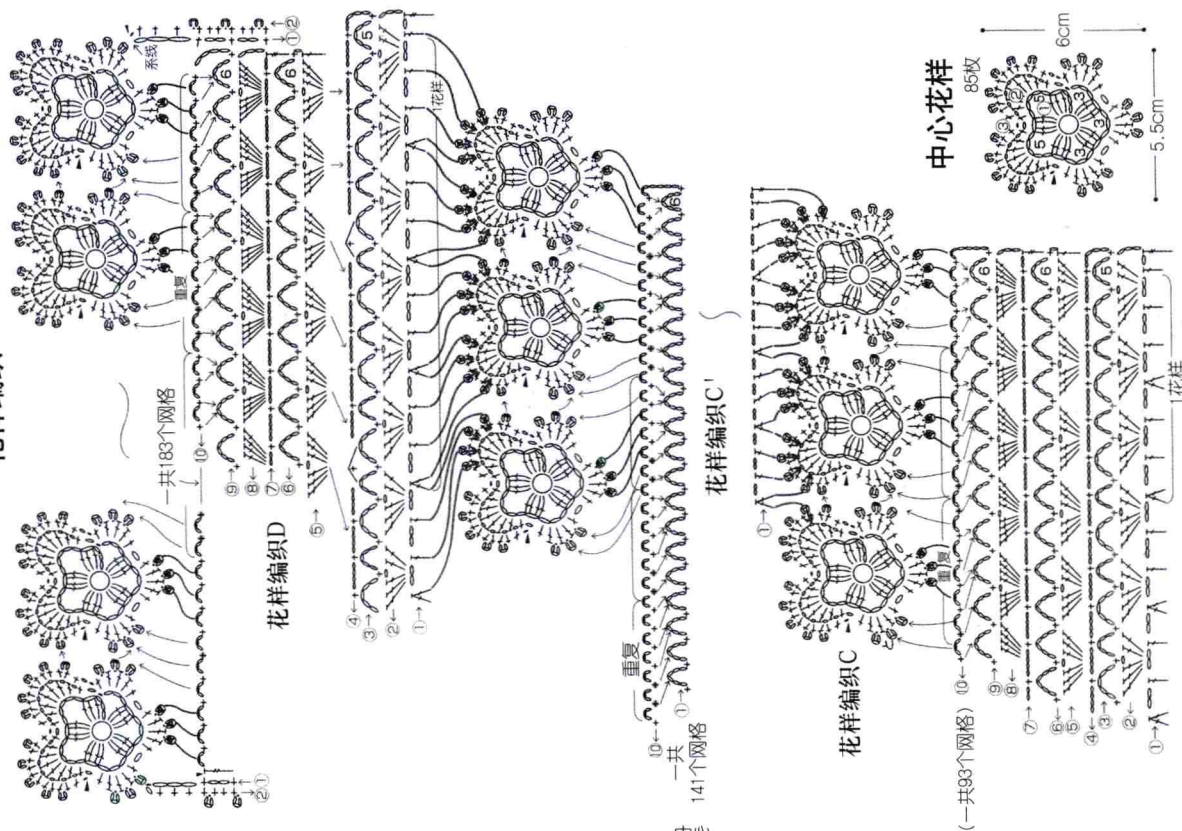

结构图

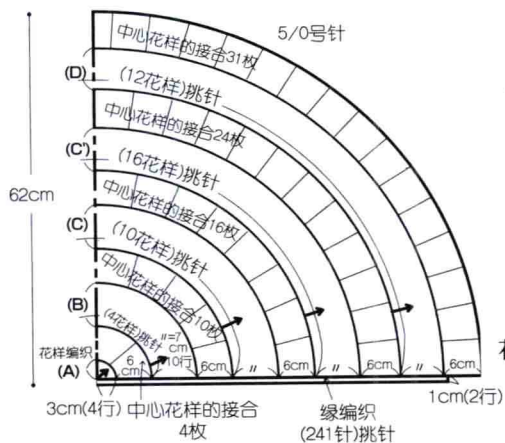

缘编织

第10行的短针，第9行开始在有挑1针(●)和挑2针的地方进行编织。挑针的方法从披肩的中心对称编织。

