

# 新式童装

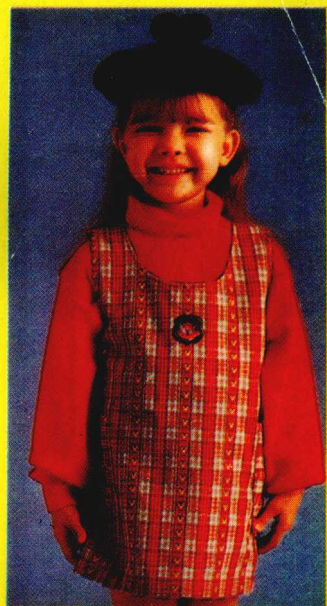

(沪)新登字104号

责任编辑：何智明

封面设计：王建斌

版面设计：王建斌 冯根寿

---

新式童装自己做

本社编

---

上海文化出版社 出版、发行 上海绍兴路74号  
新华书店 经销 上海中华印刷厂印刷

开本787×1092 1/16 印张9 插页22 正文144面

1992年9月第1版 1992年9月第1次印刷

印数1—5,000册

---

ISBN7-80511-582-6/TS·90 定价：8.80元

本书作者:

王映法 王 燕 章 荔 鲍 峰

冯瑞昌 徐敏珍 毛文真

责任编辑: 何智明

封面设计: 王建斌

## 目 录

童装彩照

缝纫制作注意事项····· 1

制图符号说明····· 1

身长和年龄参考表····· 1







童装裁剪法····· 2



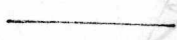



注: 彩照中标有“★”符号的童装附有缝纫制作图

# 缝纫制作注意事项

- (1) 具有缩水率的面料，裁剪前须先行缩水。
- (2) 裁剪前须识别面料的正反面，划粉应划在反面；划粉尽可能用白色或浅色。
- (3) 裁剪时一般先裁大件(前片、后片、袖片)，后裁小件(领、袋、挂面及其他配件)。
- (4) 男童服装一般都把钮洞开在左面(即锁眼子一面)；而女童服装则开在右面。
- (5) 裁剪图中的横直线之间，凡不另行加注的，均属互相垂直。
- (6) 灯芯绒要一顺裁。有图案的面料，图案要力求一致，左右要对称，上下不颠倒。格子面料要对准格子裁。
- (7) 本书介绍的所有裁剪制图，均是净缝，读者实际操作时，需加放做缝(俗称缝头)9毫米左右。
- (8) 在缝合的开始和结束一般都要在原线迹地方缝倒回针，以增强牢度。

## 制图符号说明

辅助线	
轮廓线	
连折线	
开刀展开	
直角	
等分	

缝纫线	
连接	
折裱	
折裱	
收拢	
等量	

## 身长和年龄参考表

身长(cm)	80~88	88~96	96~103	103~110	110~115
年 龄	1~2	2~3	3~4	4~5	5~6
115~120	120~125	125~130	130~135	135~140	140~145
6~7	7~8	8~9	9~10	10~11	11~12

年龄：2岁前后

身高：90厘米

用料：160厘米(门幅90厘米)

缝纫要点：①裤腰收裊后装橡筋，橡筋缉线要直。

②前片门襟和下摆的连接弧线要顺势。

③领片和衣片的拼接要注意领弧线的缝纫。

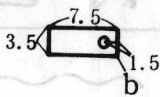
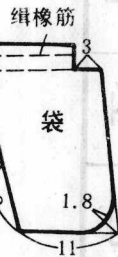
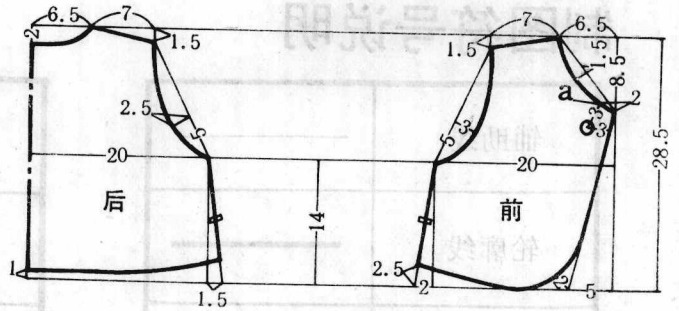
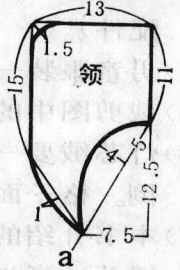
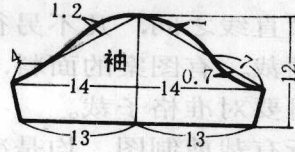
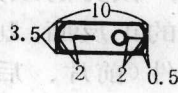

1

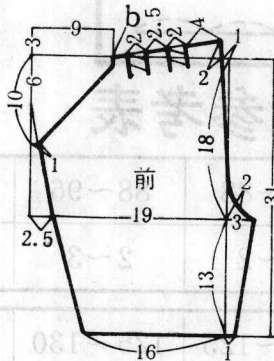

2

年龄：3~4岁

身高：96~103厘米

用料：110厘米(门幅90厘米)

缝纫要点：①前身开刀，贴袋袋底收二只袖。  
②后身开刀，收细袖。  
③袖口褶两只袖、装袖克夫。

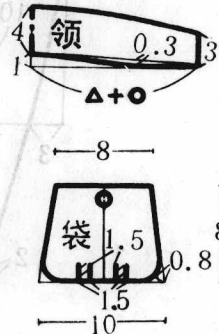
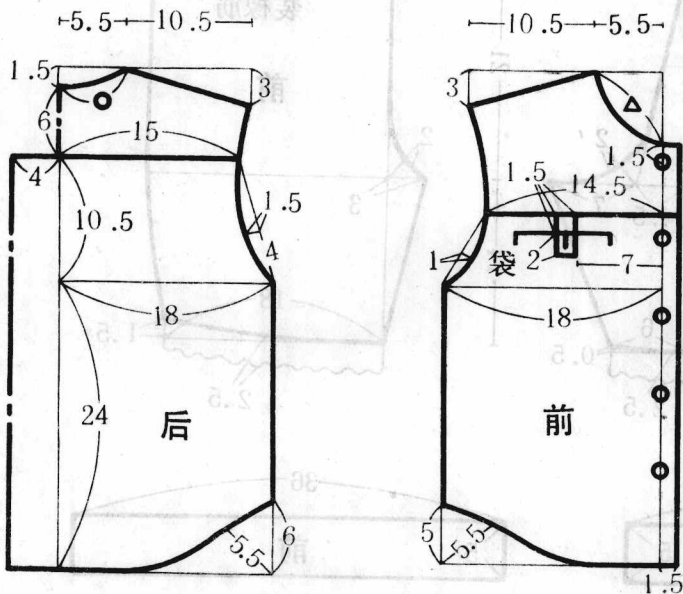
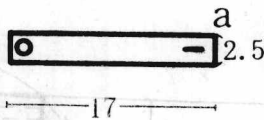
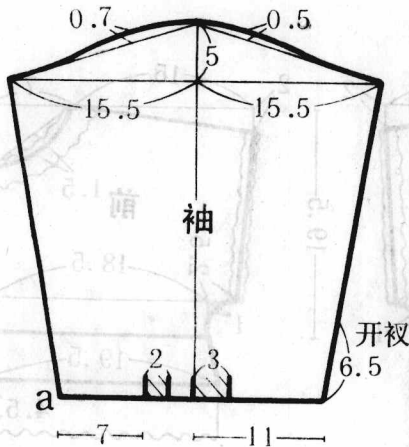
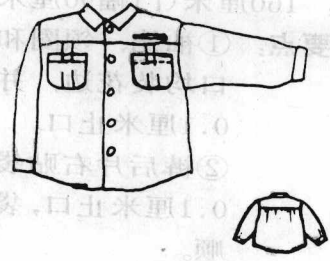

②

③

年龄：6~8岁

身高：110~115厘米

用料：160厘米(门幅90厘米)

缝纫要点：①袖笼、领圈和下摆、裤口均装花边，并在正面缉0.1厘米止口。

②裤后片右贴袋一只，缉0.1厘米止口，袋两圆角要顺。



③

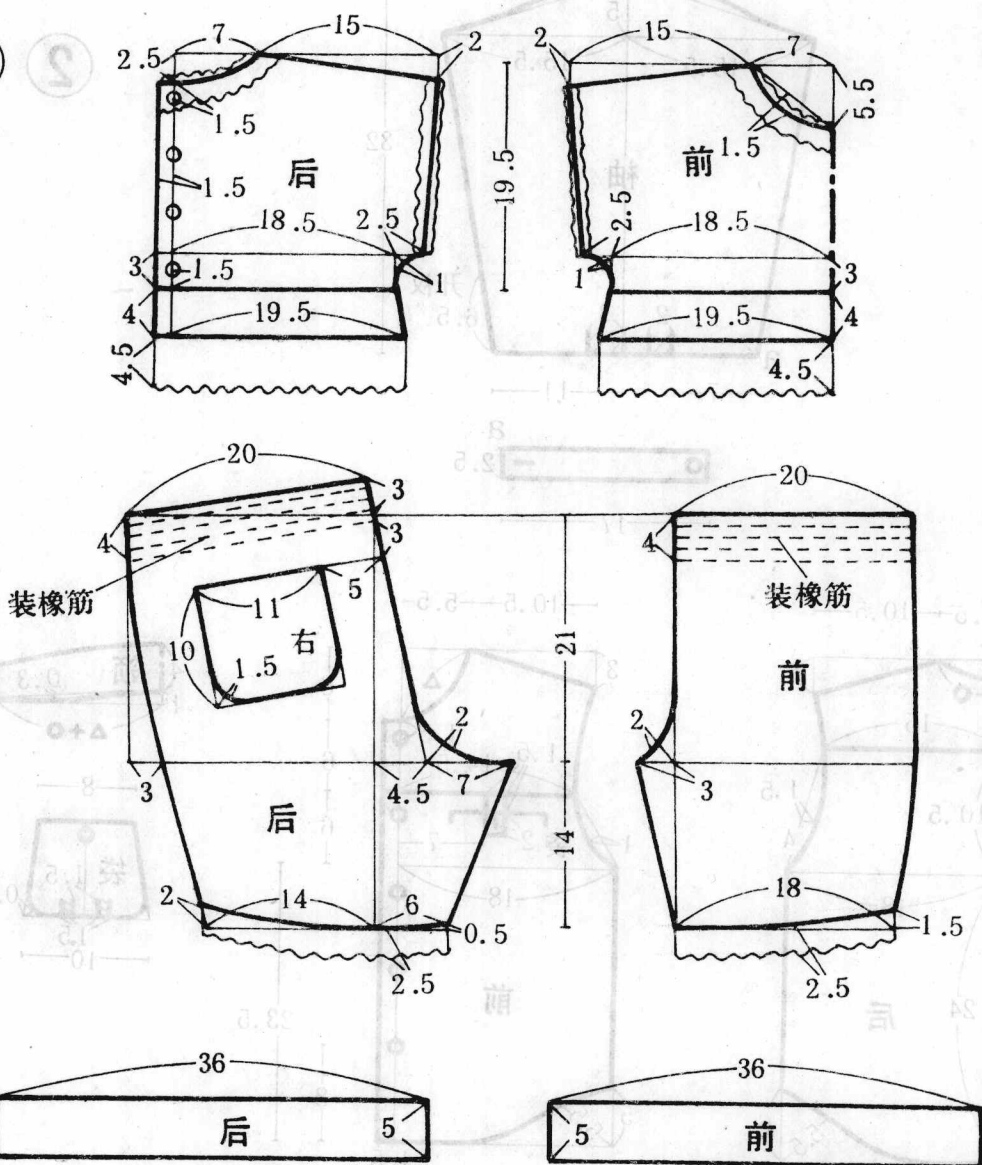

年龄：2~3岁

身高：88~95厘米

用料：110厘米(门幅90厘米)

缝纫要点：①领圈、袖笼、肩缝和下摆均缉0.8厘米双止口。  
②裤腰装橡筋可略宽。  
③裤后片右边装贴袋，“×”字型缉双止口0.8厘米。



4

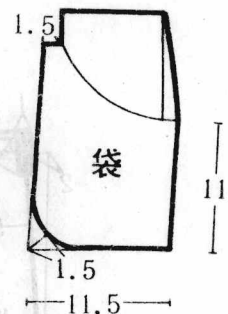
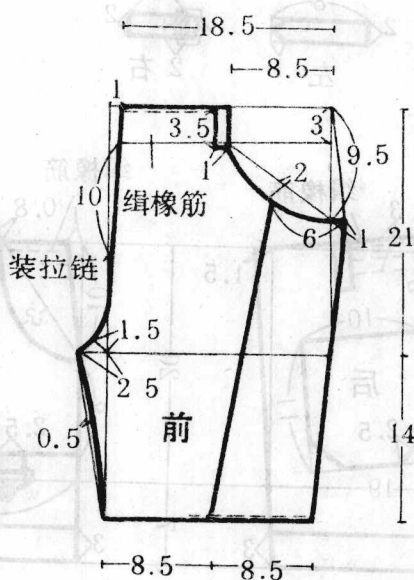
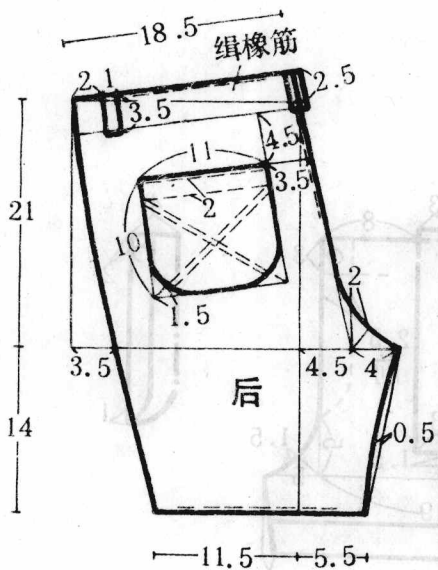
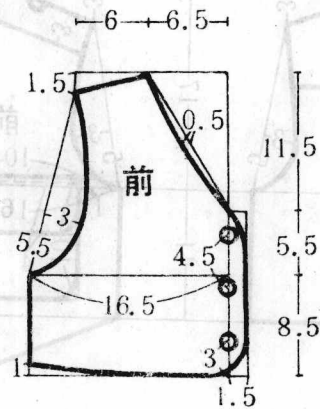
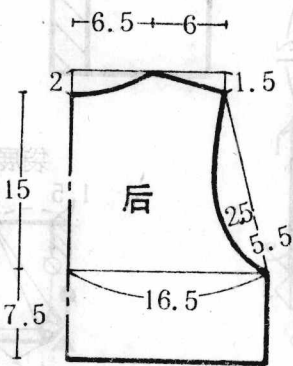



年龄：2~3岁

身高：90厘米

用料：140厘米(门幅90厘米)

- 缝纫要点：
- ①衣袋为立体式，缝纫时裱位制作做精确。
  - ②后片装饰祥和前裤袋装饰扣位置要正。
  - ③裤腰祥可作为装饰用。

5

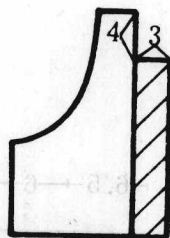
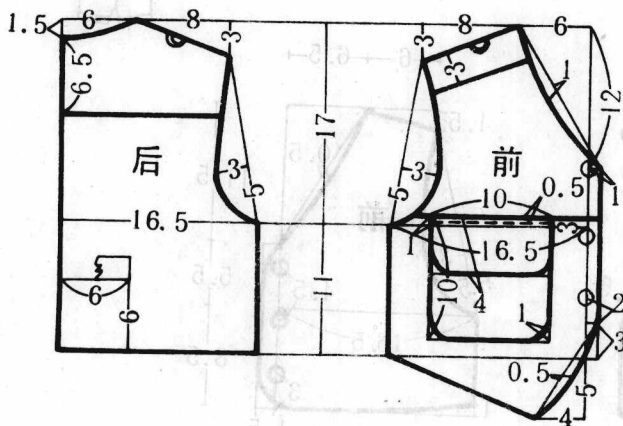

袋展开

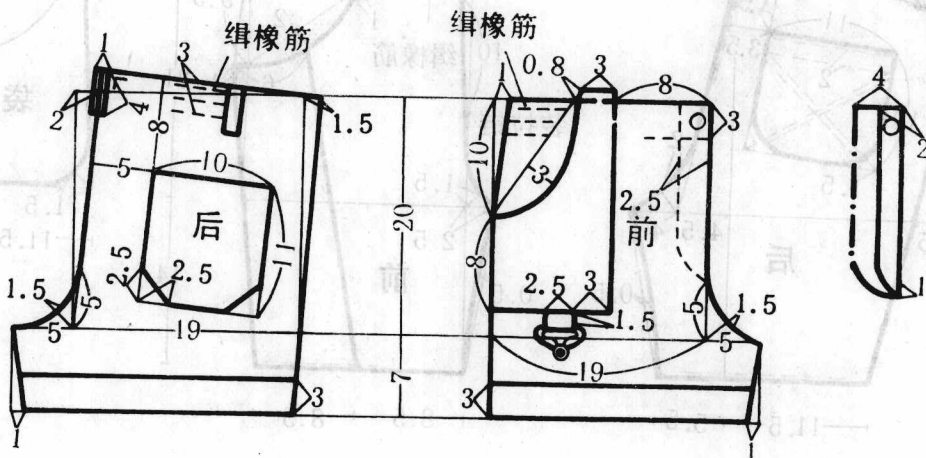
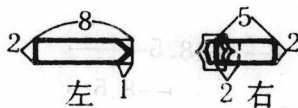
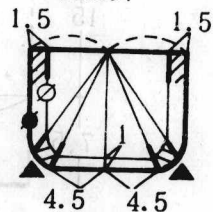

年龄：6~7岁

身高：115~120厘米

用料：A布51厘米（门幅110厘米），  
B布83厘米（门幅110厘米）。

制作顺序：上衣①锁边。

②做帽和串绳。

③装贴袋。

④缝合肩缝。

⑤装帽。

下裤①装门襟

②装后贴袋。

③缝合侧缝和裆缝。

④装缉裤腰。

缝纫要点：①做帽要注意贴边缝合宽窄的一致。

②贴袋缝线要直顺。

③门襟钉拷钮。

④帽和下摆均穿带，带两头要扎结。

⑤裤腰装橡筋，缉线要均匀。

⑥裤门襟装拉链，也可锁钮洞钉钮。

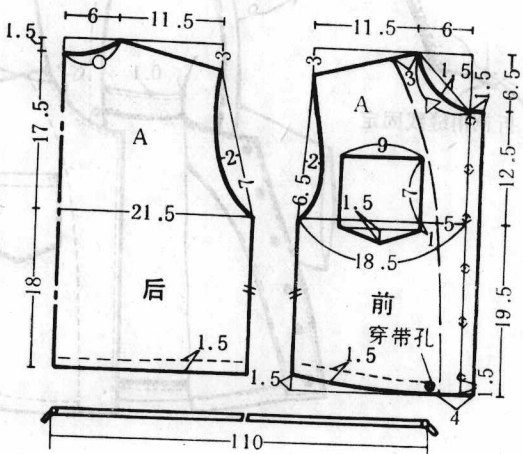
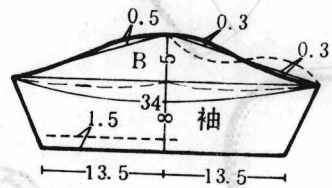
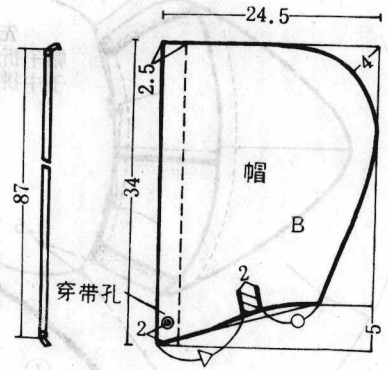

6

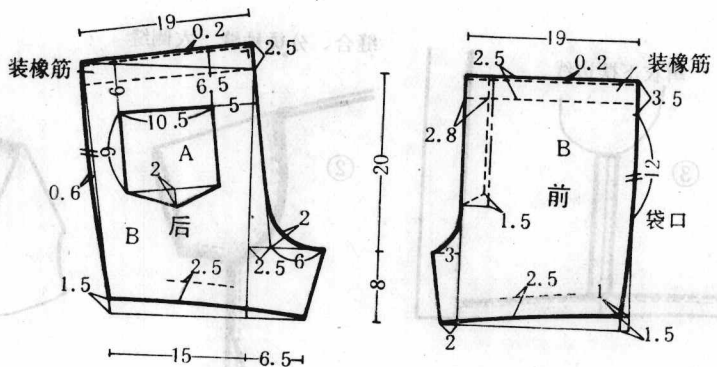
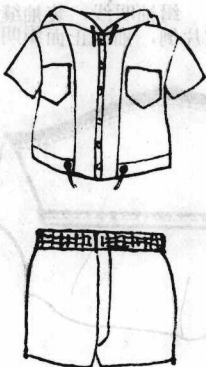

7

先将帽装在衣身上，  
帽子折袖与肩缝对齐，帽  
子中拼缝与后领中点对齐

将挂面与后领贴  
边沿原缝装上

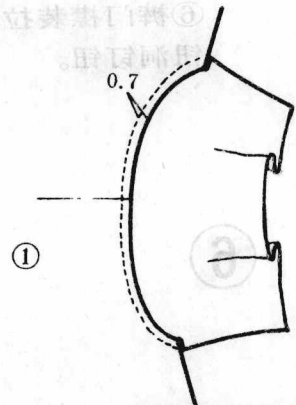
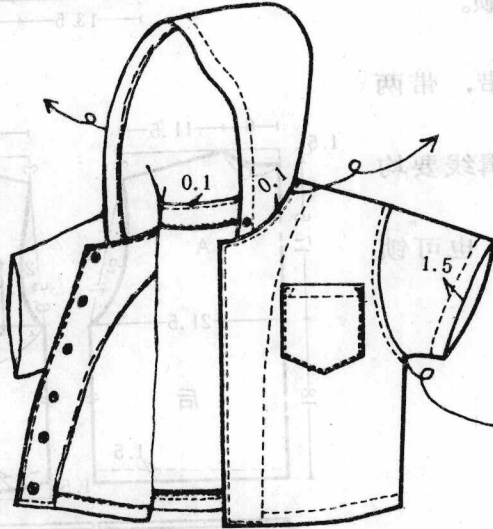
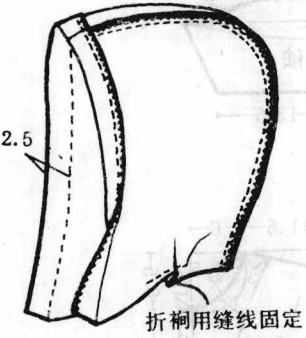
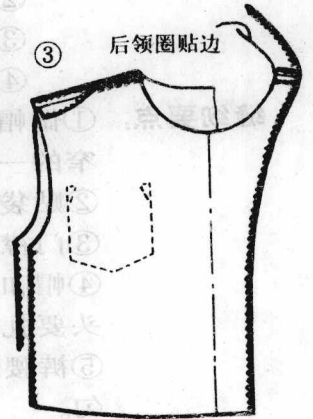
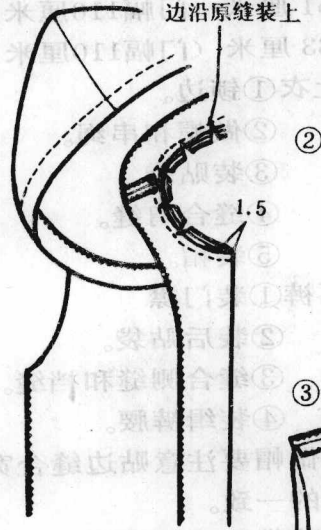
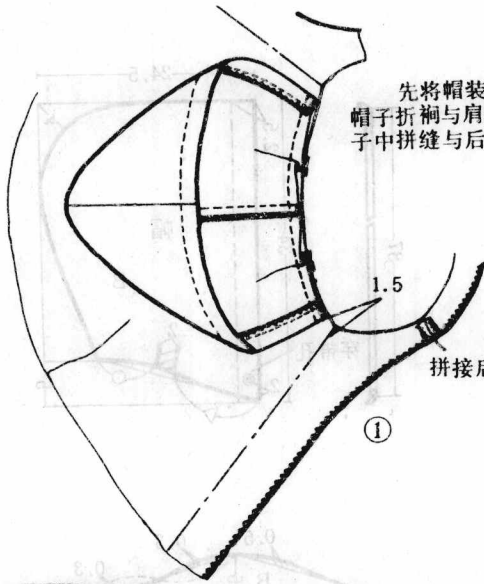

缉袖明线，装袖缝头朝  
衣片倒，袖笼正面缉明线

缝合、分烫袖缝、衣侧缝

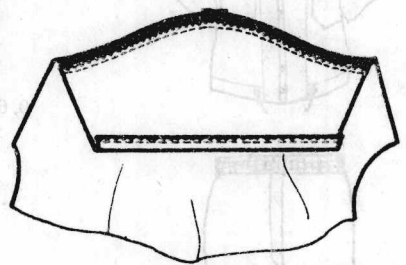
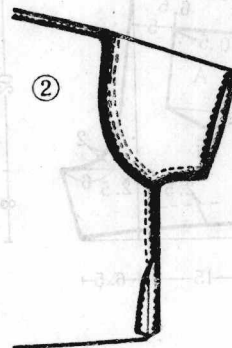
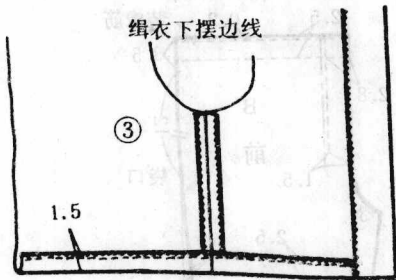



①

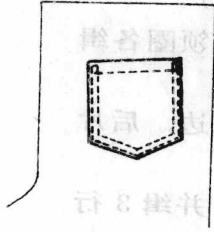
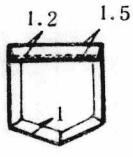

在袋口两角后面垫两小块料子，以增加袋口牢度

②

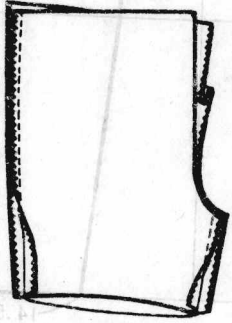
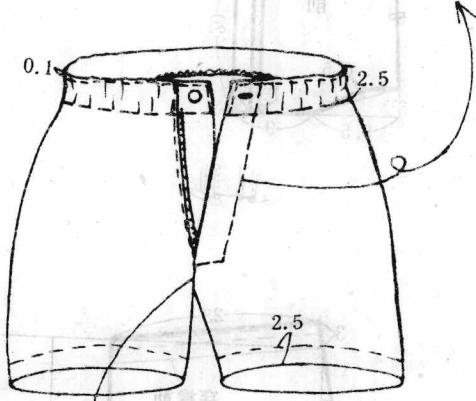
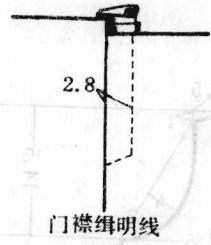
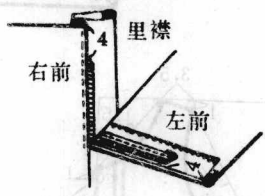
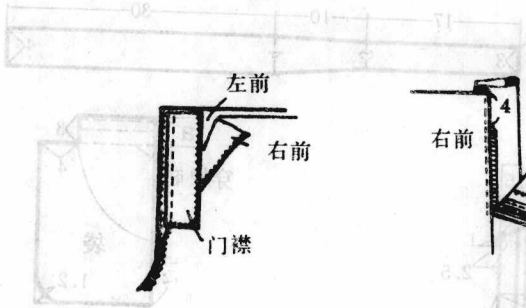

缝至7cm处回针，上面装门

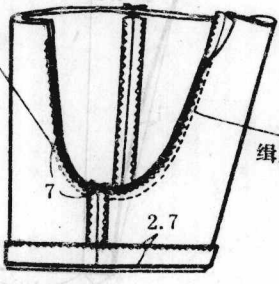

缝合后裆缝要缉双线，增加牢度

年龄: 6~7岁

身高: 110~115厘米

用料: 200厘米(门幅90厘米)

- 缝纫要点:
- ①袖笼、下摆、领圈各缉0.5厘米止口。
  - ②前片门襟嵌花边, 后片门襟钉钮。
  - ③裤腰装橡筋, 并缉3行明线。

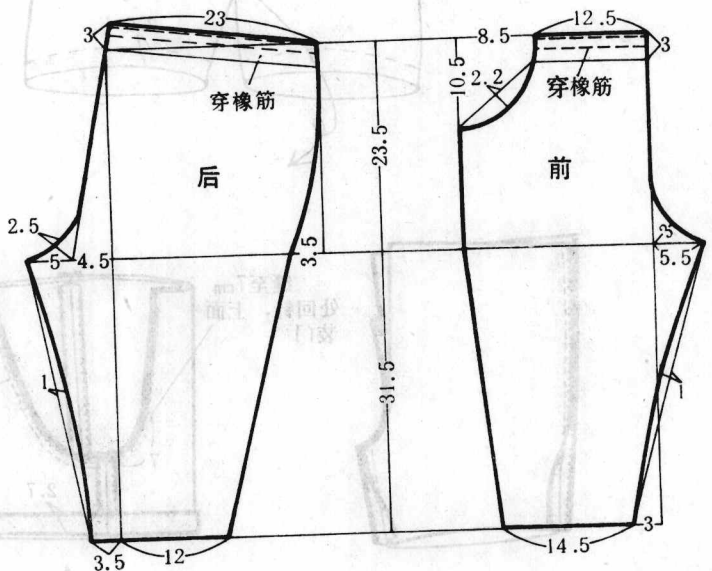
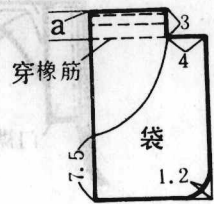
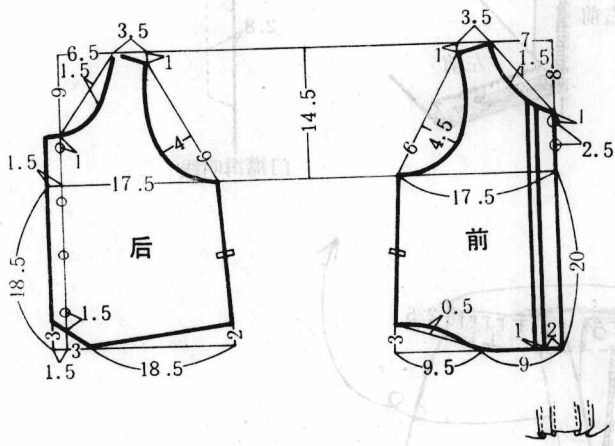
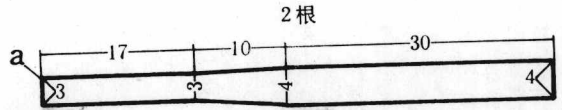

7

年龄：2岁前后

身高：90厘米

用料：90厘米(门幅150厘米)

- 缝纫要点：①插袋贴边可略大。  
②腰部拼接需注意缉线的平直。  
③脚口抽衲要均匀。

8

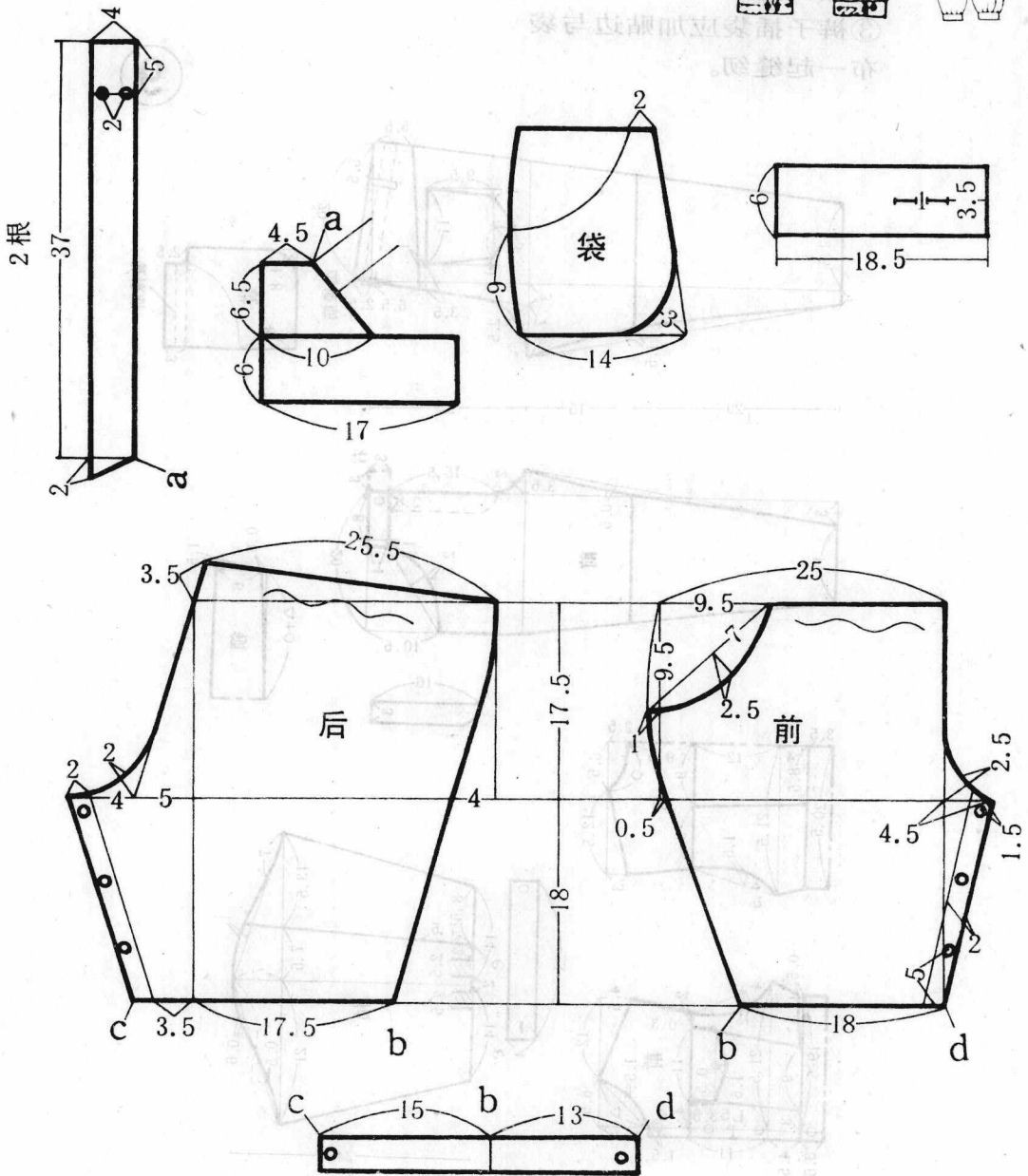
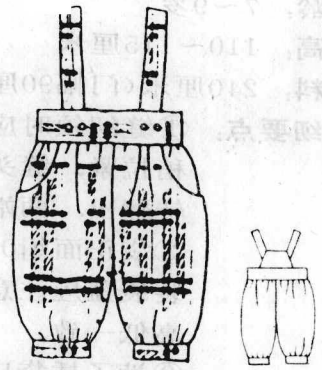

年龄：7~9岁

身高：110~115厘米

用料：240厘米(门幅90厘米)

- 缝纫要点：
- ① 缝纫领时应将领里两角稍拉紧，缝头修整齐，折转翻出，两端角烫平服。
  - ② 袋正面缉0.1厘米止口，装袋盖应注意左右对称及高低一致。
  - ③ 裤子插袋应加贴边与袋布一起缝纫。

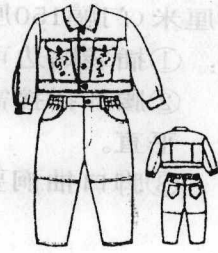

9

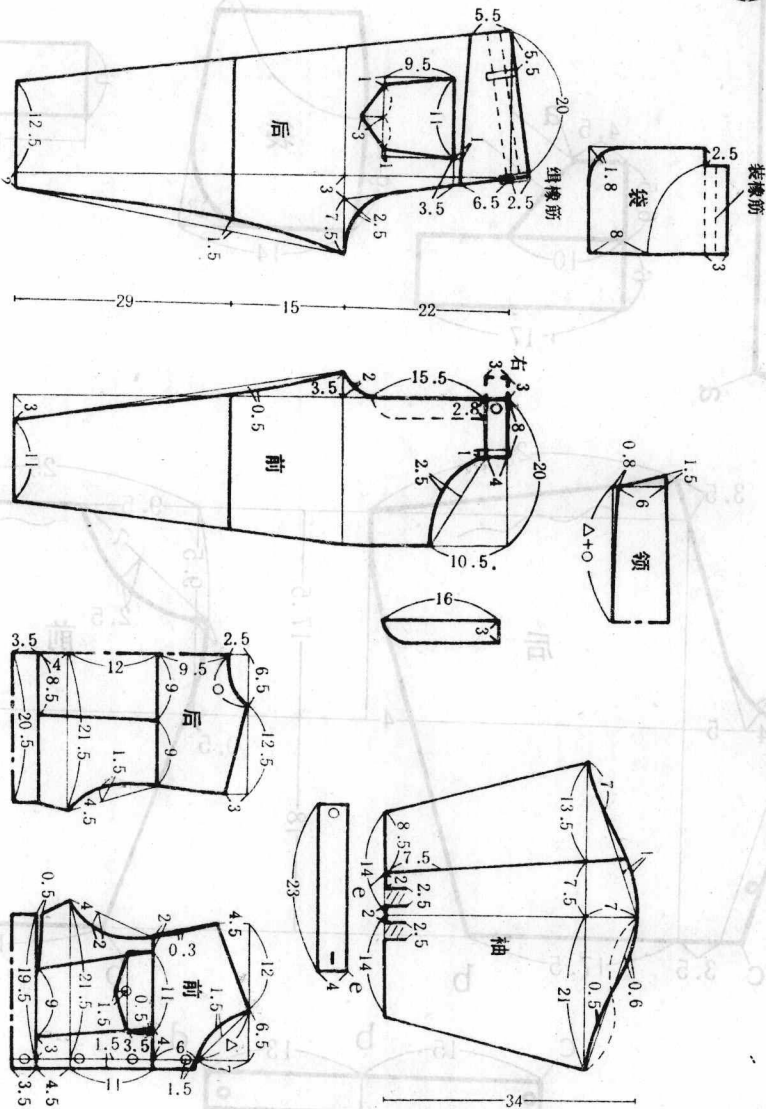

年龄:

身高: 103~110厘米

用料: A布60厘米(门幅90厘米)

B布110厘米(门幅90厘米)

C布20厘米(门幅90厘米)

D布20厘米(门幅90厘米)

缝纫要点: ①注意各块布的不同裁剪尺寸和图案纹样的选用。

②缉线可用1色。

10

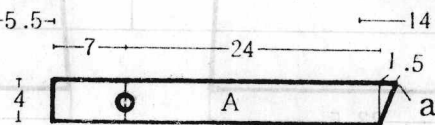
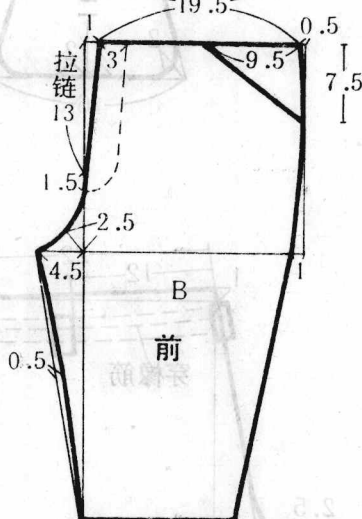
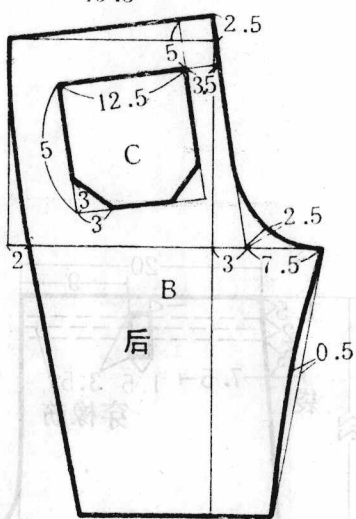
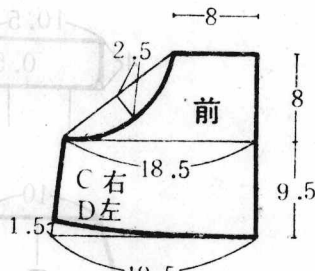
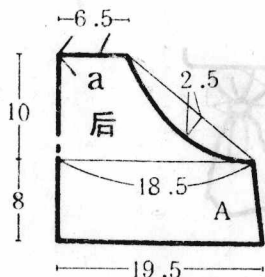
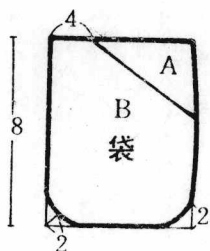

2根



年龄：3~4岁

身高：96~103厘米

用料：80厘米(门幅90厘米)

缝纫要点：①袋位装饰布可插入袋盖夹层钉牢。  
②裤腰装橡筋，缉明线，后装裤祥。



11

