

## 前 言

如今,我国的经济发展已经取得了很高的成就,人类文明进入了新的阶段。随着人类文明的进步,人们对生活质量和生活环境越来越讲究,家居空间的装饰装修可以营造出优美的环境,让紧张工作之余的您在家中得到身心的放松和内心的平静。

本书是一本实用性很强的设计图库,收录了家庭装修室内设计施工图纸19套,其中家装单层户型方案13套,家装复式户型设计6套。每套图纸在光盘中都有一一对应的DWG文件和主要的效果图以及3D模型。不但可以激发设计者的设计创意,还可以对应方案名称直接调取使用,大大缩短了设计师的设计成图时间,减轻设计师的工作负担,有效地提高设计图纸的绘制效率和质量,极大地提高了工作效率,极具参考价值和使用价值,适合于室内设计人员和相关专业人员使用。

书中附赠室内设计中绘制施工图时500多个常用的设计素材和设计图块,包括门窗图形、装饰图案、家具设施、饰画饰品、室内植物以及人物图块等等价值相当高的设计素材,方便读者在设计时直接使用。

本书适合各个阶层的家装设计师使用,由于编写经验和个人学识有限,书中难免有疏漏之处,欢迎读者批评指正。

编者

# 目 录

## 前言

### 家装单层

方案1 .....	1
方案2 .....	11
方案3 .....	23
方案4 .....	35
方案5 .....	43
方案6 .....	57
方案7 .....	65
方案8 .....	77
方案9 .....	87
方案10 .....	95
方案11 .....	107
方案12 .....	119
方案13 .....	131

### 家装复式

方案14 .....	141
方案15 .....	161
方案16 .....	169
方案17 .....	185
方案18 .....	197
方案19 .....	207

### 家装图块

门图块 .....	220
中式门图块 .....	223
装饰图案 .....	224
壁炉图块 .....	225
装饰画图块 .....	227
装饰品图块 .....	229
窗帘图块 .....	232
桌椅图块 .....	236
家具图块 .....	237
植物图块 .....	238
立面树图块 .....	241
室内植物图块 .....	244
人物图块 .....	246

效果图欣赏 .....	247
-------------	-----

《精品家装设计图库》

# 家装单层



方案 1

■ 方案1

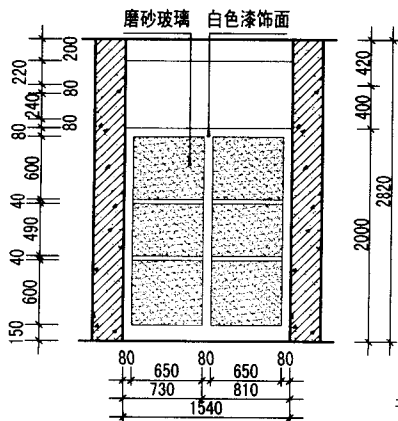
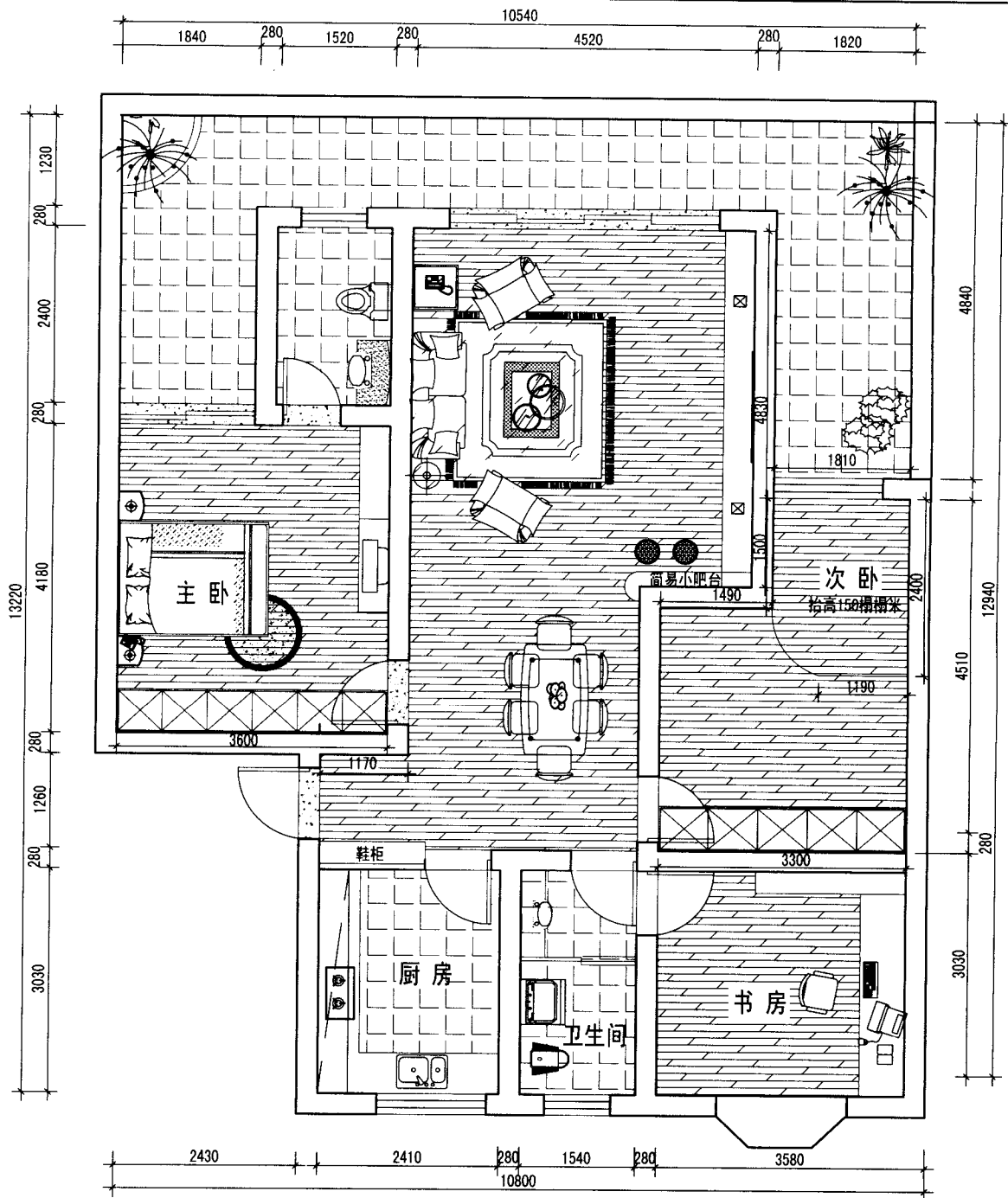

卫生间玻璃横拉门立面图

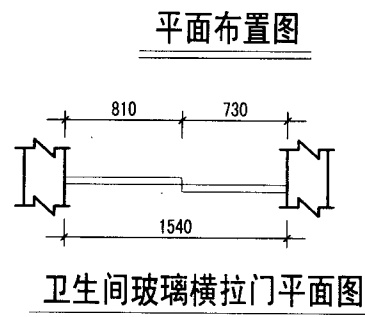

卫生间玻璃横拉门平面图

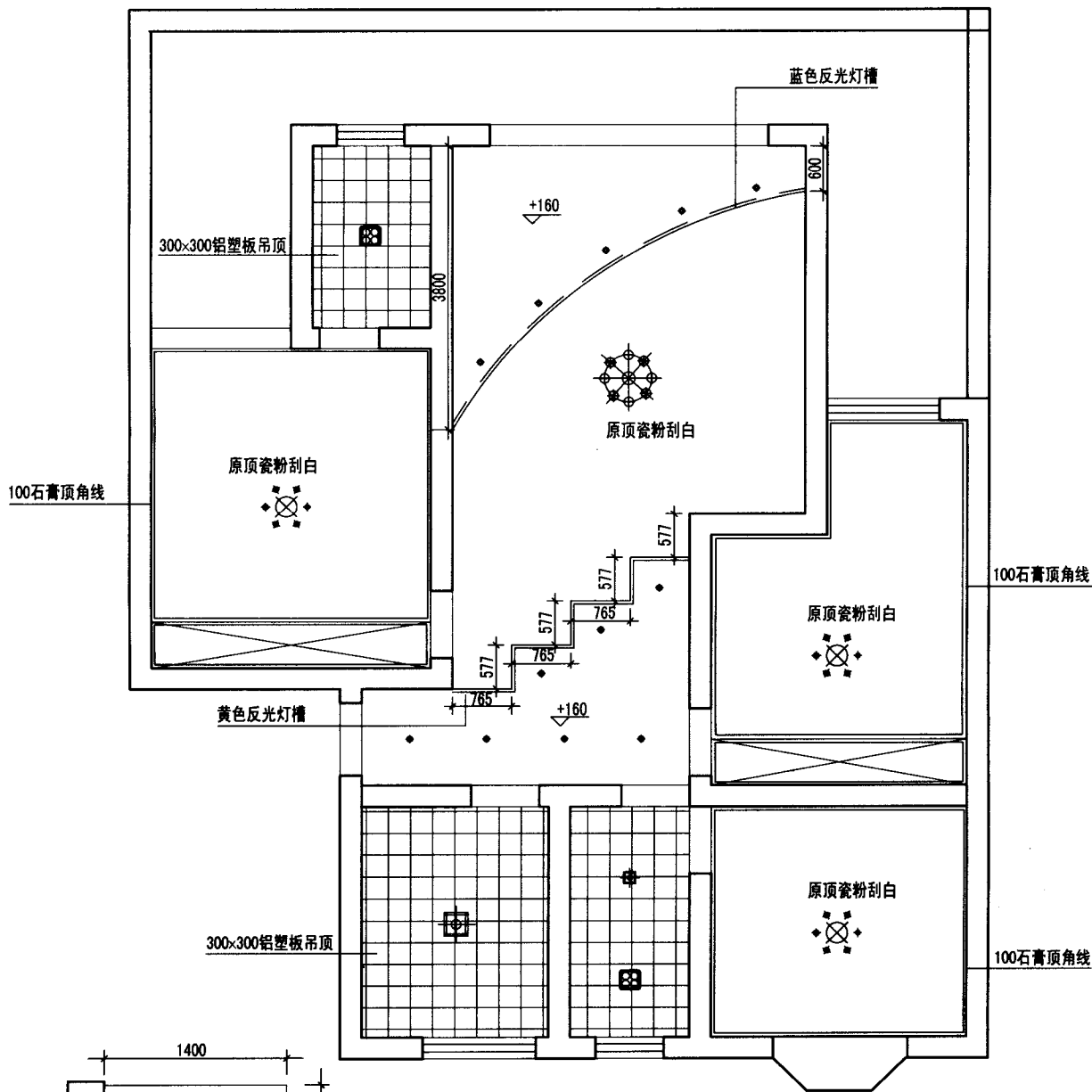

顶面布置图

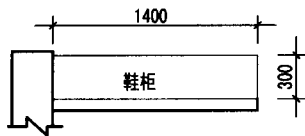

鞋柜平面图

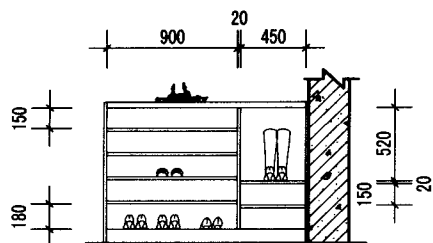

鞋柜结构图

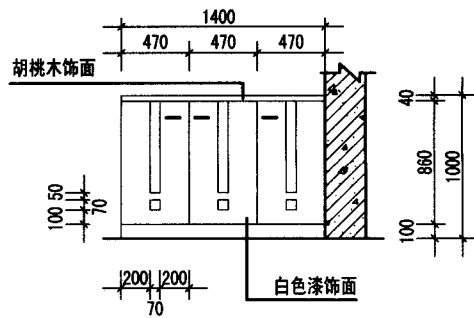

鞋柜立面图



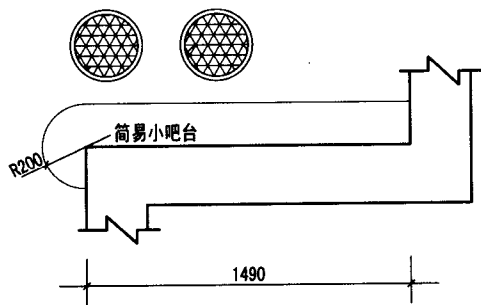

客厅吧台及墙面装饰平面图

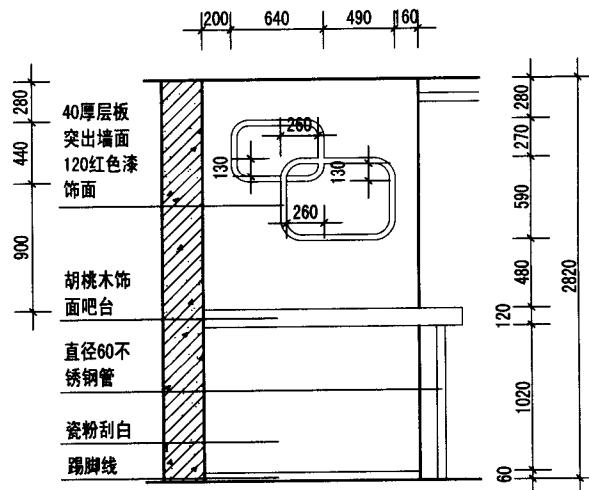

客厅吧台及墙面装饰立面图

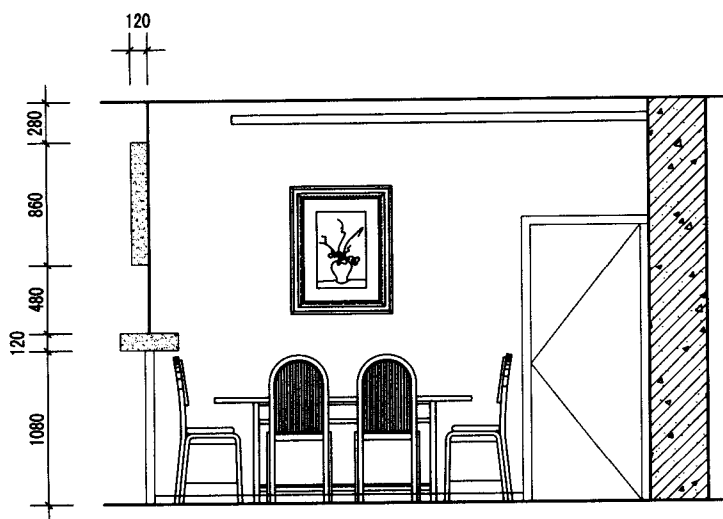

客厅吧台及墙面装饰侧视图

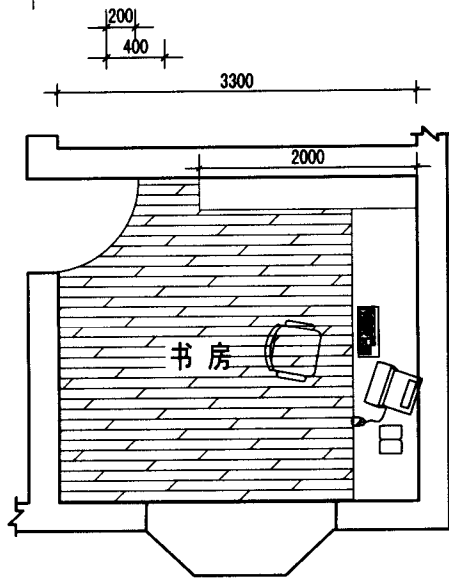

书房书柜平面图

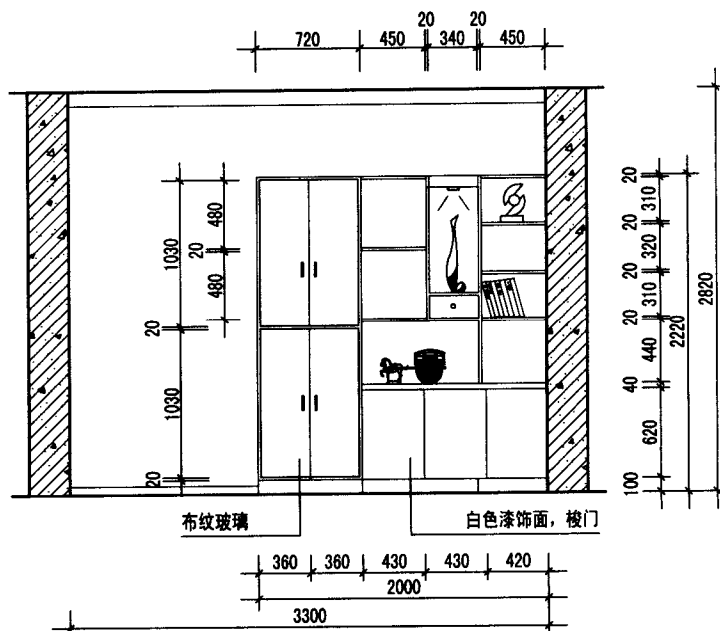

书房书柜立面图

■ 方案1

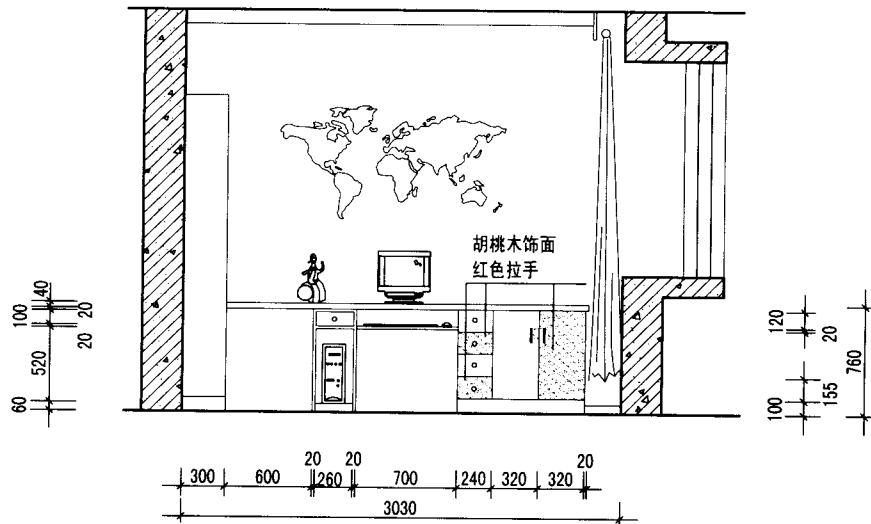

书房电脑桌立面图

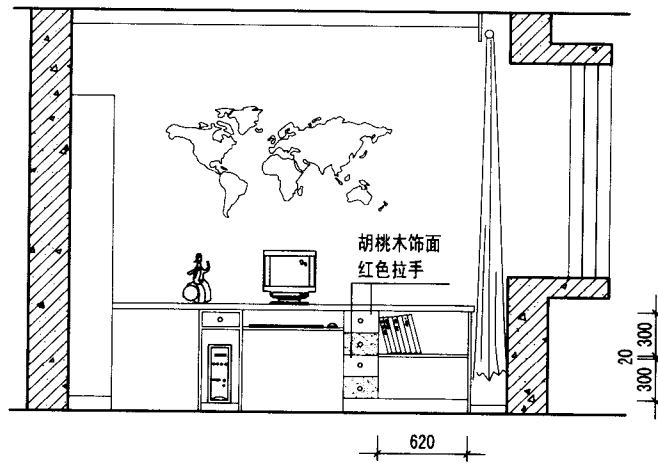

书房电脑桌结构图

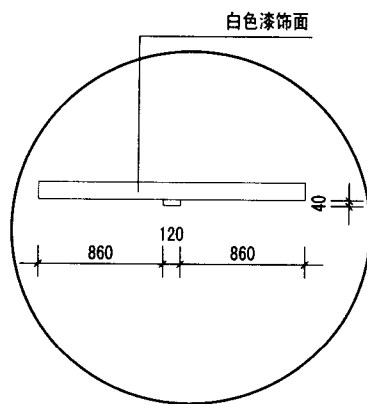

门平面图

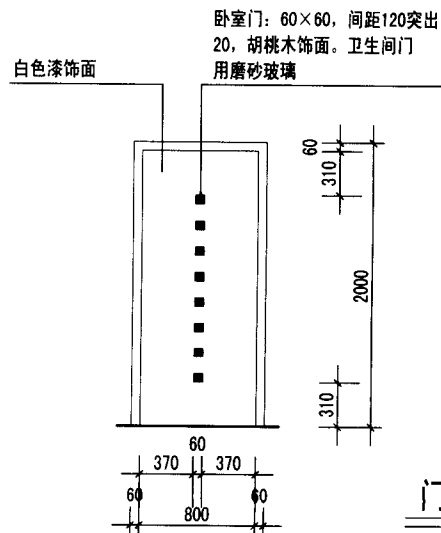

门立面图



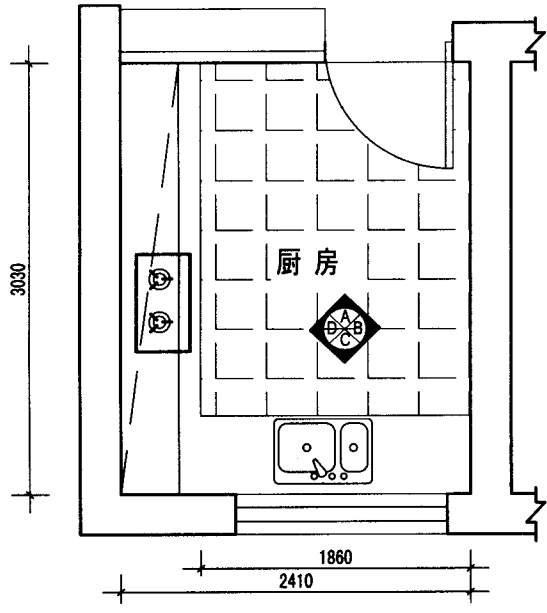

厨房平面图

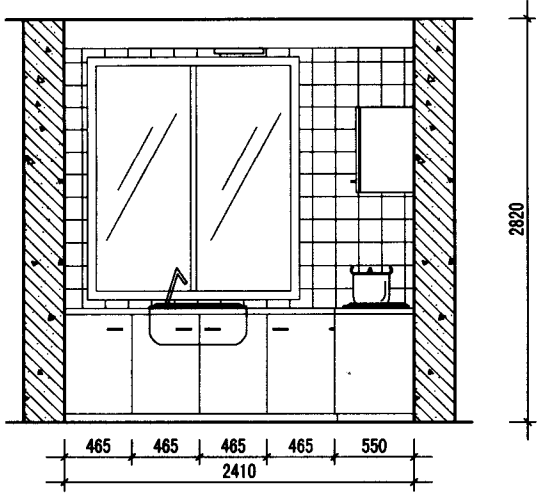

厨柜C立面图

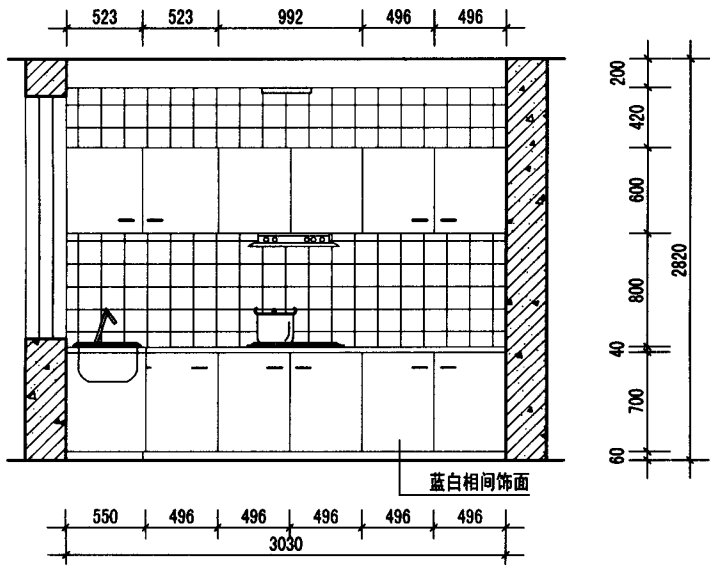

厨柜D立面图

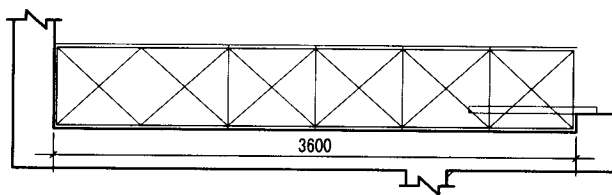

主卧衣柜平面图

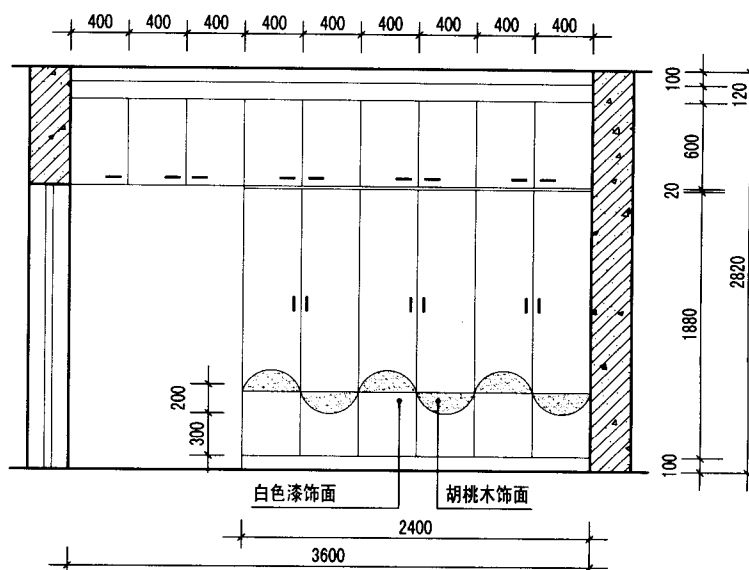

主卧衣柜立面图

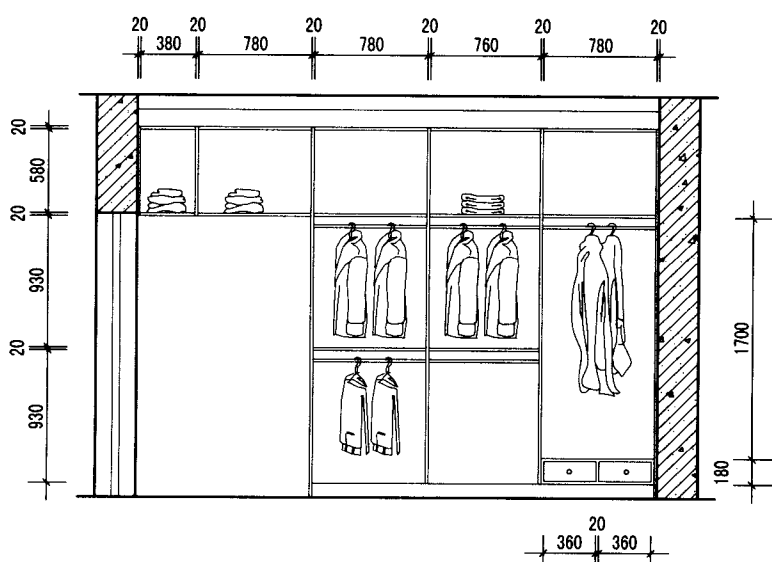

主卧衣柜结构图

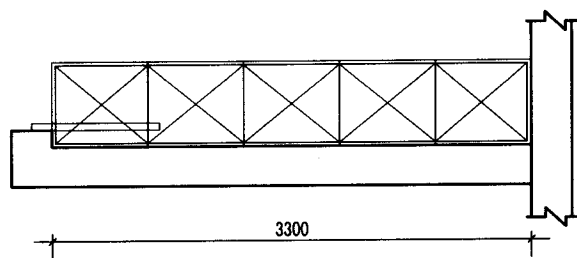

次卧衣柜平面图

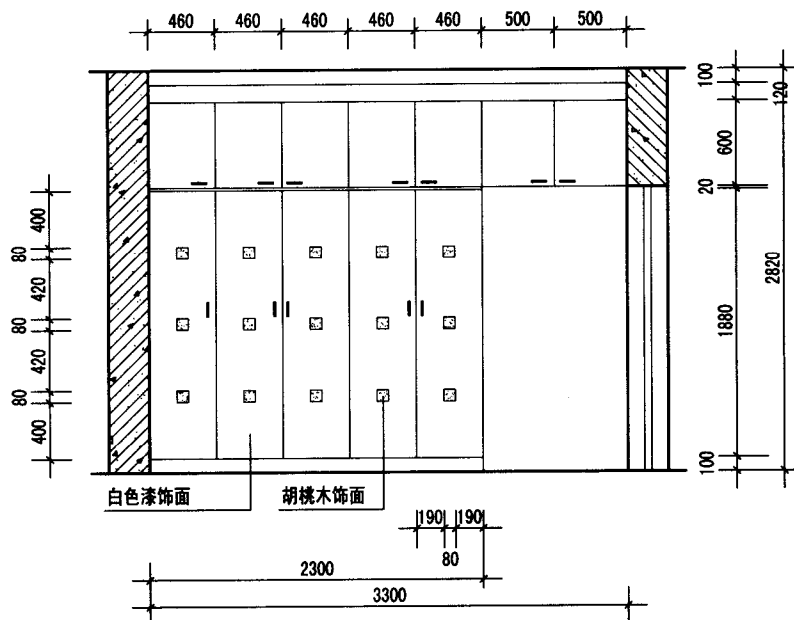

次卧衣柜立面图

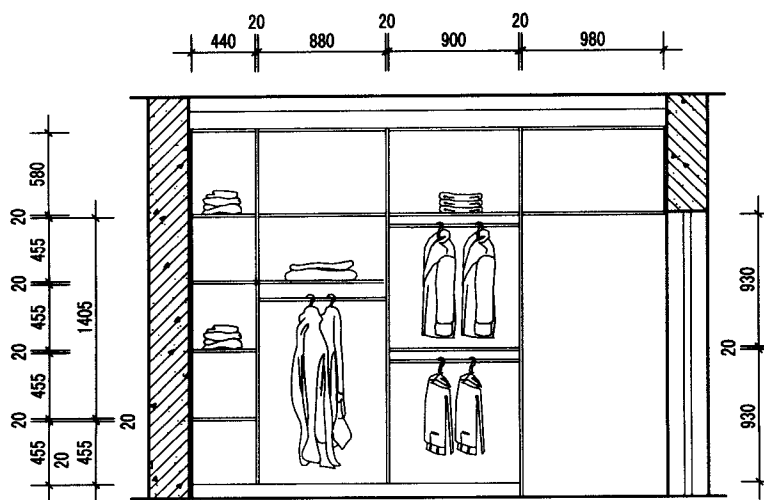

次卧衣柜结构图



《精品家装设计图库》

# 家装单层



方案 2

# 方案2

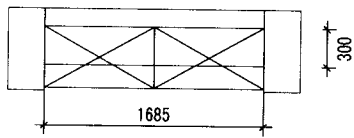
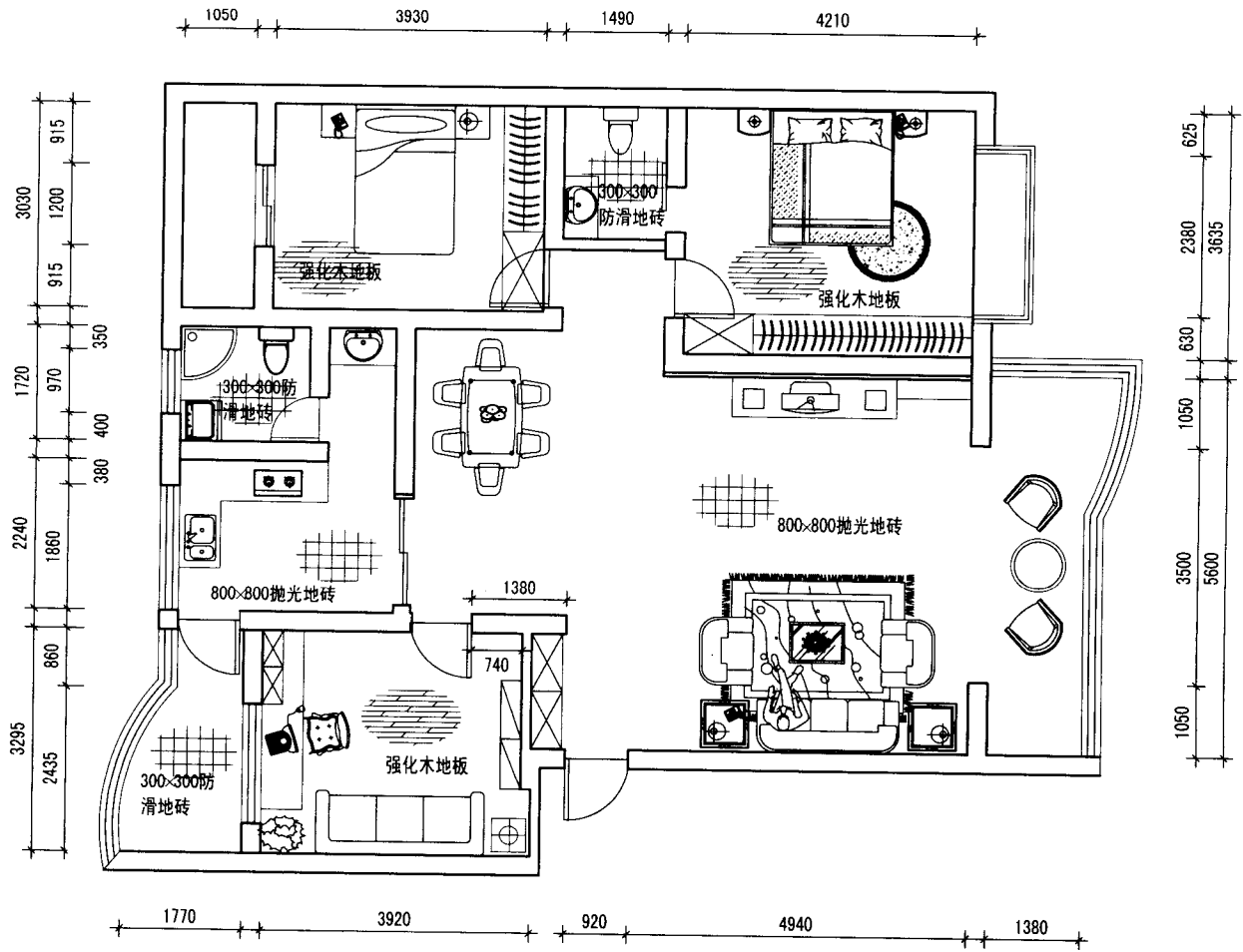

鞋柜平面图

平面布置图

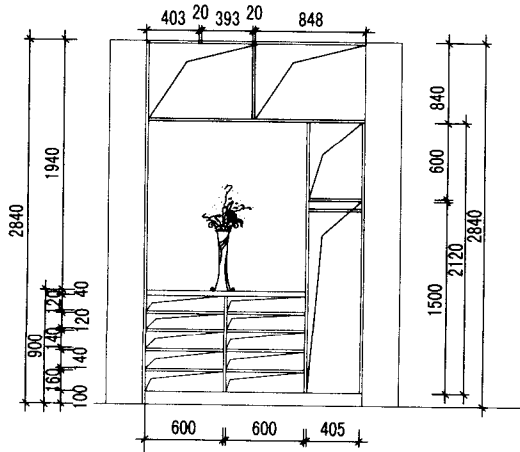

鞋柜结构图

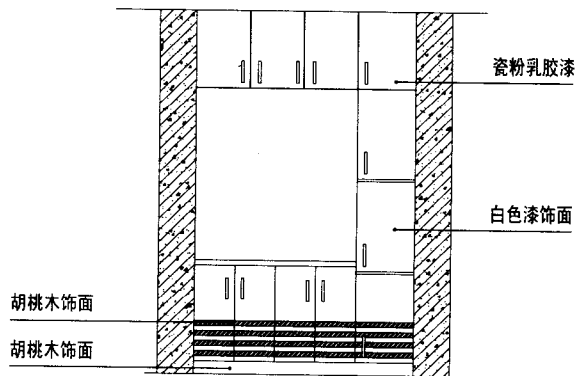

鞋柜立面图



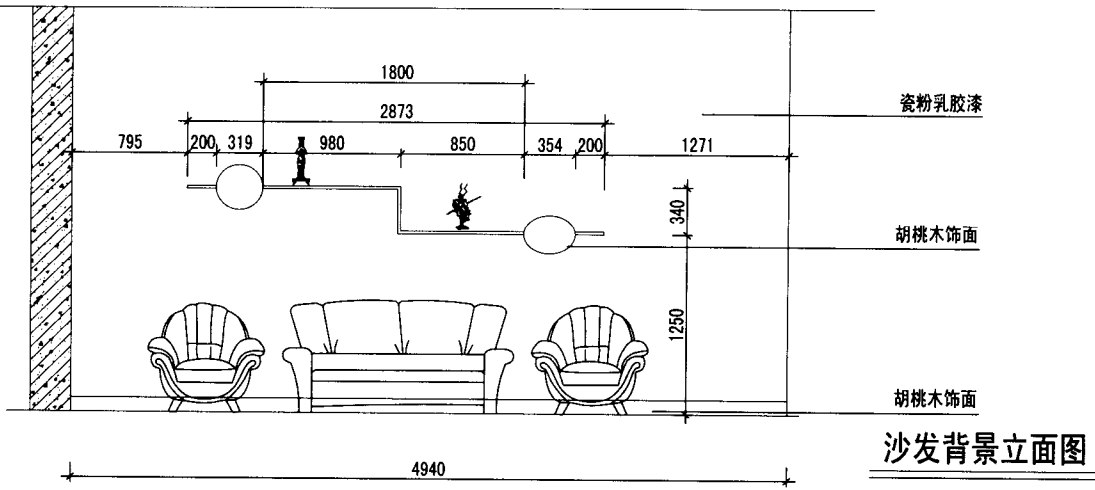

沙发背景平面图

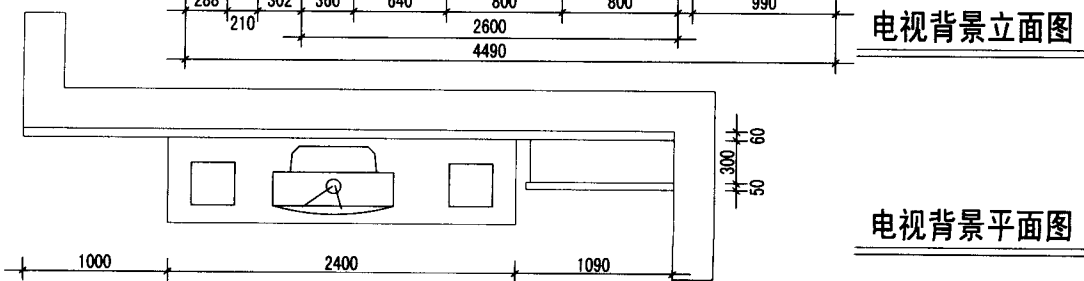
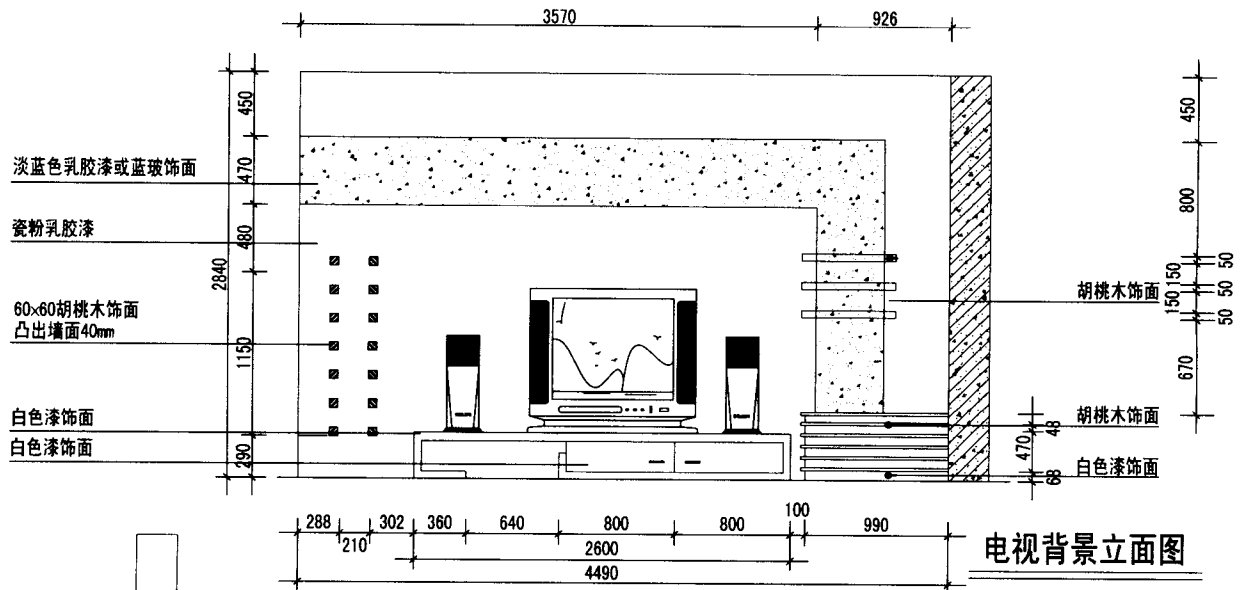
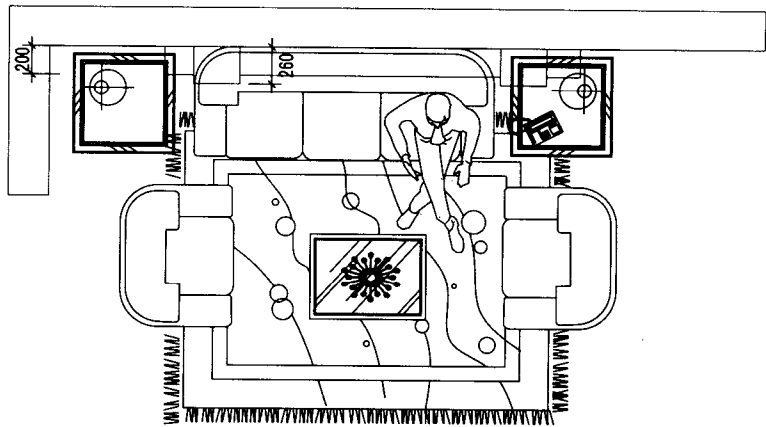



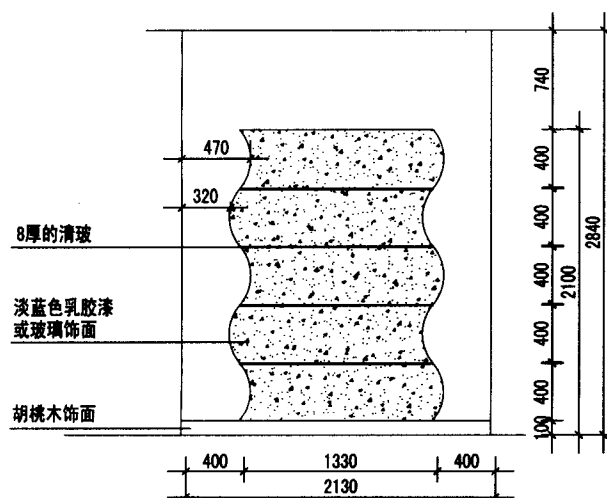
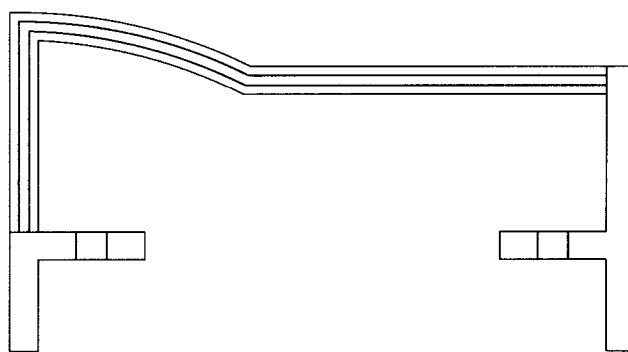
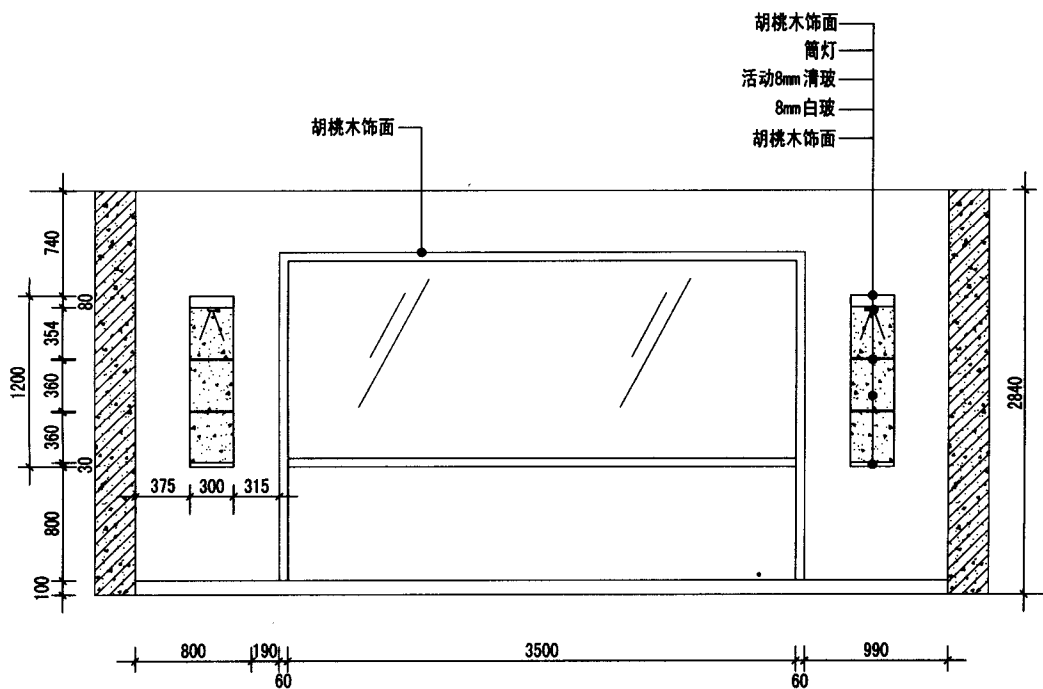

餐厅背景立面图

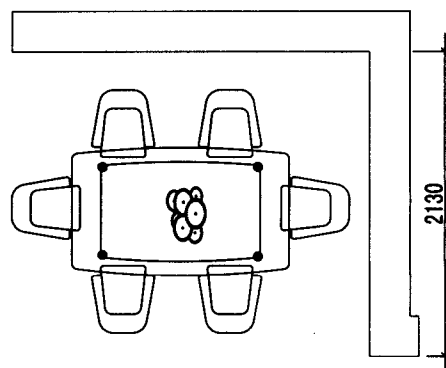

餐厅平面图