

彭福涵 徐錦華  
合 編

# 机械制图基础

(附說明書)

科学技術出版社

# 机械制图基础

彭福涵 徐锦华 合编

科学技术出版社

## 內 容 提 要

本書包括機械制圖最重要的基礎部分——應用幾何、正投影、副投影和剖面圖。全部採用立體圖解方式，由淺入深有系統地介紹了投影的原理和制圖的方法。全書共162頁，計650余圖，分為說明、示范和習題三類。另有文字說明一冊，對照書中圖畫逐一加以簡明介紹。

## 機 械 制 圖 基 礎

(附說明書)

合編者 彭福海 徐錦華

\*

科學技術出版社出版

(上海建國西路326弄1號)

上海市書刊出版業營業證出079號

京華印刷廠印刷 新華書店上海發行所總經售

\*

統一書號：15119·324

(原新華版印2,000冊)

開本：787×1092 1/16·印張：10 3/8·圖650幅

1956年12月初1版

1957年5月第2次印刷·印數2,001—6,500

定價：(10) 1.70元

## 序

隨着大建設的開展，機器製造工業有着飛躍的進步。各種新式機器不斷地從各工廠中生產出來。這些機器，從設計開始，直到製造裝配完成，中間經過非常複雜而細緻的過程；在這些過程中，機械圖紙始終起着重要的作用。尤其在今後大規模的社會主義性質的機器生產中，規格要求嚴格，從設計起，就要求技術人員具有熟練的製圖知識，而在製造過程中，同樣要求技術工人必須會看任何複雜的圖樣，並根據圖紙上規定的規格進行工作，否則，大規模的生產就完全不可能。解放前，我國工業落後，工廠中對圖紙的要求遠非今日可比，所以有些老年技工，雖有着豐富的技术經驗，但對圖紙的繪製和理解卻有着一定程度的困難。青工和藝徒們自然更感到掌握機械製圖知識的迫切。因此可以這樣講，在現代化工廠中的職工如果不懂機械圖，則一切工作都將無法進行。

但是在初學機械製圖時，確會遇到一些困難，主要因為立體實物和平面圖形間的相互關係，一時不易在頭腦中建立起來。因此，為了適應目前工礦企業廣大職工學習機械製圖的需要起見，我們編著了這樣一本書，採用立體圖投影箱和平面視圖相對照的方式來說明投影原理，以培養這種想像能力，使初學者達到充分理解製圖的基本理論。

根據編者過去的經驗，讀圖是一般初學者所最感到困難的，推究其原因，還是在於少練習，想像力差的緣故。因此，本書中列舉了許多示範性的例題和習題，另附文字說明一冊，以便讀者能利用它進行學習。

因為篇幅的限制，本書內容祇包括機械製圖基礎部分中最重要的一部分。關於尺寸註寫、習慣畫法、工作圖等部分，我們準備另行處理。

本書的編繪與一般機械製圖書籍不同，雖然費時較久，然不妥之處在所難免，希望愛護本書的讀者給予批評和指正。

編者

一九五五年八月十日

# 目 次

	本書 頁數	說明書 頁數
第一章 應用幾何 圖 1-1 至圖 1-28·····	1	1
第二章 投影 圖 2-1 至圖 2-10·····	28	9
第三章 正投影 圖 3-1 至圖 3-44·····	30	12
第四章 正投影示範及習題 圖 4-1 至圖 4-221·····	53	18
第五章 副投影 圖 5-1 至圖 5-30·····	123	20
第六章 剖面圖 圖 6-1 至圖 6-33·····	144	23

# 圖1-1 二等分一已知直線或圓弧



圖1-2 通過已知一點作定直線的平行線

圖1-2-甲1



圖1-2-乙1

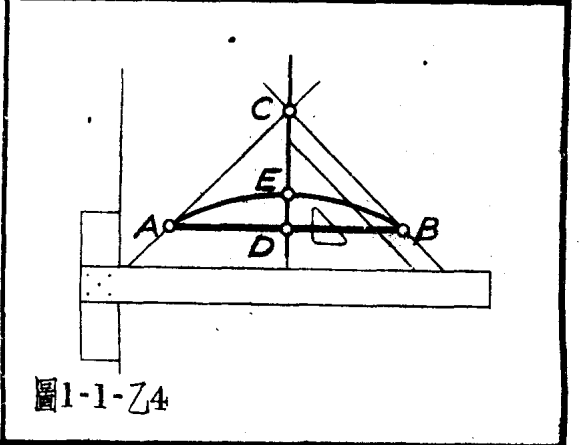
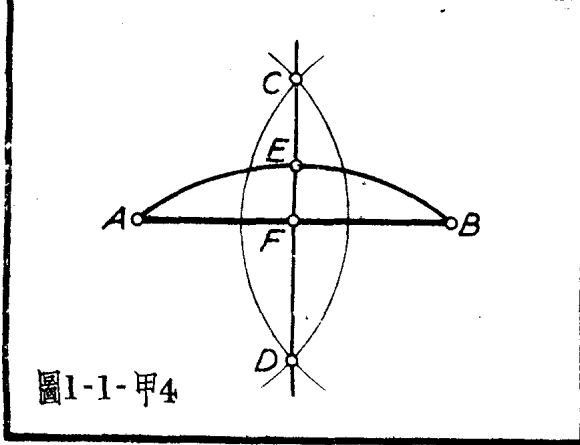
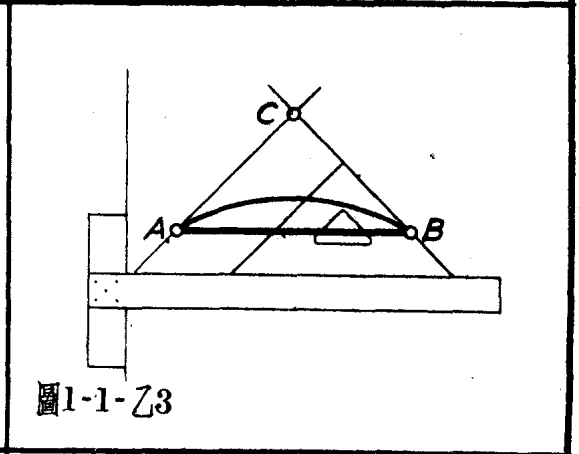
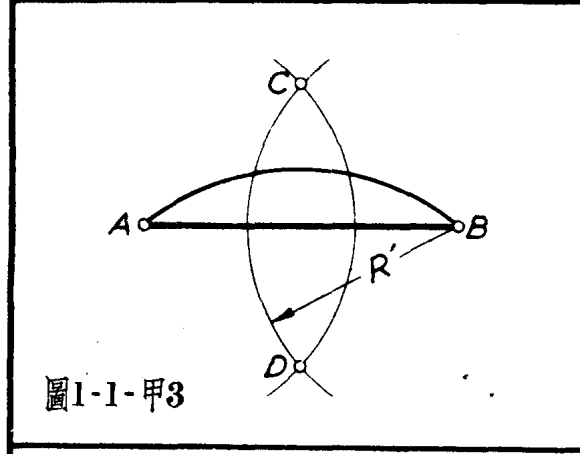
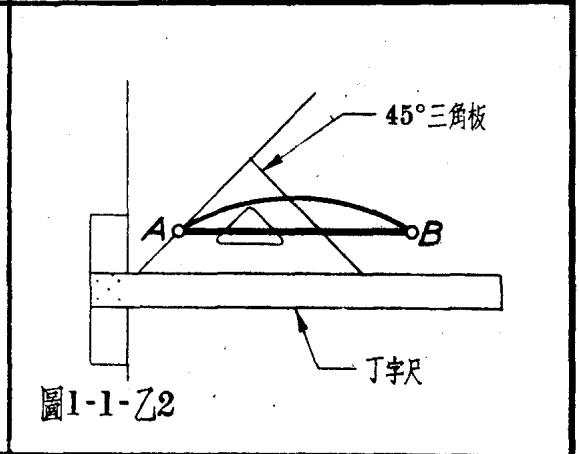
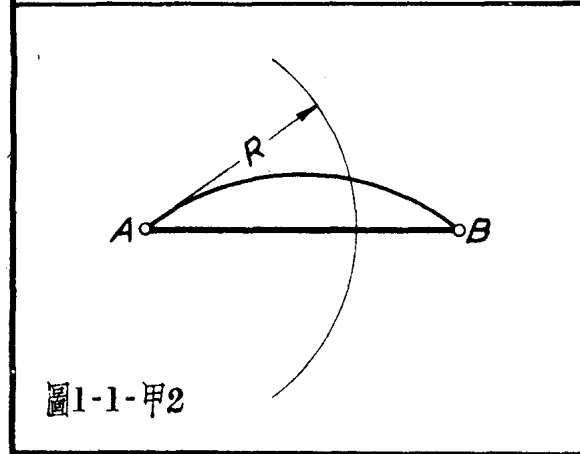
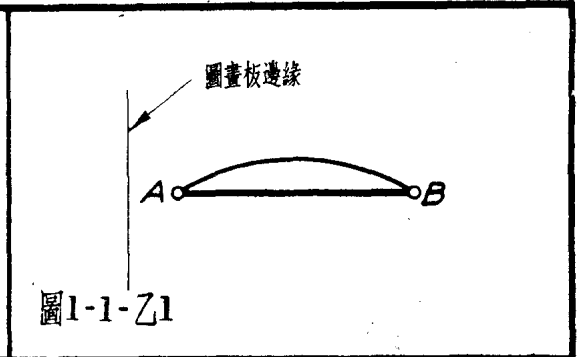
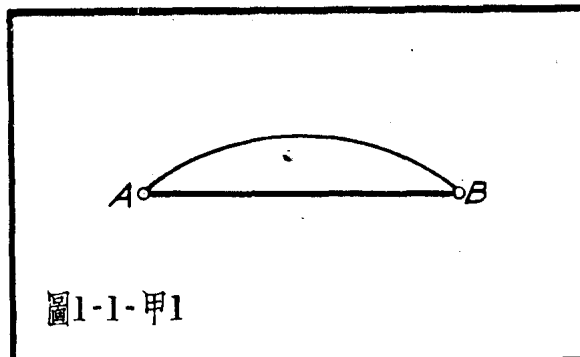

圖1-2-甲2

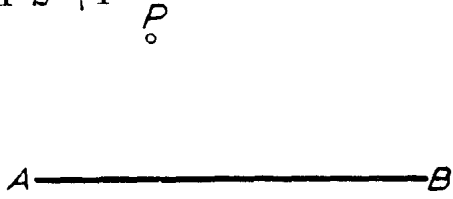

圖1-2-乙2

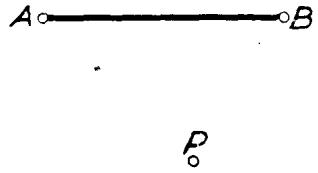

圖1-2-甲3

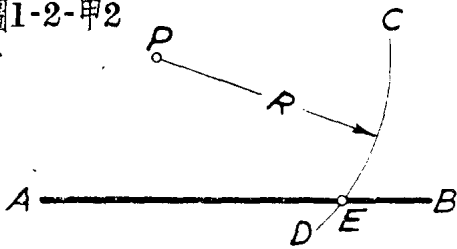

圖1-2-乙3

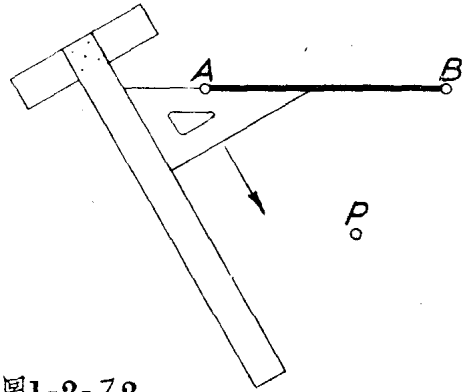

圖1-2-甲4

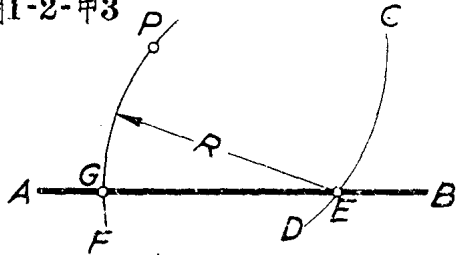

圖1-2-乙4

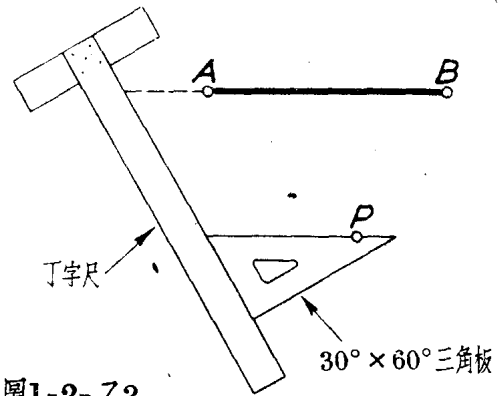

圖1-2-甲5

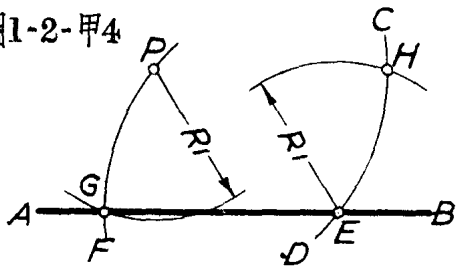

圖1-3 作距離一直線為定距的平行線

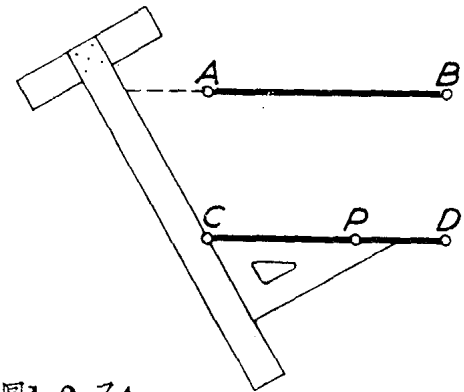

圖1-3-甲1

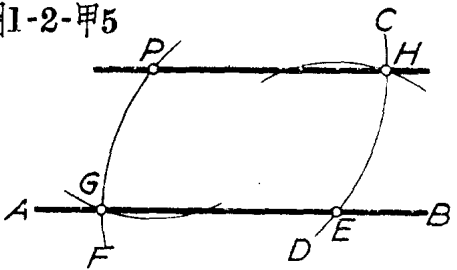

圖1-3-乙1

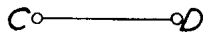

圖1-3-甲2

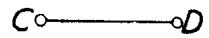

圖1-3-乙2

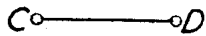

圖1-3-甲3

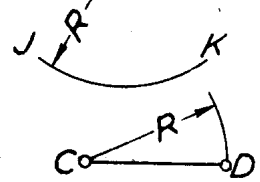
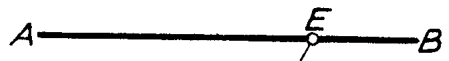

圖1-3-乙3

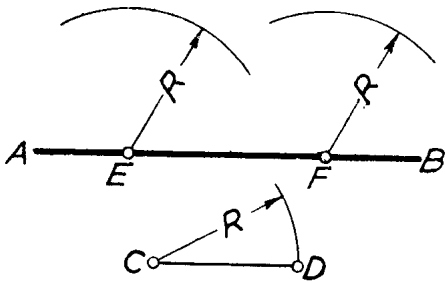

圖1-3-甲4

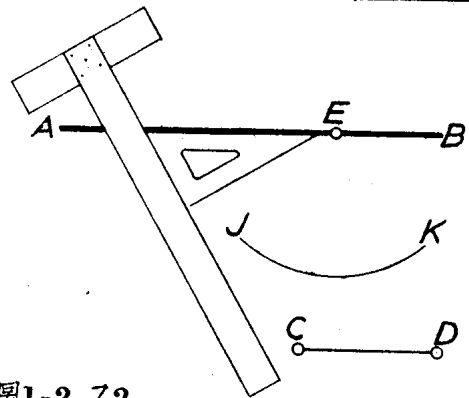

圖1-3-乙4

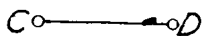
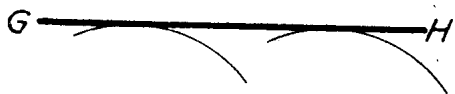

圖1-4 任意等分一直線

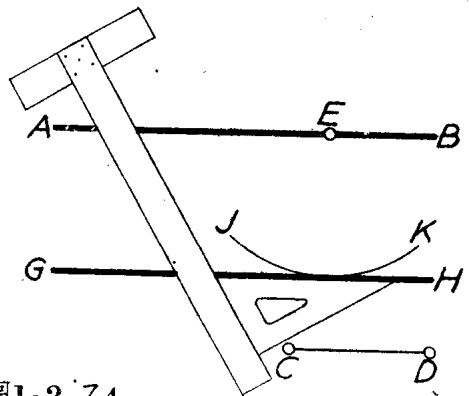

圖1-4-乙1



圖1-4-乙2

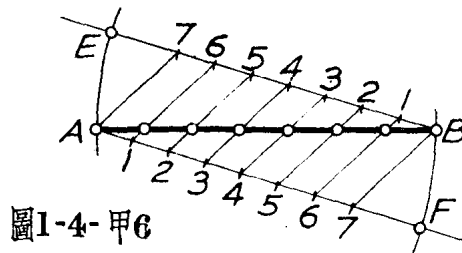
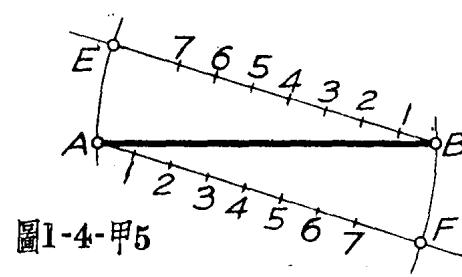
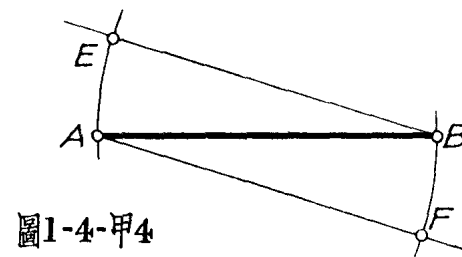
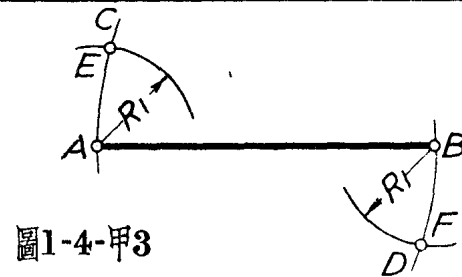
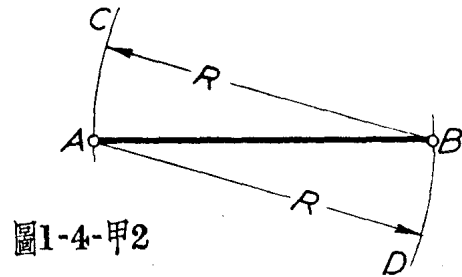
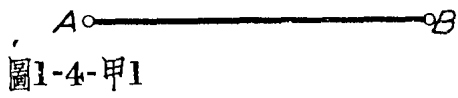

圖1-4-乙3



圖1-4-乙4

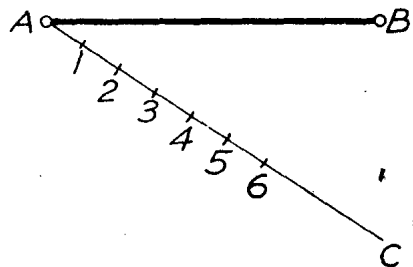

圖1-5 分割一直線為數段,使成一定比例

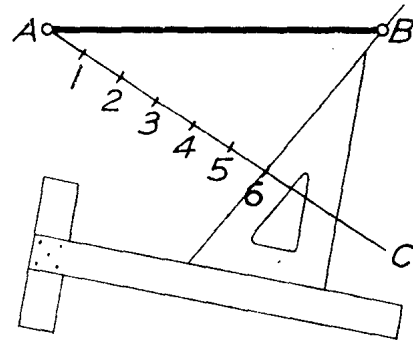

 <p>圖1-5-甲1</p>	<p>圖1-5-乙1</p> 	<p>圖1-5-丙1</p> 
 <p>圖1-5-甲2</p>	<p>圖1-5-乙2</p> 	<p>圖1-5-丙2</p> 
 <p>圖1-5-甲3</p>	<p>圖1-5-乙3</p> 	<p>圖1-5-丙3</p> 
 <p>圖1-5-甲4</p>	<p>圖1-5-乙4</p> 	<p>圖1-5-丙4</p> 

圖1-6 通過一定點作一直線的垂線(之一)

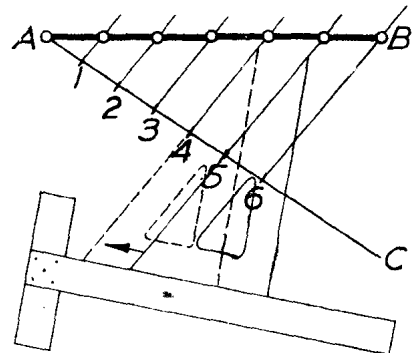

圖 1-6 通過一定點作一直線的垂線(之二)

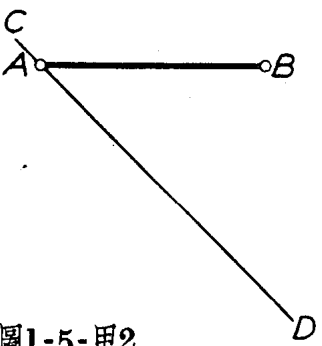
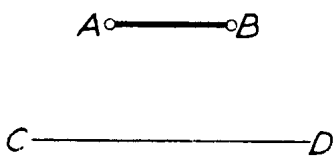
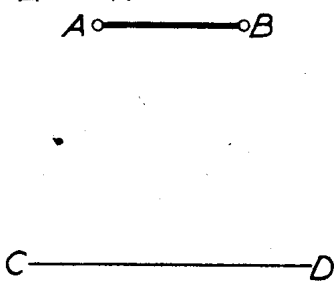
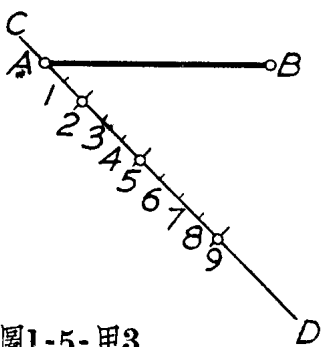
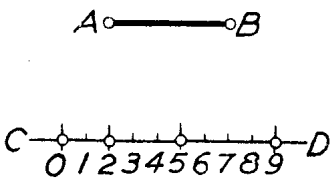
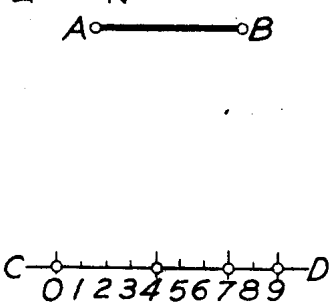
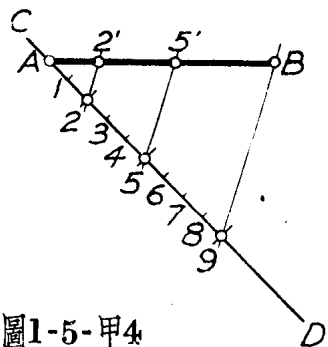
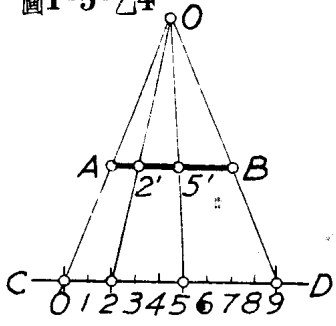
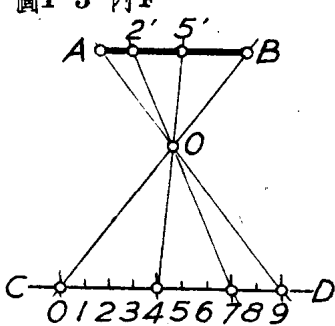

圖1-7 二等分任意角

圖1-8 三角形的作法

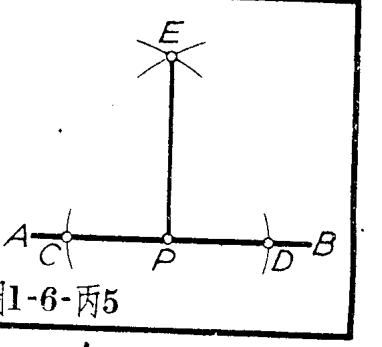
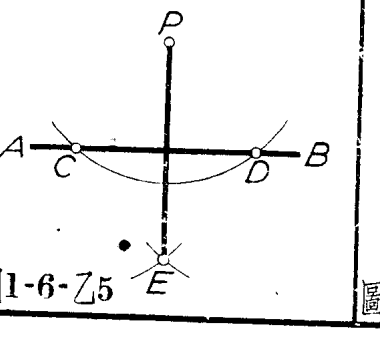
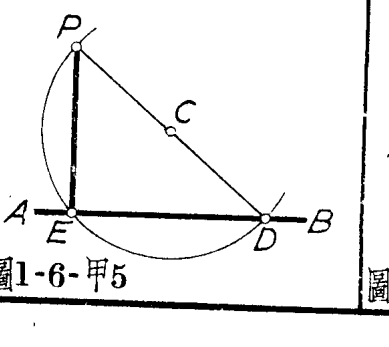
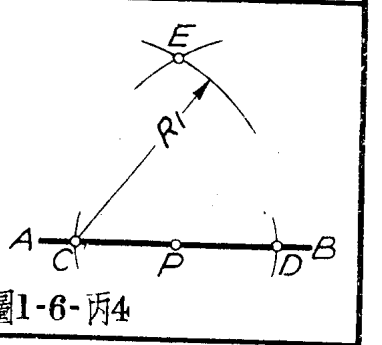
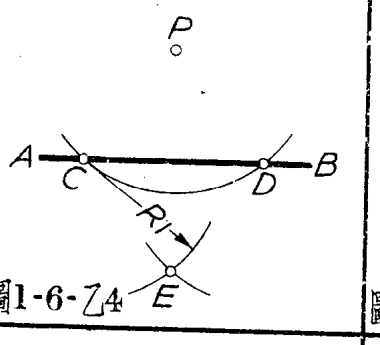
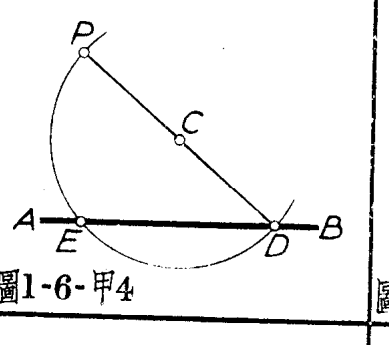
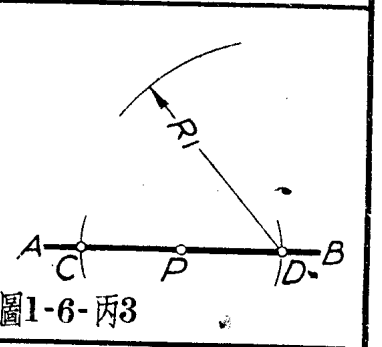
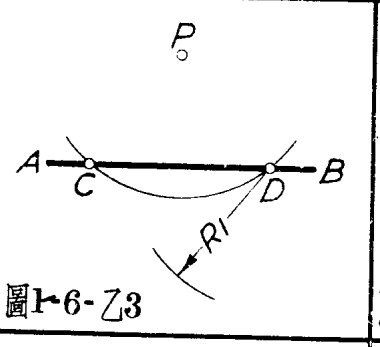
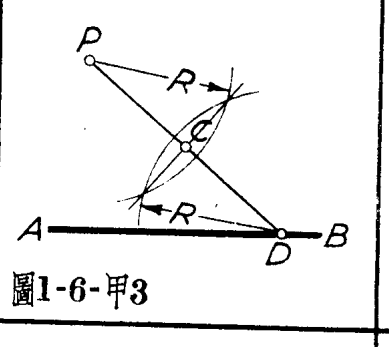
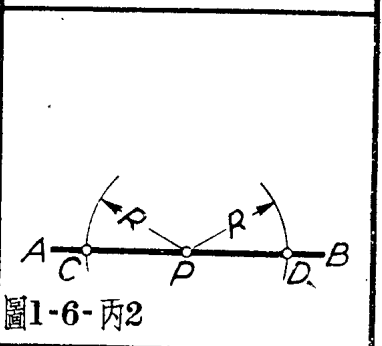
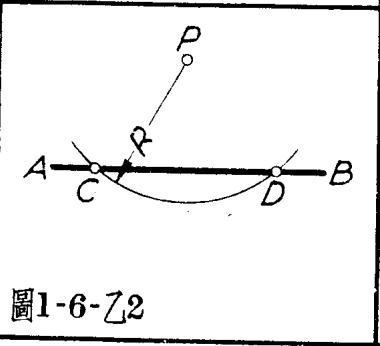
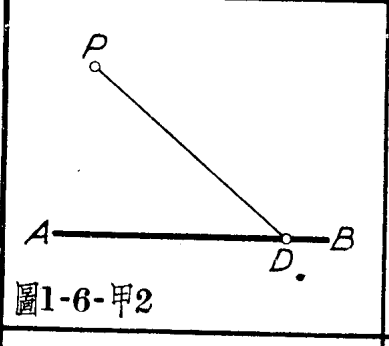
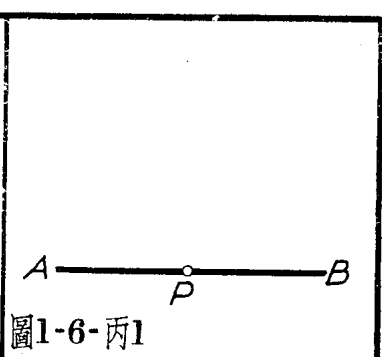
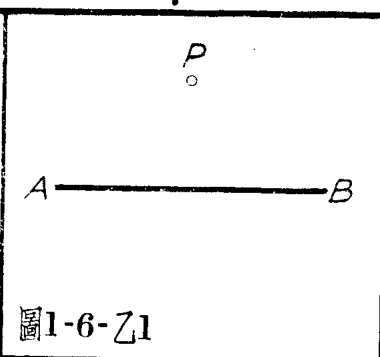
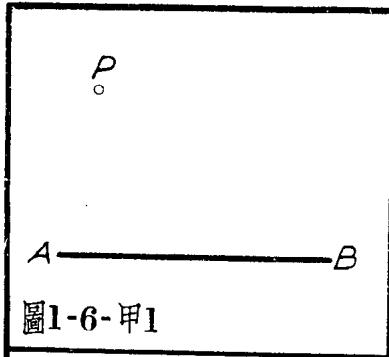

圖 1-9 等邊三角形的作法

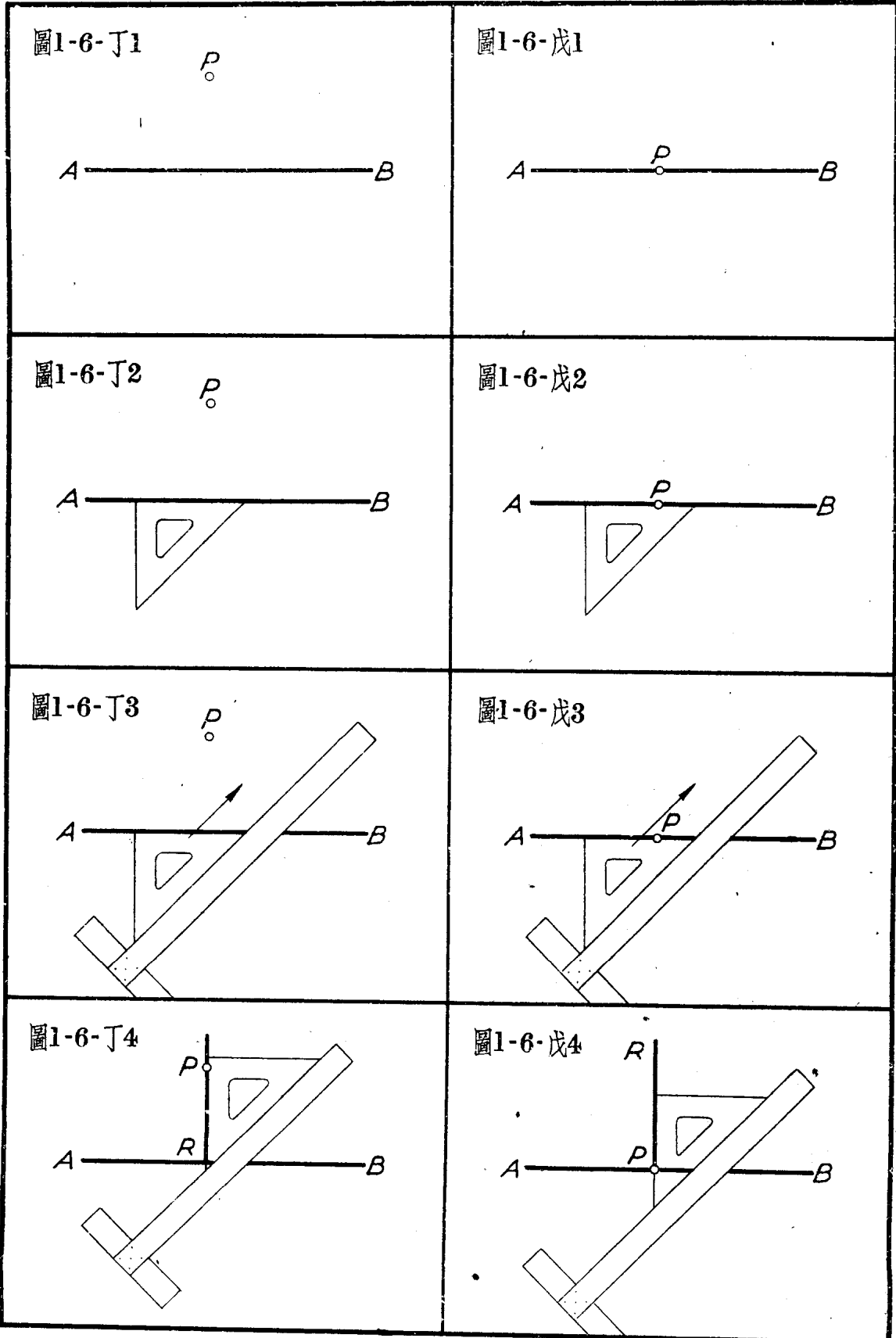

圖 1-10 正方形的作法(之一)

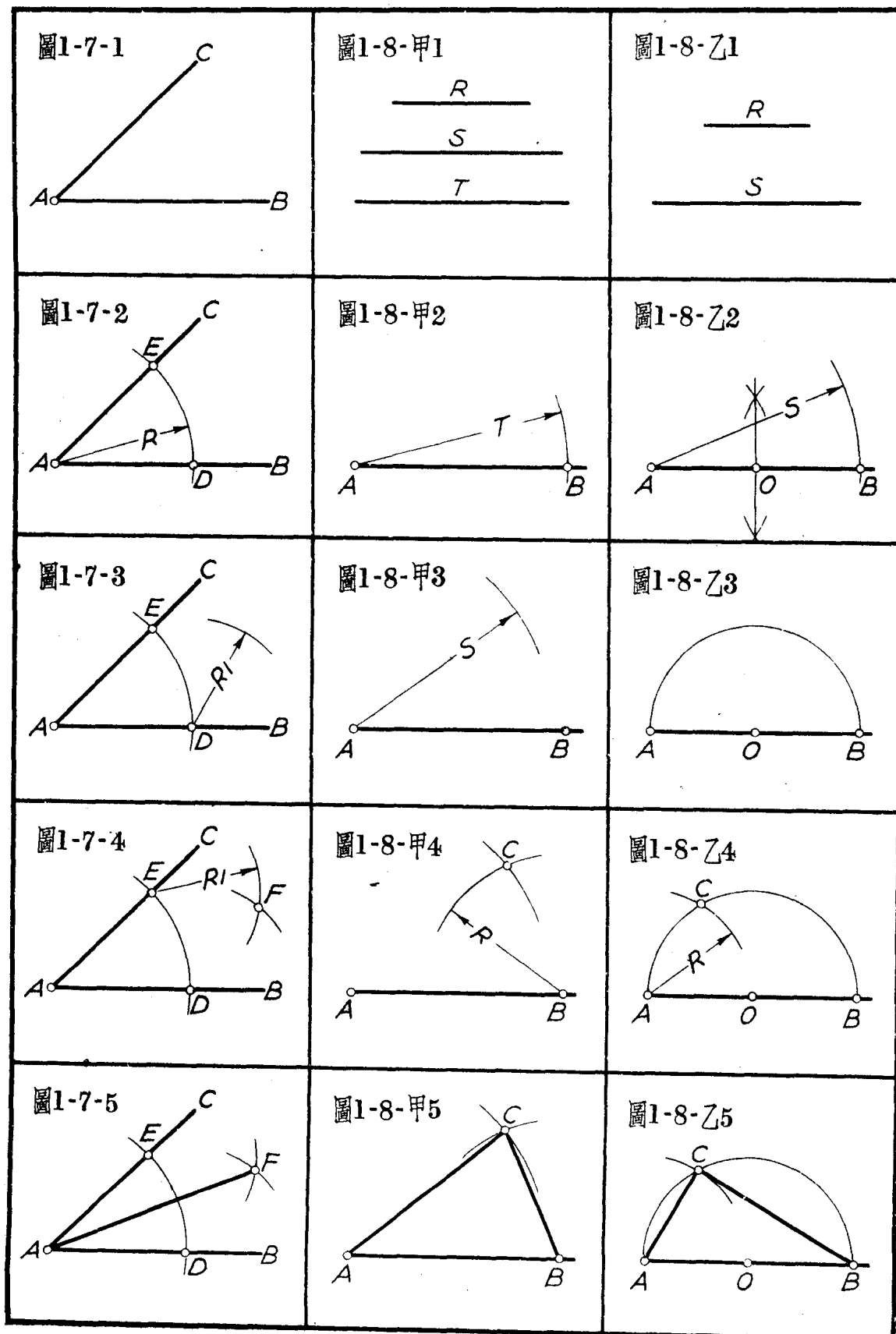

圖1-10-甲1

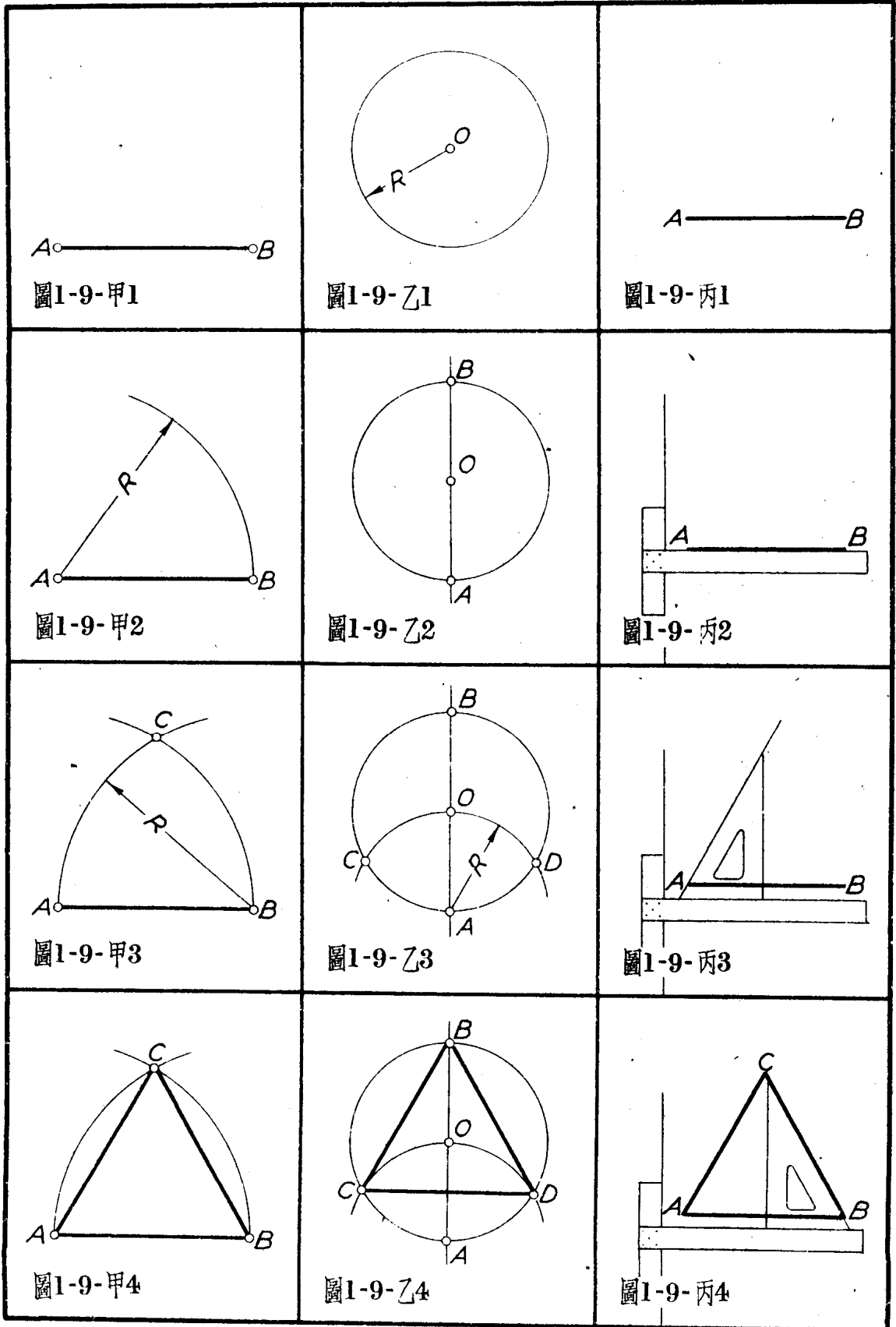

圖1-10-乙1



圖1-10-甲2

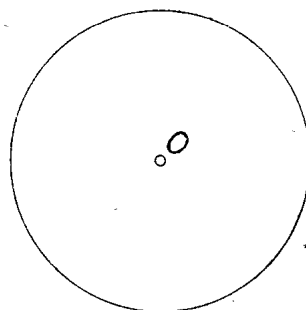

圖1-10-乙2

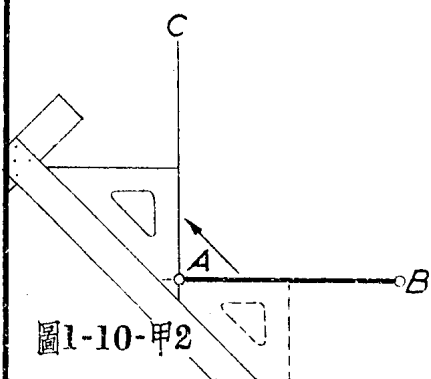

圖1-10-甲3

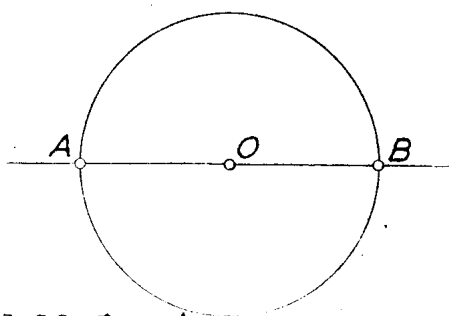

圖1-10-乙3

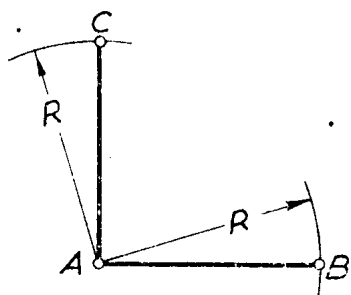

圖1-10-甲4

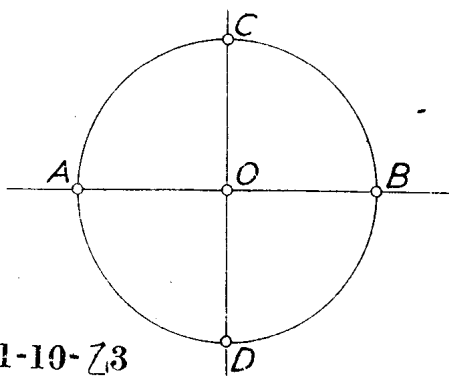

圖1-10-乙4

圖1-10 正方形的作法(之二)

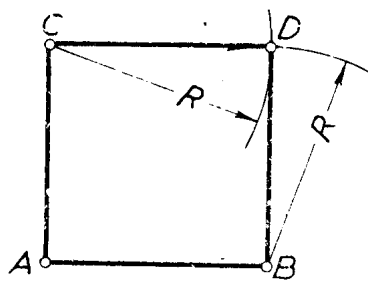
圖1-10-丙1

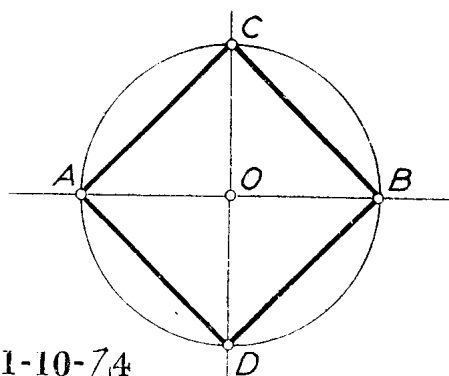

圖1-10-丁1



圖1-10-丙2



圖1-10-丁2

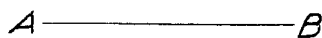

圖1-10-丙3

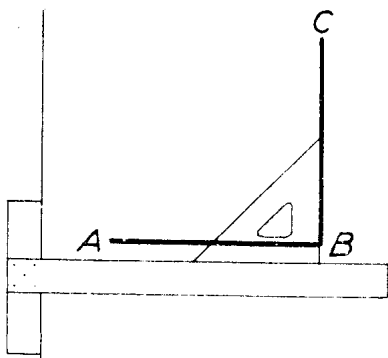

圖1-10-丁3

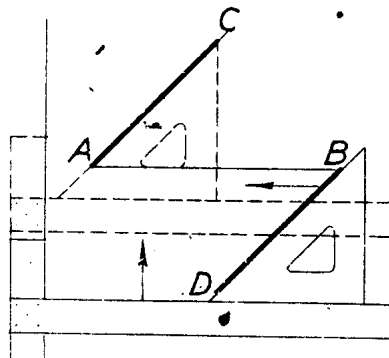

圖1-10-丙4

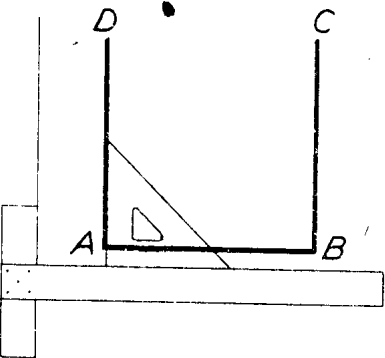

圖1-10-丁4



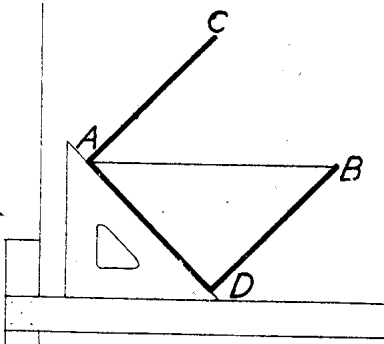

圖 1-11 正五邊形的作法

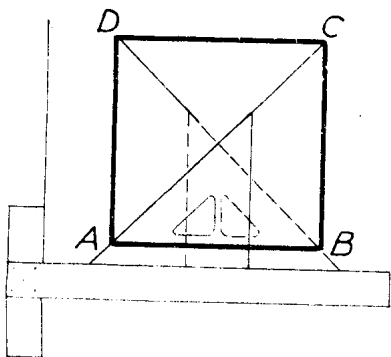
圖 1-12 任意正多邊形的作法

圖 1-11-1

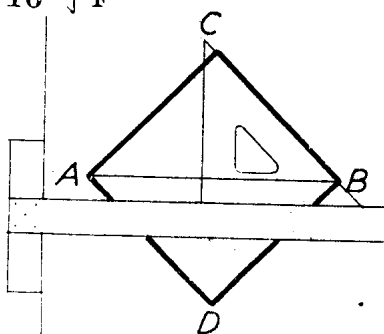

圖 1-12-1



圖 1-11-2

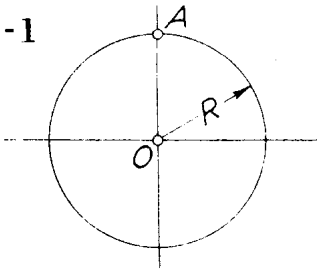

圖 1-12-2



圖 1-11-3

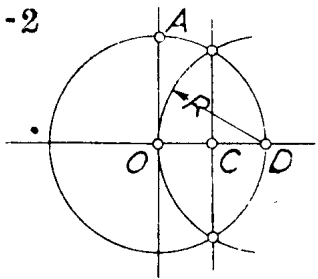

圖 1-12-3

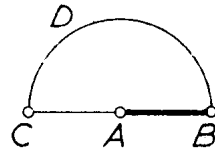

圖 1-11-4

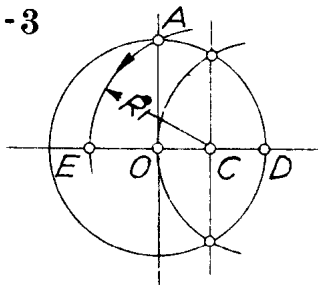

圖 1-12-4

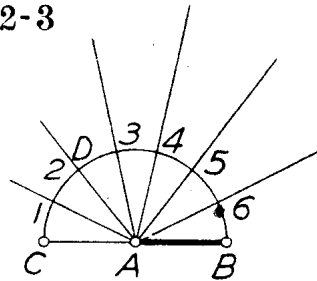

圖 1-11-5

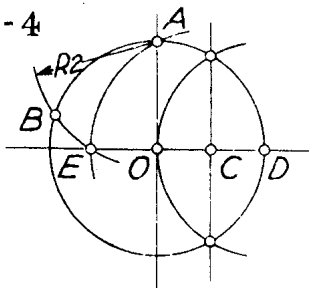

圖 1-12-5

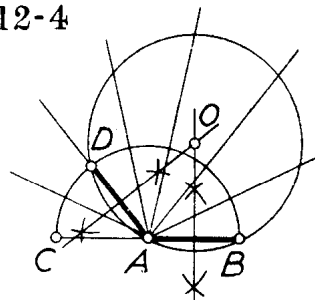
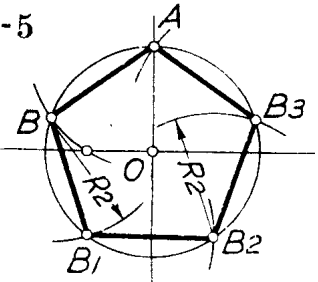