

第5章 标准件



祝允武。于鹤琴[⊖]

第1节 紧固件



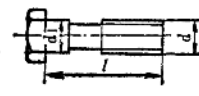
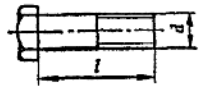
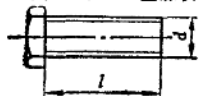

(一) 紧固件品种索引 (表 5-1-1)

表5-1-1 紧固件品种表



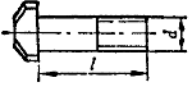

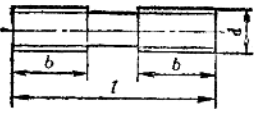
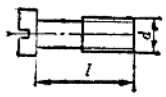
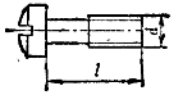

(mm)

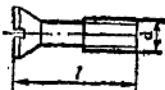

(1) 螺栓及螺柱			
名称与图形	标准号	旧标准号	表号
六角头螺栓—A和B级 	GB5782—86	GB30—76 GB21—76	5-1-2
六角头螺栓—全螺纹—A和B级 	GB5783—86	GB30—76 GB21—76	
六角头螺栓—细杆—B级 	GB5784—86	GB30—76 GB21—76	
六角头螺栓—细牙—A和B级 	GB5785—86	GB30—76 GB21—76	
六角头螺栓—细牙—全螺纹—A和B级 	GB5786—86	GB30—76 GB21—76	

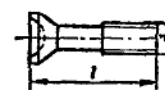
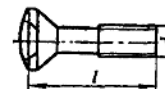
⊖ 本章第1节为祝允武编写，其余为于鹤琴编写。

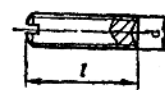
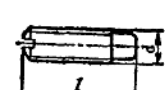
名称与图形	标准号	旧标准号	表号
T型槽用螺栓 	GB37—88	GB37—76	5-1-3
活节螺栓 	GB798—88	GB798—76	5-1-4
地角螺栓 	GB799—88	GB799—76	5-1-6
双头螺柱 	GB897~GB900—88	GB897~GB900—76	5-1-5
等长双头螺柱—B级 	GB901—88	GB901—76	5-1-7
等长双头螺柱—C级 	GB953—88	GB953—76	
(2) 螺 钉			
开槽圆柱头螺钉 	GB65—85	GB65—76	5-1-8
开槽盘头螺钉 	GB67—85	GB66—76 GB67—76	

(续)

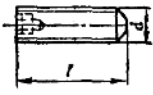
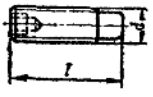

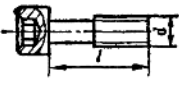
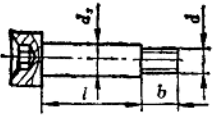
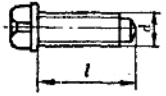
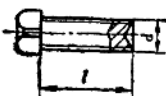
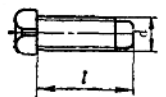
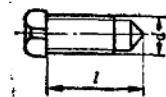
名称与图形	标准号	旧标准号	表号
开槽沉头螺钉 	GB68—85	GB68—76	5-1-9
开槽半沉头螺钉 	GB69—85	GB69—76	
十字槽盘头螺钉 	GB818—85	GB818—76 GB823—76	5-1-10
十字槽沉头螺钉 	GB819—85	GB819—76	
十字槽半沉头螺钉 	GB820—85	GB820—76	
开槽锥端紧定螺钉 	GB71—85	GB71—76	
开槽平端紧定螺钉 	GB73—85	GB73—76	
开槽凹端紧定螺钉 	GB74—85	GB74—76	5-1-11
开槽长圆柱端紧定螺钉 	GB75—85	GB75—76	5-1-12
内六角平端紧定螺钉 	GB77—85	GB77—76	

名称与图形	标准号	旧标准号	表号
内六角锥端紧定螺钉 	GB78—85	GB78—76	
内六角圆柱端紧定螺钉 	GB79—85	GB79—76	5-1-12
内六角凹端紧定螺钉 	GB80—85	GB80—76	
内六角圆柱头螺钉 	GB70—85	GB70—76	5-1-13
内六角圆柱头轴肩螺钉 	GB5281—85	—	5-1-14
方头长圆柱球面端紧定螺钉 	GB83—88	GB83—76	
方头凹端紧定螺钉 	GB84—88	GB84—76	
方头长圆柱端紧定螺钉 	GB85—88	GB85—76	5-1-16
方头短圆柱锥端紧定螺钉 	GB86—88	GB86—76	

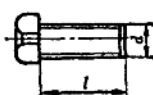
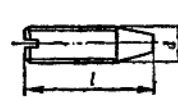
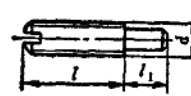
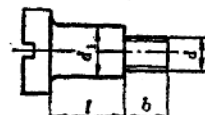
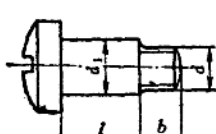
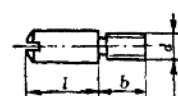
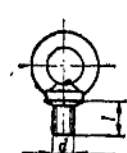
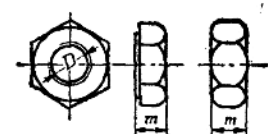
(续)

名称与图形	标准号	旧标准号	表号
方头倒角端紧定螺钉 	GB821—88	GB821—76	5-1-16
开槽锥端定位螺钉 	GB72—88	GB72—76	5-1-17
开槽圆柱端定位螺钉 	GB829—88	GB829—76	
开槽圆柱头轴位螺钉 	GB830—88	GB830—76	5-1-18
开槽球面圆柱头轴位螺钉 	GB946—88	GB946—76	
开槽无头轴位螺钉 	GB831—88	GB831—76	
吊环螺钉 	GB825—88	GB825—76	
(3) 螺母			
1型六角螺母 	GB6170—88 GB6171—88	GB51—76 GB52—76	5-1-21

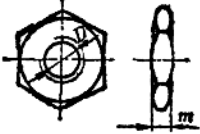
(续)

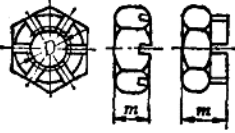
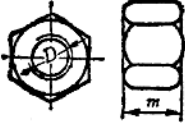
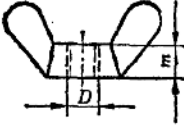
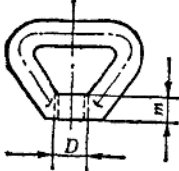
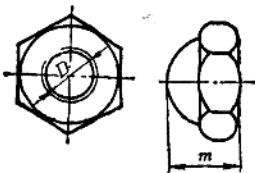
名称与图形	标准号	旧标准号	表号
<p>六角薄螺母</p> 	<p>GB6172-86 GB6173-86</p>	<p>GB53-76 GB54-76</p>	<p>5-1-22</p>
<p>2型六角螺母</p> 	<p>GB6175-86 GB6176-86</p>	<p>GB55-76</p>	<p>5-1-23</p>
<p>六角开槽螺母</p> 	<p>GB6178-86 GB6180-86</p>	<p>GB58-76 GB57-76</p>	<p>5-1-24</p>
<p>六角厚螺母</p> 	<p>GB56-88</p>	<p>GB56-76</p>	<p>5-1-25</p>
<p>蝶形螺母</p> 	<p>GB92-88</p>	<p>GB62-76</p>	<p>5-1-26</p>
<p>环形螺母</p> 	<p>GB68-88</p>	<p>GB63-76</p>	<p>5-1-27</p>
<p>盖形螺母</p> 	<p>组合式盖形螺母 GB802-88 盖形螺母 GB923-88</p>	<p>GB802-76 GB923-76</p>	<p>5-1-28</p>

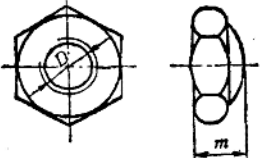
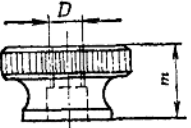
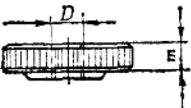
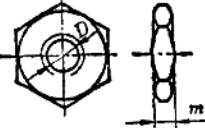
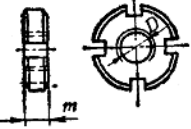
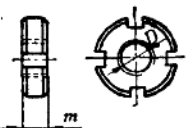
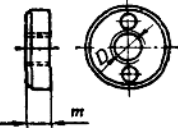

(续)

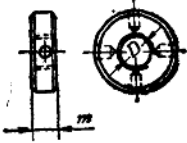
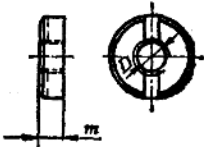
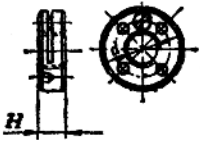
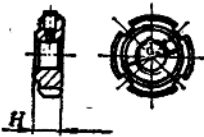
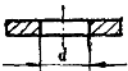
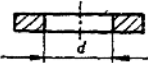
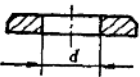
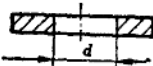

名称与图形	标准号	旧标准号	表号
球面六角螺母 	GB804—88	GB804—76	5-1-29
滚花高螺母 	GB806—88	GB806—76	5-1-30
滚花薄螺母 	GB807—88	GB807—76	
小六角特扁细牙螺母 	GB808—88	GB808—76	5-1-31
小圆螺母 	GB810—88	GB810—76	5-1-32
圆螺母 	GB812—88	GB812—76	5-1-33
端面带孔圆螺母 	GB815—88	GB815—76	5-1-34

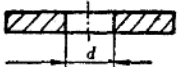
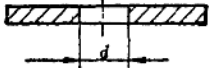
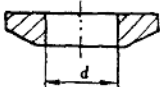
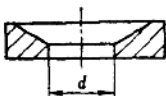
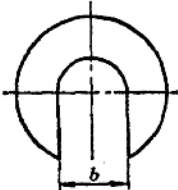
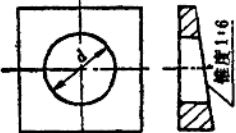
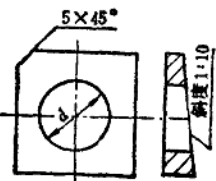

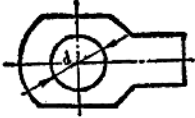
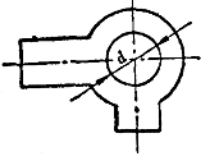
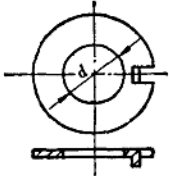
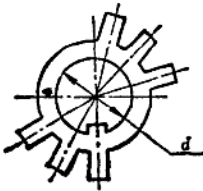
名称与图形	标准号	旧标准号	卷号
侧面带孔圆螺母 	GB816—88	GB816—76	5-1-34
带槽圆螺母 	GB817—88	GB817—76	5-1-35
带锁紧槽圆螺母 	JB24—59	J14—5 K14—5	5-1-36
带锁紧块圆螺母 	压块锁紧螺母 GC124—60 垫块锁紧螺母 JB23—59	J14—1, K14—1 J14—6, K14—6	5-1-37
(4) 垫圈			
小垫圈—A级 	GB848—85	GB848—76	5-1-40
平垫圈—A级 	GB97.1—85	GB97—76A	
平垫圈倒角型—A级 	GB97.2—85	GB97—76B	
平垫圈—C级 	GB95—85	GB95—76	

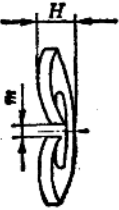
(续)

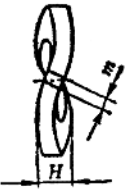
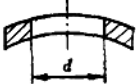
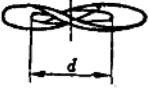
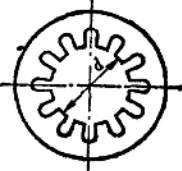
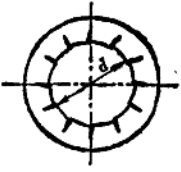
名称与图形	标准号	旧标准号	表号
大垫圈—A级和C级 	GB96—85	GB96—76	5-1-41
特大垫圈—C级 	GB5287—85		
球面垫圈 	GB849—88	GB849—76	5-1-42
锥面垫圈 	GB850—88	GB850—76	
开口垫圈 	GB851—88	GB851—76	5-1-43
工字钢用方斜垫圈 	GB852—88	GB852—76	5-1-44
槽钢用方斜垫圈 	GB853—88	GB853—76	

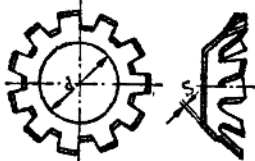
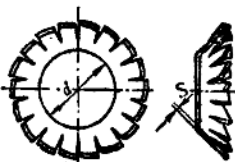
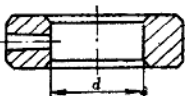

名称与图形	标准号	旧标准号	表号
单耳止动垫圈 	GB854—88	GB854—76	5-1-45
双耳止动垫圈 	GB855—88	GB855—76	
外舌止动垫圈 	GB856—88	GB856—76	5-1-46
圆螺母用止动垫圈 	GB858—88	GB858—76	5-1-47
弹簧垫圈 	标准型 GB93—87 轻型 GB859—87 重型 GB7244—87	标准 GB93—76 轻型 GB859—76	5-1-48
板形弹簧垫圈 	GB7245—87		5-1-49

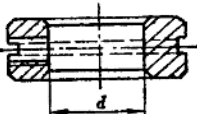
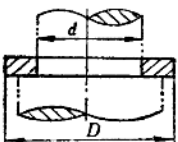
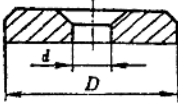
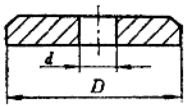

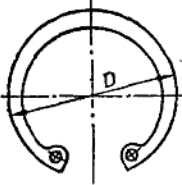
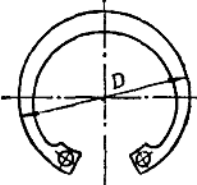
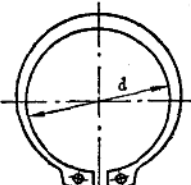
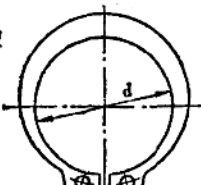
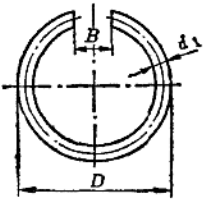
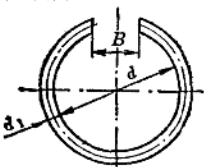

名称与图形	标准号	旧标准号	表号
波形弹簧垫圈 	GB7246—87		5-1-49
鞍形弹性垫圈 	GB860—87	GB860—76	5-1-50
波形弹性垫圈 	GB955—87	GB955—76	5-1-51
内齿锁紧垫圈 	GB861.1—87	GB861—76	5-1-52
内锯齿锁紧垫圈 	GB861.2—87		
外齿锁紧垫圈 	GB862.1—87	GB861—76	
外锯齿锁紧垫圈 	GB862.2—87		

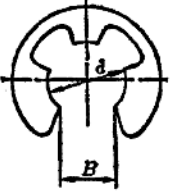
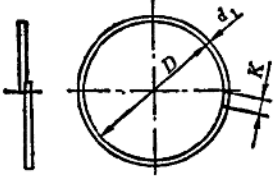
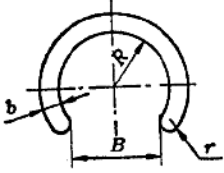
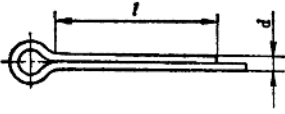
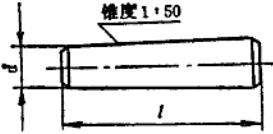
名称与图形	标准号	旧标准号	表号
锥形锁紧垫圈 	GB956.1—87	GB956—76	5-1-53
锥形锯齿锁紧垫圈 	GB956.2—87		5-1-53
(5) 挡圈			
锥形锁紧挡圈 	GB883—86	GB883—76	5-1-54
螺钉锁紧挡圈 	GB884—86	GB884—76	
带锁圈的螺钉锁紧挡圈 	GB885—86	GB885—76	
轴肩挡圈 	GB886—86	GB886—76	
螺钉紧固轴端挡圈 	GB891—86	GB891—76	5-1-56
螺栓紧固轴端挡圈 	GB892—86	GB892—76	5-1-56

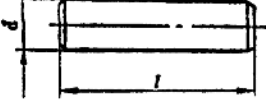
(续)

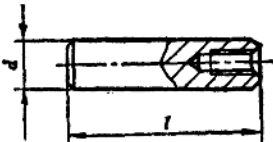
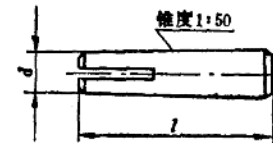
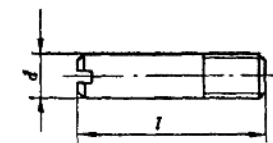
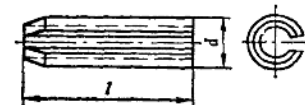
名称与图形	标准号	旧标准号	表号
孔用弹性挡圈 A型 	GB893.1-86	GB893-76	5-1-57
孔用弹性挡圈 B型 	GB893.2-86		5-1-58
轴用弹性挡圈 A型 	GB894.1-86	GB894-76	5-1-59
轴用弹性挡圈 B型 	GB894.2-86		5-1-60
孔用钢丝挡圈 	GB895.1-86	GB895-76	5-1-61
轴用钢丝挡圈 	GB895.2-86	GB895-76	5-1-62

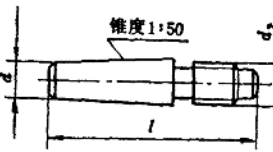
名称与图形	标准号	旧标准号	表号
开口挡圈 	GB896—86	GB896—76	5-1-63 5-1-64
钢丝锁圈 	GB921—86	GB921—76	5-1-65
夹紧挡圈 	GB960—86	GB960—76	5-1-66
(6) 销			
开口销 	GB91—86	GB91—76	5-1-67
圆锥销 	GB117—86	GB117—76	5-1-68
内螺纹圆锥销 	GB118—86	GB118—76	5-1-69
圆柱销 	GB119—86	GB119—76	5-1-73

名称与图形	标准号	旧标准号	表号
内螺纹圆柱销 	GB120—86	GB120—76	5-1-72
开尾圆锥销 	GB877—86	GB877—76	5-1-70
螺纹圆柱销 	GB878—86	GB878—76	5-1-74
弹性圆柱销 	GB879—86	GB879—76	5-1-76
带孔销 	GB880—86	GB880—76	5-1-75
螺尾锥销 	GB881—86	GB881—76	5-1-71
销轴 	GB882—86	GB882—76	5-1-77

(二) 螺栓与螺柱 (表5-1-2至表5-1-7)

表5-1-2 六角

六角头螺栓—A和B级 (GB5782—86)

六角头螺栓—全螺纹—A和B级 (GB5783—86)

六角头螺栓—细牙—A和B级 (GB5785—86)

六角头螺栓—细牙—全螺纹—A和B级 (GB5786—86)

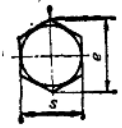
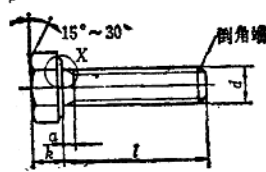
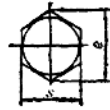
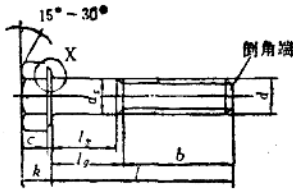

X放大

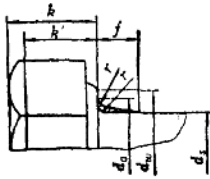

X放大

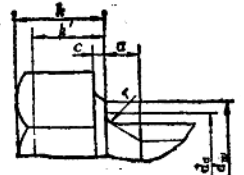

允许制造的形式

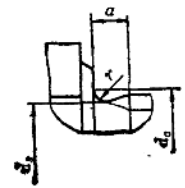

d (螺纹规格)		M 3	M 4	M 5	M 6	M 8	M 10	M 12	
P (螺距)	GB57 ⁸² / ₈₃ —86	0.5	0.7	0.8	1	1.25	1.5	1.75	
	GB5784—86	0.5	0.7	0.8	1	1.25	1.5	1.75	
	GB57 ⁸⁵ / ₈₆ —86	—	—	—	—	1	1(1.25)	1.5(1.25)	
c 范围	GB57 ^{82, 83} / _{85, 86} —86	0.15~0.4		0.15~0.5		0.15~			
d ₀ max	GB57 ⁸² / _{85, 86} —86	3.6	4.7	5.7	6.8	9.2	11.2	13.7	
	GB5783—86	3.6	4.7	5.7	6.8	9.2	11.2	13.7	
	GB5784—86	3.6	4.7	5.7	6.8	9.2	11.2	13.7	
d ₀ (公差)	GB57 ⁸² / ₈₅ —86	A	3 ⁽⁰⁾ / _(-0.14)	4 ⁽⁰⁾ / _(-0.18)	5 ⁽⁰⁾ / _(-0.18)	6 ⁽⁰⁾ / _(-0.18)	8 ⁽⁰⁾ / _(-0.22)	10 ⁽⁰⁾ / _(-0.22)	12 ⁽⁰⁾ / _(-0.27)
		B	—	—	5 ⁽⁰⁾ / _(-0.3)	6 ⁽⁰⁾ / _(-0.3)	8 ⁽⁰⁾ / _(-0.36)	10 ⁽⁰⁾ / _(-0.36)	12 ⁽⁰⁾ / _(-0.43)
	GB57 ⁸³ / ₈₆ —86	d ₀ ~螺紋							
d ₀ min	GB57 ⁸² / ₈₃ —86	A	4.6	5.9	6.9	8.9	11.6	14.6	16.6
		B	—	—	6.7	8.7	11.4	14.4	16.4
	GB5784—86	B	4.4	5.7	6.7	8.7	11.4	14.4	16.4
	GB57 ⁸⁵ / ₈₆ —86	A	—	—	—	—	11.6	14.6	16.6
B		—	—	—	—	11.4	14.4	16.4	
e min	GB57 ⁸² / ₈₃ —86	A	6.07	7.66	8.79	11.05	14.38	17.77	20.03
		B	—	—	8.63	10.89	14.20	17.59	19.85

头螺栓

(mm)

六角头螺栓—细杆—B级 (GB5784—86)

说明: 1. 末端按GB2—85规定 2. d_r —螺纹中径

标记示例:

螺栓GB5782—86—M12×80($d = M12$, 公称长度 $l = 80$ mm, 性能等级为8.8级, 表面氧化, A级的六角头螺栓)

螺栓GB5783—86—M12×80($d = M12$, 公称长度 $l = 80$ mm, 性能等级为8.8级, 表面氧化, 全螺纹, A级的六角头螺栓)

螺栓GB5784—86—M12×80($d = M12$, 公称长度 $l = 80$ mm, 性能等级为5.8级, 不经表面处理, B级的六角头螺栓)

螺栓GB5785—86—M12×1.5×80($d = M12 \times 1.5$, 公称长度 $l = 80$ mm, 性能等级为8.8级, 表面氧化, A级的六角头螺栓)

螺栓GB5786—86—M12×1.5×80($d = M12 \times 1.5$, 公称长度 $l = 80$ mm, 性能等级为8.8级, 表面氧化, 全螺纹, A级的六角头螺栓)

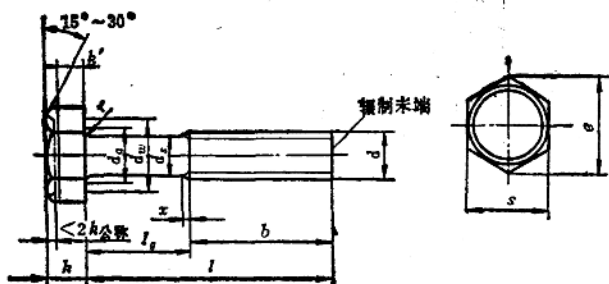

(M14)	M16	M20	M24	M30	M36	M42	M48	M56	M64
2	2	2.5	3	3.5	4	4.5	5	5.5	6
2	2	2.5	—	—	—	—	—	—	—
1.5	1.5	2(1.5)	2	2	3	3	3	4	4
0.6	0.2~0.8					0.3~1			
15.7	17.7	22.4	26.4	33.4	39.4	45.6	52.6	63	71
15.7	17.7	22.4	26.4	33.4	39.4	48.6	56.6	67	75
15.7	17.7	22.4	—	—	—	—	—	—	—
14 $\left(\begin{smallmatrix} 0 \\ -0.27 \end{smallmatrix}\right)$	16 $\left(\begin{smallmatrix} 0 \\ -0.27 \end{smallmatrix}\right)$	20 $\left(\begin{smallmatrix} 0 \\ -0.33 \end{smallmatrix}\right)$	24 $\left(\begin{smallmatrix} 0 \\ -0.33 \end{smallmatrix}\right)$	—	—	—	—	—	—
14 $\left(\begin{smallmatrix} 0 \\ -0.43 \end{smallmatrix}\right)$	16 $\left(\begin{smallmatrix} 0 \\ -0.43 \end{smallmatrix}\right)$	20 $\left(\begin{smallmatrix} 0 \\ -0.52 \end{smallmatrix}\right)$	24 $\left(\begin{smallmatrix} 0 \\ -0.52 \end{smallmatrix}\right)$	30 $\left(\begin{smallmatrix} 0 \\ -0.52 \end{smallmatrix}\right)$	36 $\left(\begin{smallmatrix} 0 \\ -0.62 \end{smallmatrix}\right)$	42 $\left(\begin{smallmatrix} 0 \\ -0.62 \end{smallmatrix}\right)$	48 $\left(\begin{smallmatrix} 0 \\ -0.62 \end{smallmatrix}\right)$	56 $\left(\begin{smallmatrix} 0 \\ -0.74 \end{smallmatrix}\right)$	64 $\left(\begin{smallmatrix} 0 \\ -0.74 \end{smallmatrix}\right)$

中径

19.6	22.5	28.2	33.6	—	—	—	—	—	—
19.2	22	27.7	33.2	42.7	51.1	60.6	69.4	78.7	88.2
19.2	22	27.7	—	—	—	—	—	—	—
19.6	22.5	28.2	33.6	—	—	—	—	—	—
19.2	22	27.7	33.2	42.7	51.1	60.6	69.4	78.7	88.2
23.35	26.75	33.53	39.98	—	—	—	—	—	—
22.78	26.17	32.95	39.55	50.85	60.79	72.02	82.6	93.56	104.86