

T3957.14/3

12799

153 款新潮 连衣裙裁剪法



编 / 栢燕

出版 / 上海交通大学出版社

153 KUAN LIAN YI QUN

153 款新潮 连衣裙裁剪法

编 / 栢燕

出版 / 上海交通大学出版社

153 款 连 衣 裙

现代生活丛书

出 版：上海交通大学出版社
(淮海中路1984弄19号)

发 行：新华书店上海发行所

印 刷：太仓印刷厂

开 本：787×1092(毫米)1/16

印 张：8.25

版 次：1989年4月第1版

印 次：1989年4月第1次

印 数：1—55000

科 目：196—318

ISBN7—313—00505—9/TS·957

定价：6.50元

前 言

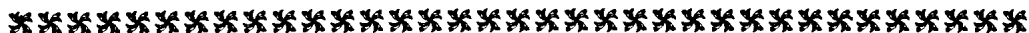

新颖、自然、舒适、富于表现是当今服装流行的总趋势。每一位爱美的女士总希望穿着潇洒、随和、简洁的服装来表现自己的个性美。这美的追求恰恰是四化建设中精神文明和物质文明的反映。同时是物质生活的需要,也是文化艺术水平的表现。

如何去追求生活中最佳、最和谐的美丽服装呢?如何把自己打扮得美而不妖、雅而不俗、实用舒适、得体大方呢?本出版社付出艺术再创作的艰苦劳动为你开避了一个选美的艺术天地,向你推出这套不可多得的新颖连衣裙。这些款式以表现东方情趣的造型为主题。融新潮设计于一炉,集艺术与实用为一体。

本书为了方便广大女士及裁剪爱好者自缝的需要,在每一件连衣裙款式中都详例了裁剪图解。即使只懂得一点缝纫知识也能参考书介绍的量身方法、制图方法、制图记号、服装尺寸参考表,就可以自缝、缝制出适合自己的新服装。

生活应该闪耀七彩阳光。奇彩缤纷的新潮连衣裙是当代女性婀娜的魅力所在。

上海交通大学出版社

目 录

缝纫基础知识

量身方法·····	2
裁剪方法·····	3
裁剪记号·····	5
连衣裙尺寸参考表·····	6

153款连衣裙

长袖连衣裙·····	7
短袖连衣裙·····	55
无袖连衣裙·····	98

量身方法

无论缝制任何衣服，都得量取人体各部的正确尺寸，这样缝制出来的服装，才能与穿着者的体型相配合，从而加添美观。下面是简单的量身方法：

一胸围：从前胸开始，软尺经腋下绕背面围量一周。（根据原料性能，穿者习惯等灵活加放一定尺寸）

二背长：由颈后中间向下量至腰部。

三背肩阔：从左肩骨平量至右肩骨。（女夏装肩阔尺寸不宜量得太阔，紧一些为好。）

四腰围：在腰部最细处围量一周。（加放一定尺寸。）

五腰长：由腰至臀的距离长度。

六臀围：在臀部最丰满处围量一周。（加放一定尺寸。）

七袖长：从肩骨外端向下量至所需长度为止。

八肩至袖长：从颈后中间至肩尖，再向下量至手腕。

九总长：由肩尖量至地面。

十领围：在头颈最细处围量一周。（加放一定尺寸。）

十一裙长：自腰部最细处起，向下量至所需长度止。

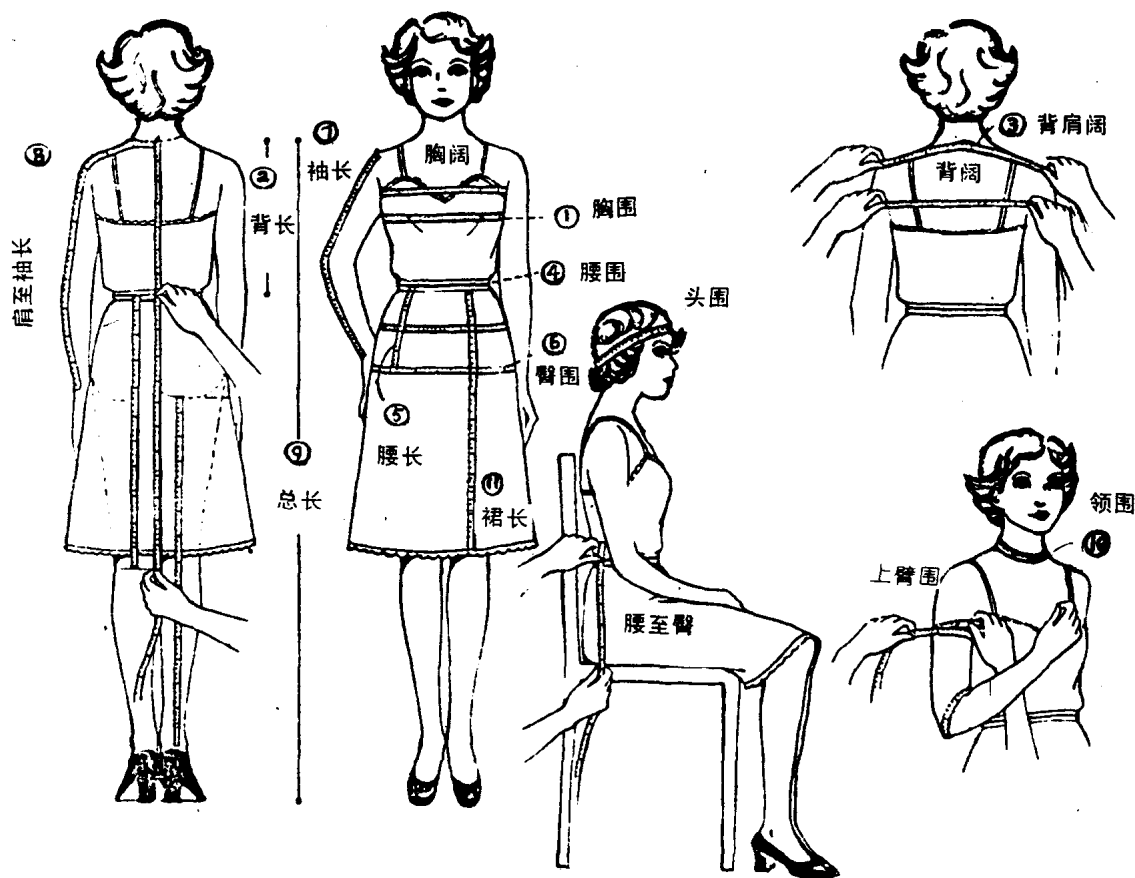

裁剪方法

正确量取尺寸后，接着便是绘画基本图。绘画基本图，是以胸围、背长和袖长的尺寸为
基础线。

前后片画法

AB是背长线(后片中间线);BD是 $\frac{1}{2}$ 胸围尺寸+5cm, AC与BD平行;连结CD成一直线
(前片中间线);AF是 $\frac{1}{6}$ 胸围尺寸+7cm;FE与BD及AC平行;FJ是 $\frac{1}{6}$ 胸围尺寸+4.5cm,
RE是 $\frac{1}{6}$ 胸围尺寸+3cm;画出IJ和GR;KR线是由FE线的中间向左移0.5的位置,再垂直向
下画出;前后领弯阔度均是 $\frac{1}{20}$ 胸围尺寸+2.7cm;前领弯低 $\frac{1}{20}$ 胸围尺寸+1cm;最后按照图
示比例画出袖弯等线。

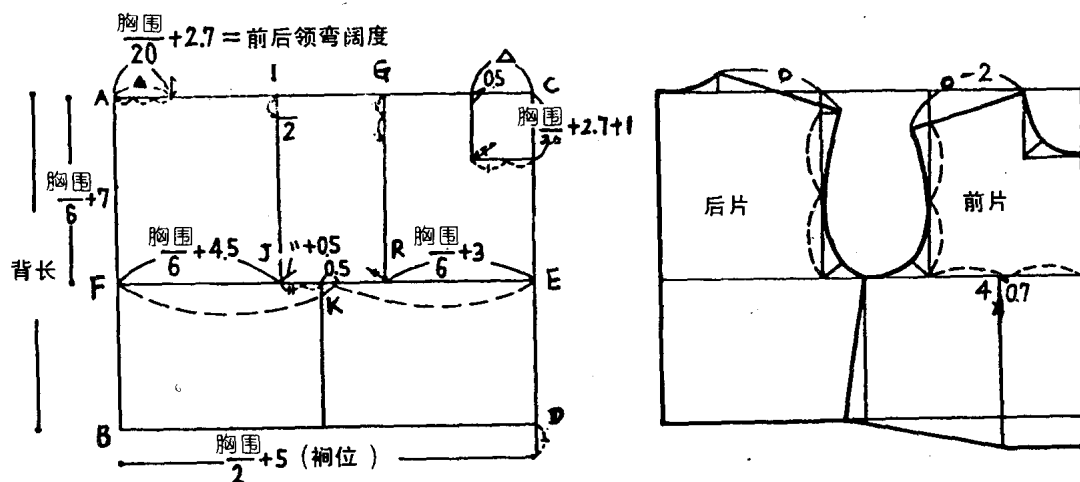

袖 画 法

AB是袖长，AI袖山高是 $\frac{1}{4}$ 袖弯尺寸+3cm，AJ肘高线是 $\frac{1}{2}$ 袖长尺寸+2.5cm；接着分别从B、I、及J处划一水平线。后袖山基本线AC的长度，是取前片袖弯尺寸加后片袖弯尺寸之半+1.5cm；前袖山基本线AD长度，则是前后片袖弯尺寸之和的一半。分别后C和D引划垂直线，与B水平线相交之点分别定为G和H。袖山线的完成，首先是把前后袖山基本线各分为四等分，并依图示的数字增减尺寸幅度划出弧形线条。把袖口基本线GB和BH分为二分，G缩进1cm、BH中点向左偏入1.5cm、H缩进1cm，连结各点划出袖口线。

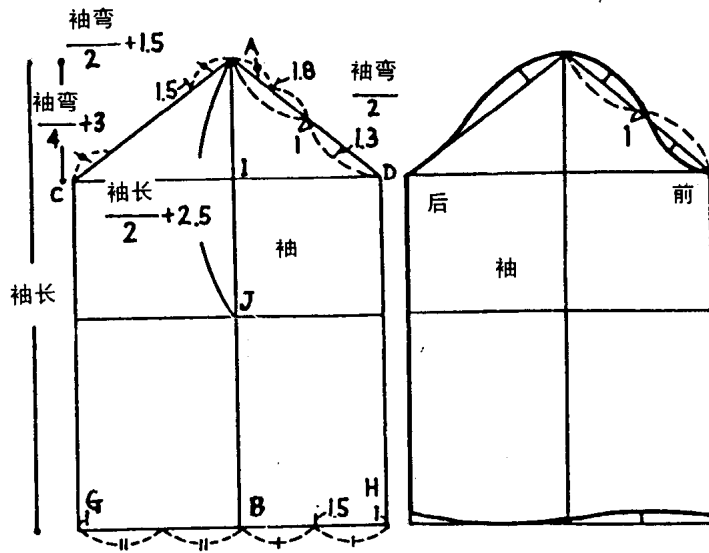

裁剪符号

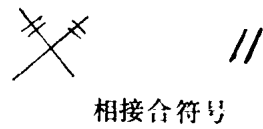
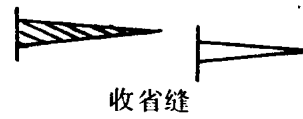
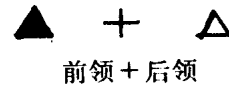
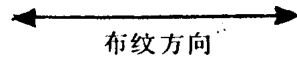
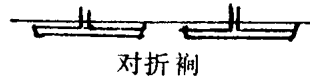
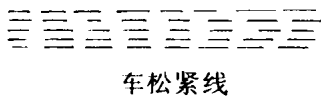
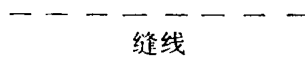
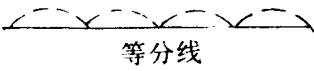
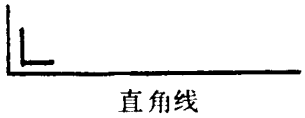
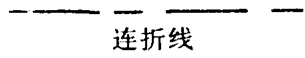
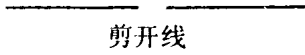
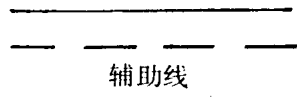
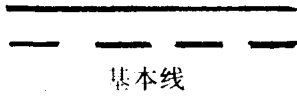

连衣裙尺寸参考规格表： (单位cm)

位置	S(小)	M(中)	L(大)
胸围	77	83	95
腰围	59	63	73
臀围	85	89	99
上臂围	25	27	29
手颈围	16	17	18
头围	56	57	58
领围	37	38	40
身长	151	156	161
总长	131	134	139
背长	37	38	40
腰长	18	19	21
腰至臀	26	27	29
袖长	51	53	54
背肩阔	39	40	41
背阔	35	36	38
胸阔	33	35	38



用料:

面料 90 cm × 420 cm
 夹里 (袖不用) 170 cm

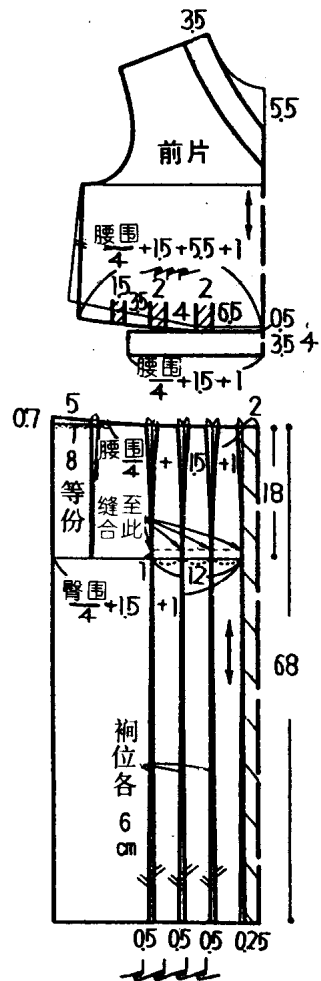
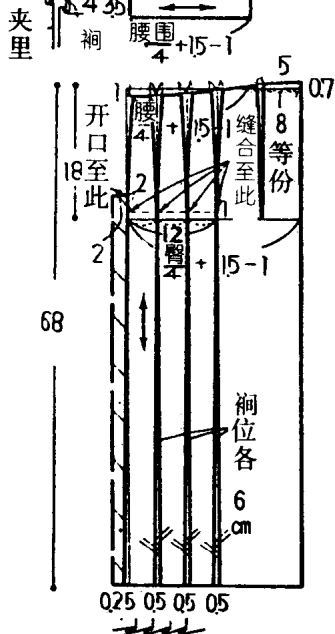
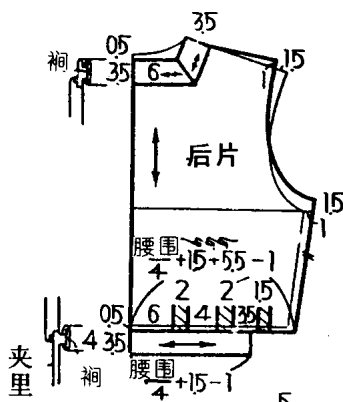
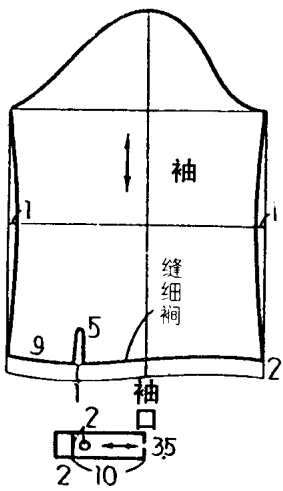
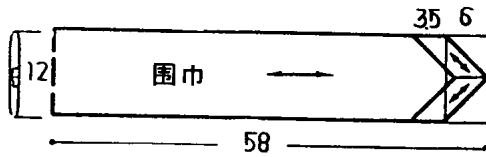



用料:
面料 90 cm X 310 cm
夹里 (裙用) 150 cm

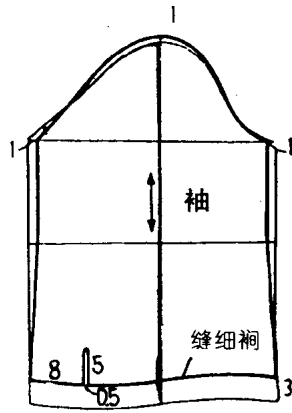

克夫 其它布
2 9.5 4

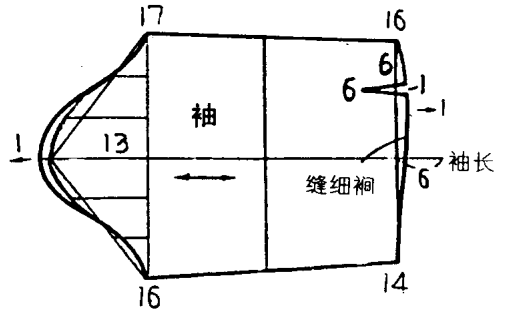

克夫 6.5
2 1.5 2 1.5 1.5 2 10

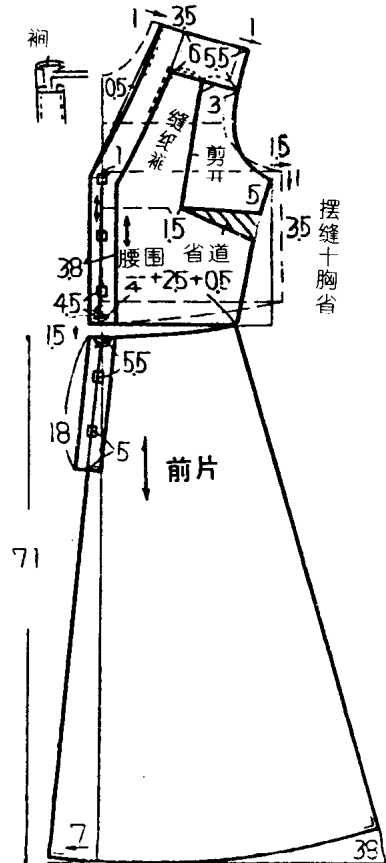
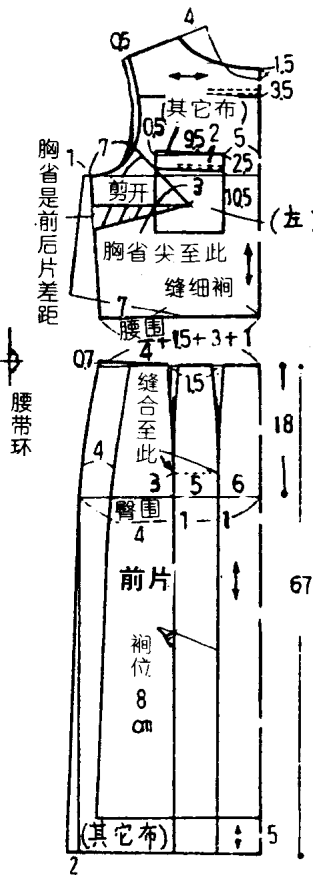
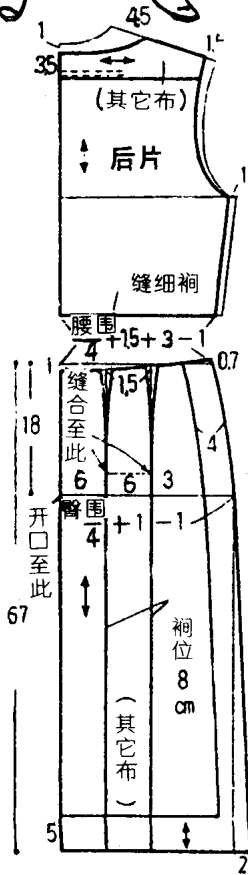

用料:

面料用双幅布 190 cm
 夹里 90 cm X 270 cm

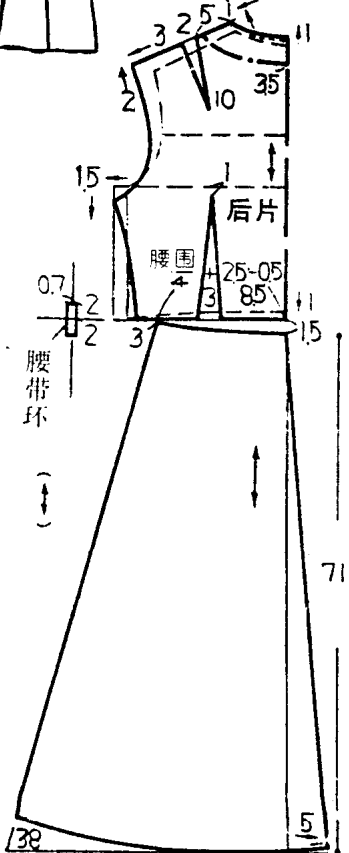
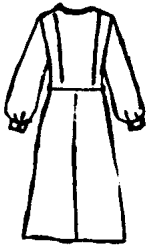
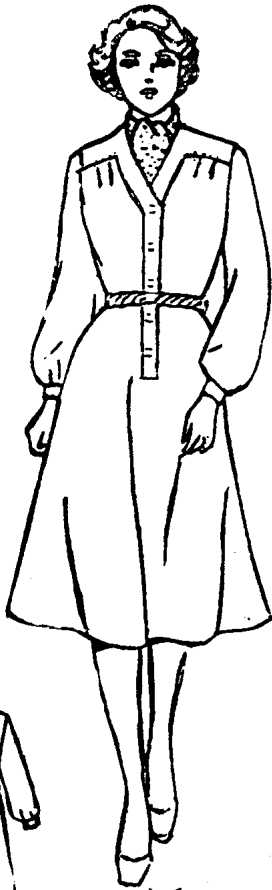

用料:

面料 90 cm X 370 cm
 夹里 (袖不用) 210 cm

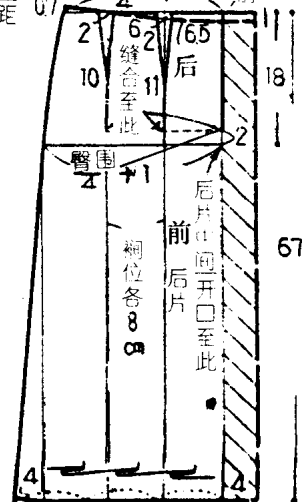
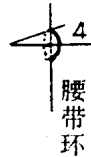
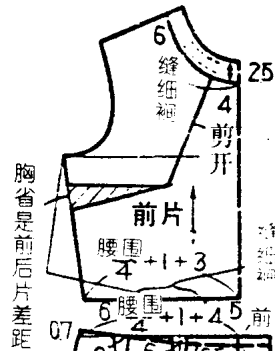
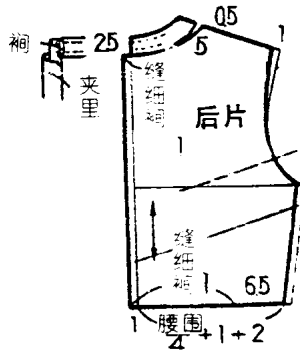
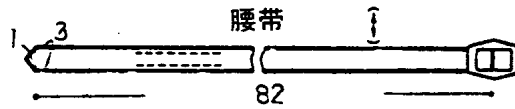
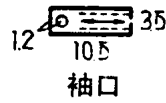
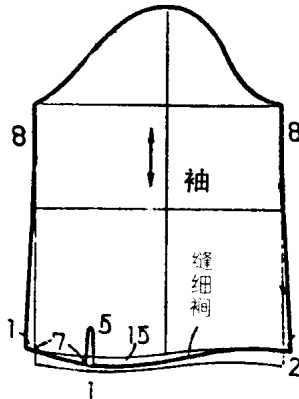

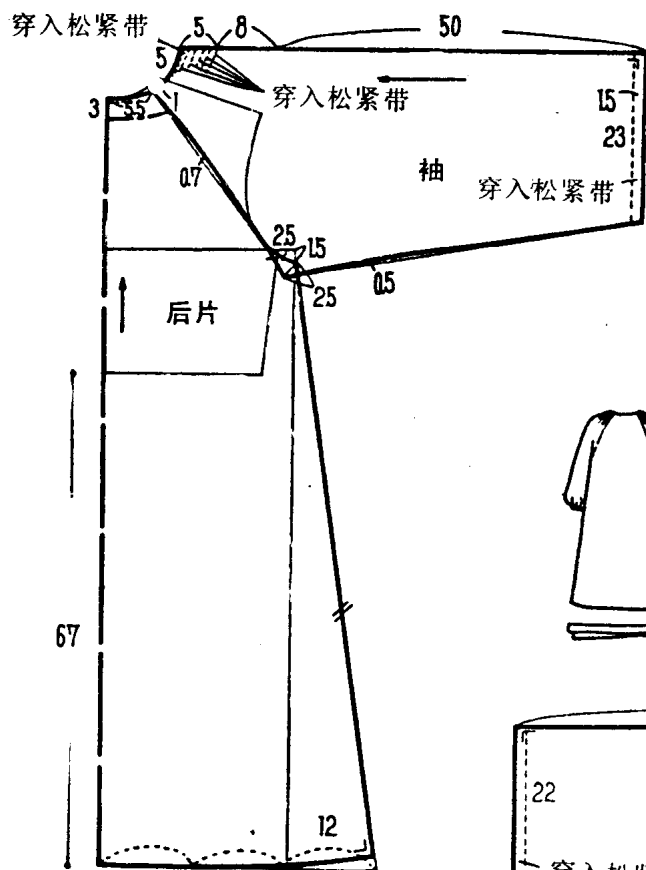

用料：面料 90 cm × 370 cm

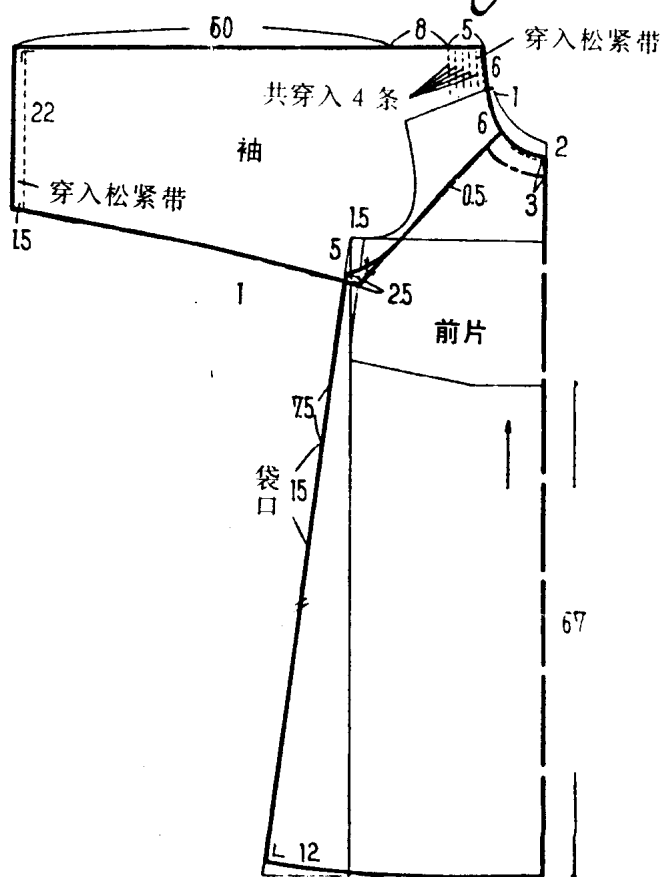

腰带

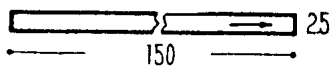

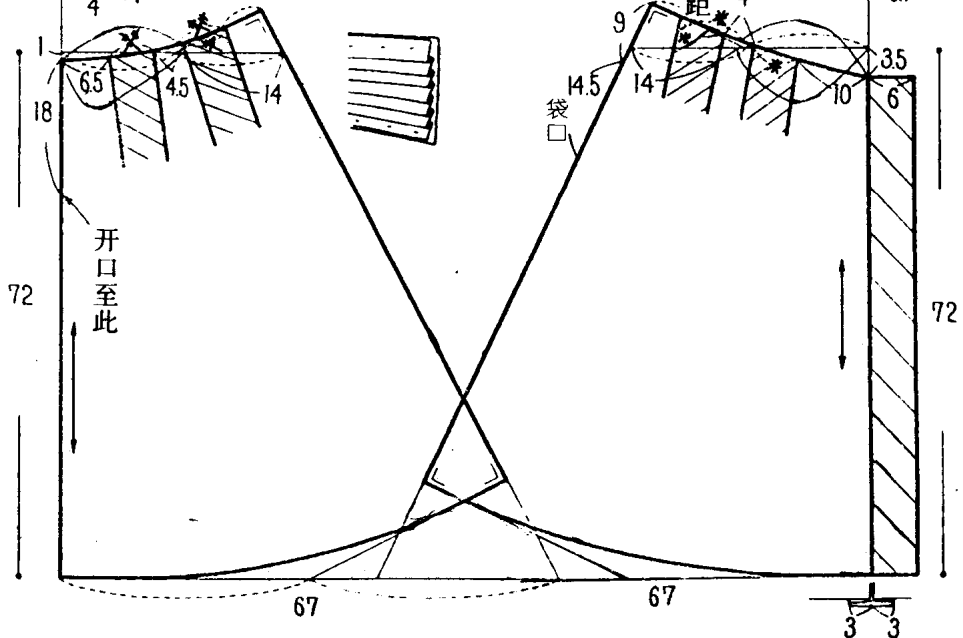
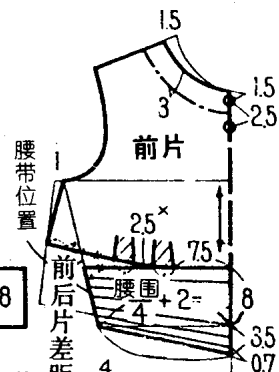
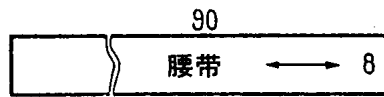
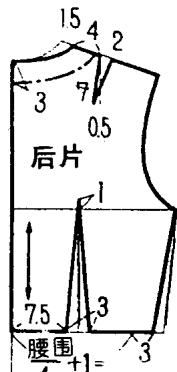
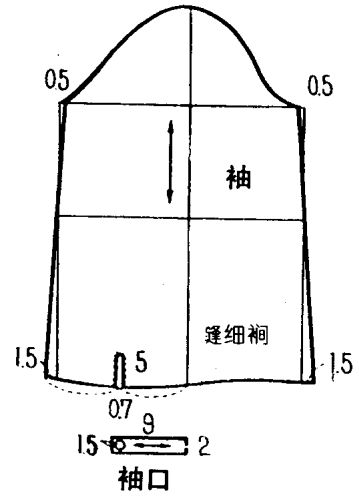
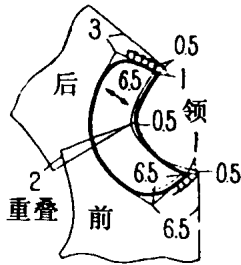

用料:

面料 90 cm × 230 cm (袖不用)
 夹里 90 cm × 380 cm

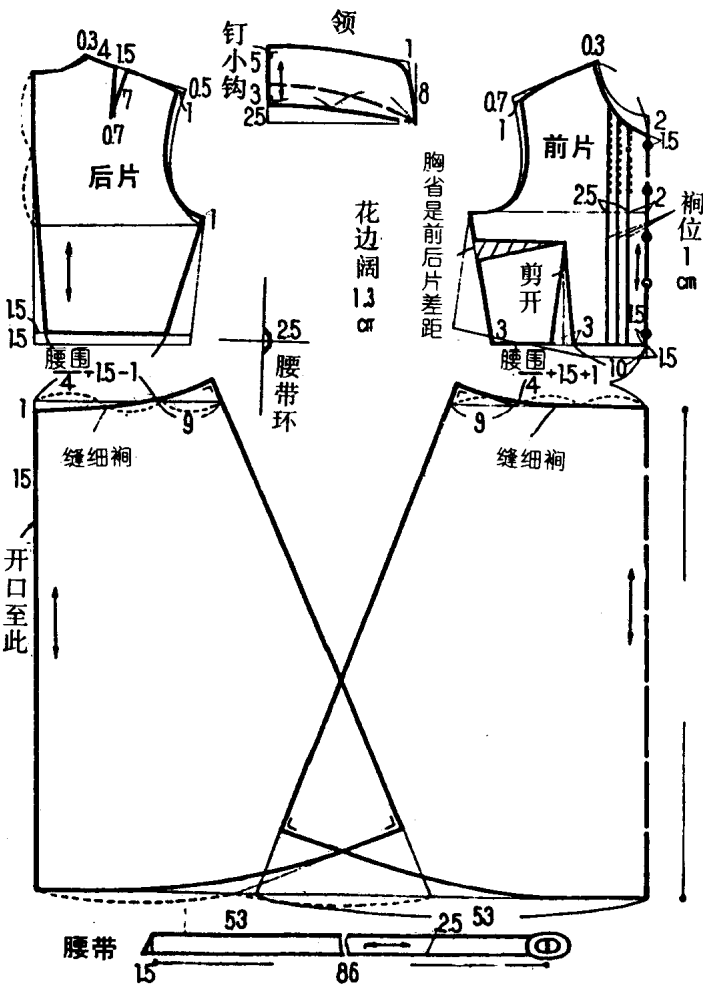
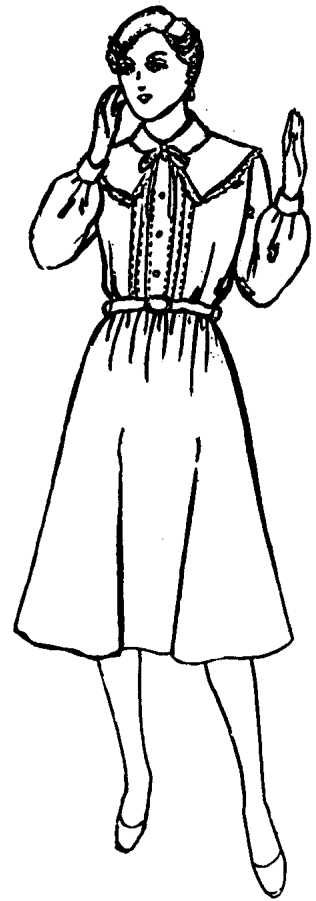
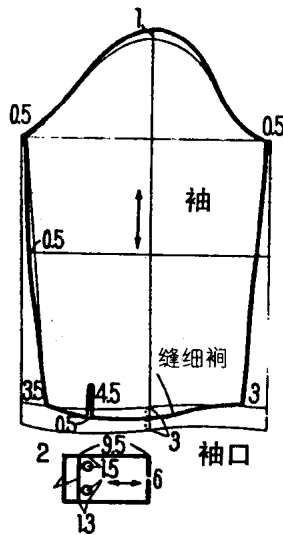
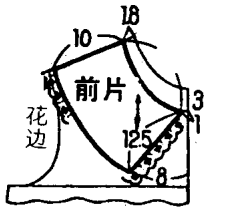
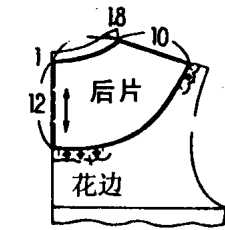
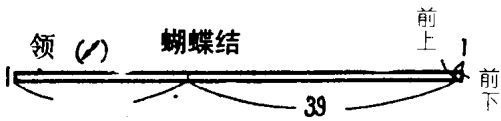

用料: 面料用双幅布 220 cm
夹里 90 cm × 220 cm



