

—  
**京J71**  
—

北京市基本建设委员会批准

建筑配件图集

# 平开空腹钢窗

—  
北京市建筑设计院 编制  
1980  
—

# 平开空腹钢窗

京J71































































































负责人 总工程师 张德清  
 室主任 总工程师 傅玉良  
 组长 沈致文 设计负责人 陶伯贤

## 目 录

## 说 明

目 录	说明	页 1
外 平 开 钢 窗 选 用 表		页 2
阳 台 联 门 窗 及 专 用 窗 选 用 表		页 3
用 料 规 格 断 面		页 4
外 平 开 窗 立 面		页 5
阳 台 联 门 窗 及 外 开 窗 立 面		页 6
外 开 带 纱 密 闭 钢 窗 节 点		页 7
外 开 带 纱 钢 窗 节 点		页 8
纱 门 扇 立 面 及 阳 台 门 节 点		页 9
钢 窗 铁 脚 安 装 详 图		页 10

1. 本图集适用一般民用建筑(有腐蚀性气体的建筑或房间不宜采用),有配合住宅或建筑标高高的需要。在原76J71图集的基础上,增设1400及2250毫米高的钢门窗。并改为某J71图集。类型以一致,纱为无。凡号采用GC,如需要所做法时可在代号下加一粗线(即GC),并在订货时提出要求。本图集一经批准使用,凡76J71图集即行作废。
2. 门窗编号以洞口300模数为基,前一数字代表宽度,后一数字代表高度,各表以300倍数为取,例45GC即为1200×1500的附纱窗。个别不合模数的洞口以其它数字代之。例40GC即为1200×1400附纱窗。
3. 为解决热轧钢窗料的供应不足,本图集特设计256及257两种空腹型管料,以供空腹料配窗生产用。五金配件均由钢窗厂配套供应。因某不另立五金表。阳台门一概不配装门框,安装时应在订货时提出。窗纱采用1吋16目铁纱,玻璃采用3毫米白片。
4. 本图集洞口缝隙以20毫米厚粉饰考虑,如工程的粉饰厚度超过20毫米时,求用人应在具体工程图中预留洞口缝隙。
5. 产品出厂一律涂防锈漆一道,表石油漆材料及颜色由采用人选定。
6. 安装钢窗铁脚的预埋件由采用人根据工程墙体材料,参照图注铁脚位置尺寸研究确定。
7. 有关加工制作及验收标准由钢窗厂另绘图纸及有关负责按标准规定执行。安装后的钢窗验收按建筑工程验收标准执行。
8. 成品搬运时须轻拿轻放,严禁重物相压及碰撞,或持柄棒穿入窗框内横托。如有变形,必须调直后才能进行安装。
9. 安装钢门窗时,先将木楔在四面阴角处或横竖边处垫起,使钢门窗框塞紧稳柱,找准横竖水平,固定铁脚后拔去木楔。

高度	600	900	1200	1500	1800	2100	2400	
600	 22GC左  23GC右	 32GC  33GC	 42GC  43GC	 52GC  53GC	 62GC  63GC	 72GC  73GC	 83GC	
900	 23GC左  24GC右	 34GC  35GC	 44GC  45GC	 54GC  55GC	 64GC  65GC	 74GC  75GC	 84GC  85GC	
1200	 24GC左  25GC右	 36GC  37GC	 46GC  47GC	 56GC  57GC	 66GC  67GC	 76GC  77GC	 86GC  87GC	
1400	 25GC左  26GC右	 38GC  39GC	 48GC  49GC	 58GC  59GC	 68GC  69GC	 78GC  79GC	 88GC  89GC	
1500	 26GC左  27GC右	 40GC  41GC	 50GC  51GC	 60GC  61GC	 70GC  71GC	 80GC  81GC	 90GC  91GC	
1800	 27GC左  28GC右	 42GC  43GC	 52GC  53GC	 62GC  63GC	 72GC  73GC	 82GC  83GC	 92GC  93GC	
2100		 44GC  45GC	 54GC  55GC	 64GC  65GC	 74GC  75GC	 84GC  85GC	 94GC  95GC	

注: 1. 本图为外开窗, 一般一玻一纱, 图示外立面, 加取消纱窗可在编号后加1号, 如56GC1即为单玻型。  
 2. 为配合住宅降低层高的设计需要, 增设1400高度系列的窗型。

洞口	1200	1500	1800	洞口	450	750	1050	1350
2100				1400				
	47NGC	57NGC	67NGC	1500	150GC左 150GC右	250GC左 250GC右	350GC	450GC
					155GC左 155GC右	255GC左 255GC右	355GC	
	<p>此部分窗为中小学教室专用窗，内开单玻无纱，上层玻璃装耳钩铁链，下层玻璃装高脚铁链。</p>			<p>此部分窗为阳台门的组合窗。在设计中如详架尺寸因结构要求而影响选用架型置时，可选用以上型号窗。但考虑到工业化生产的要求，在正常情况下应优先选用型号为宜。</p>				
洞口	750	1200	1500	1800	2100			
2250								
	022GM左 022GM右	422GY左 422GY右	522GY左 522GY右	622GY左 622GY右	722GY左 722GY右			
2400								
	08GM左 08GM右	48GY左 48GY右	58GY左 58GY右	68GY左 68GY右	78GY左 78GY右			
			850	900				

注：阳台门为外敞内纱，图示为立面。左右方向编号以门的左右位置为准，门在左侧时左至右侧为左开，在右侧为右开。窗台通用料 1980 阳台联门窗及专用窗选用表 页 3 页 71

	<p>251    <math>\phi 43</math>    1.18kg/M</p>		<p>252    <math>\phi 39</math>    1.07kg/M</p>		<p>253    <math>\phi 39</math>    1.07kg/M</p>		<p>254    <math>\phi 39</math>    1.07kg/M</p>
	<p>255    <math>\phi 43</math>    1.18kg/M</p>		<p>256    <math>\phi 34</math>    1.01kg/M</p>		<p>257    <math>\phi 34</math>    1.01kg/M</p>		<p>5019    <math>\phi 66</math>    3.11kg/M</p>
	<p>2517    1.11kg/M</p>		<p>2519    1.09kg/M</p>	<p>冷弯钢板流水 条可代替 3218型钢材</p>	<p>3218    0.83kg/M</p>		<p>5019    <math>\phi 66</math>    3.11kg/M</p>
<p>2517    1.11kg/M    2519    1.09kg/M    3218    0.83kg/M    5019    <math>\phi 66</math>    3.11kg/M</p> <p>为联合空预器制粉系统的规格配套生产，特设计256及257两种空管规格，以代替2517及2519两种热轧圆管料，凡有高热地管机的加工单位，可参照本设计试制生产，试制过程中如发现任何问题可与本流联系。</p> <p>通用图 1980</p> <p>密封橡胶条    香山县人工厂产制</p> <p>用料规格断面</p>							

洞口	600	900	1200	1500	1800	2100	2400
600	 22GC± 22GC#	 32GC	 42GC	 52GC	 62GC	 72GC	 82GC
900	 23GC± 23GC#	 33GC	 43GC	 53GC	 63GC	 73GC	 83GC
1200	 24GC± 24GC#	 34GC	 44GC	 54GC	 64GC	 74GC	 84GC
1400	 20GC± 20GC#	 30GC	 40GC	 50GC	 60GC	 70GC	 80GC
1500	 25GC± 25GC#	 35GC	 45GC	 55GC	 65GC	 75GC	 85GC
1800	 26GC± 26GC#	 36GC	 46GC	 56GC	 66GC	 76GC	 86GC

注: 1. 洞口宽度900及1200的对开窗, 均安装平开铰链, 其它一律安装断桥铰链。  
2. 洞口高度1400及1500的窗扇, 应安装连杆双把手为宜。

通用图  
1980

外平开窗立面

页次 | 5  
系列 J71



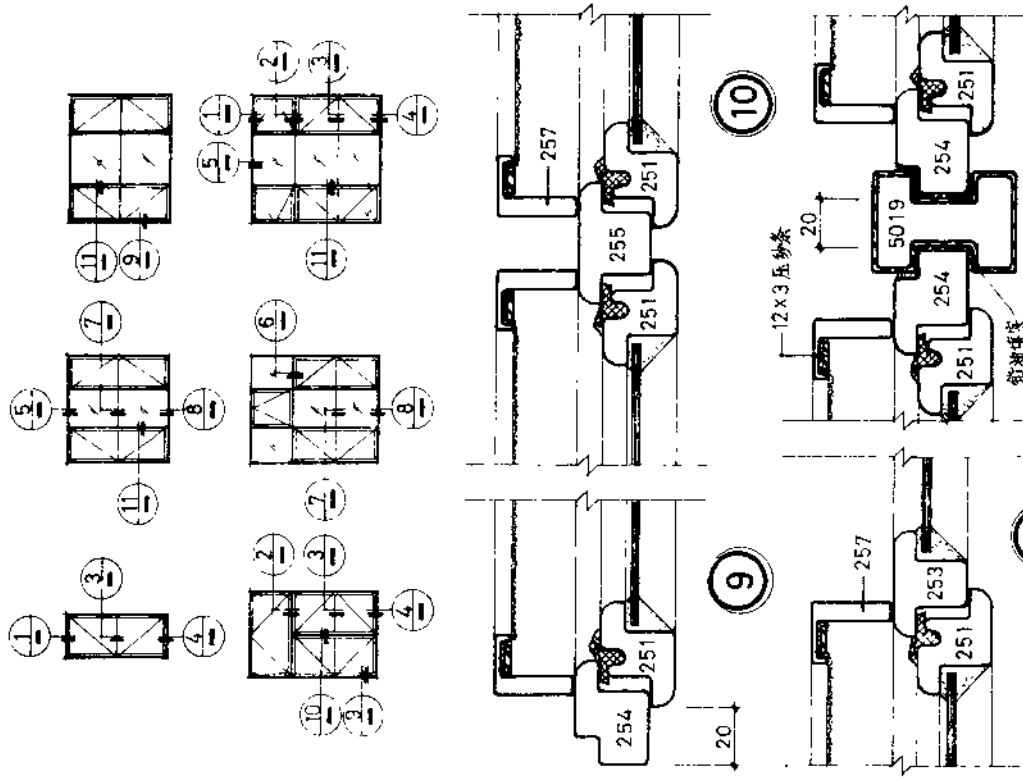

钢窗组合节点

注 本图节点砂窗料及玻璃分格条采用新设计管型。如加工厂尚未生产此种管型，可改用 2519 及 2517 两种热轧钢圆料生产。

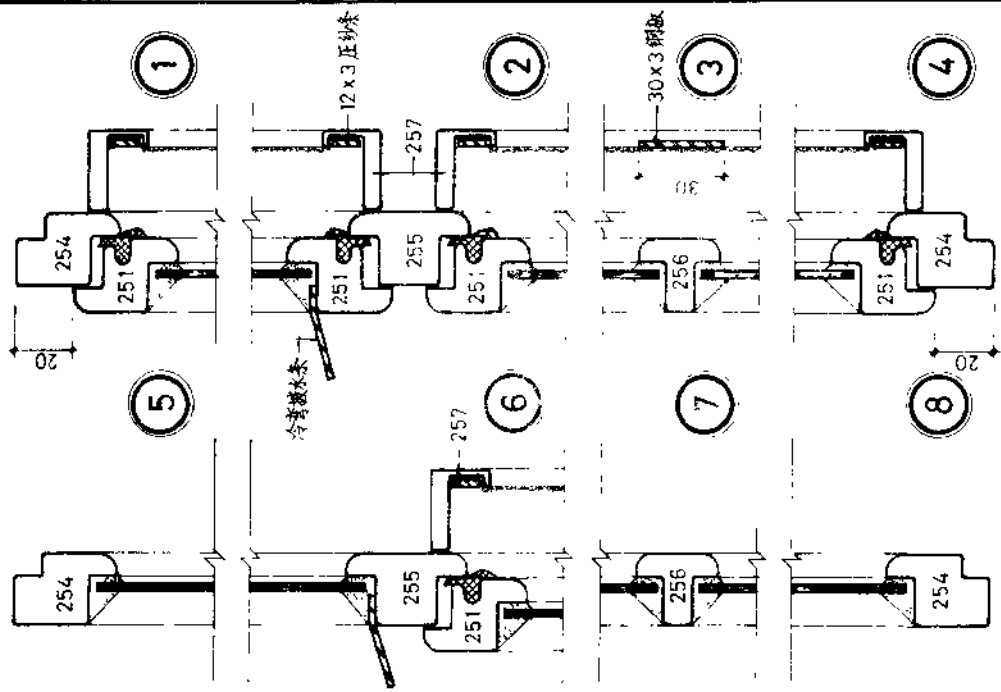

通用图 1980 外开带纱密闭窗节点



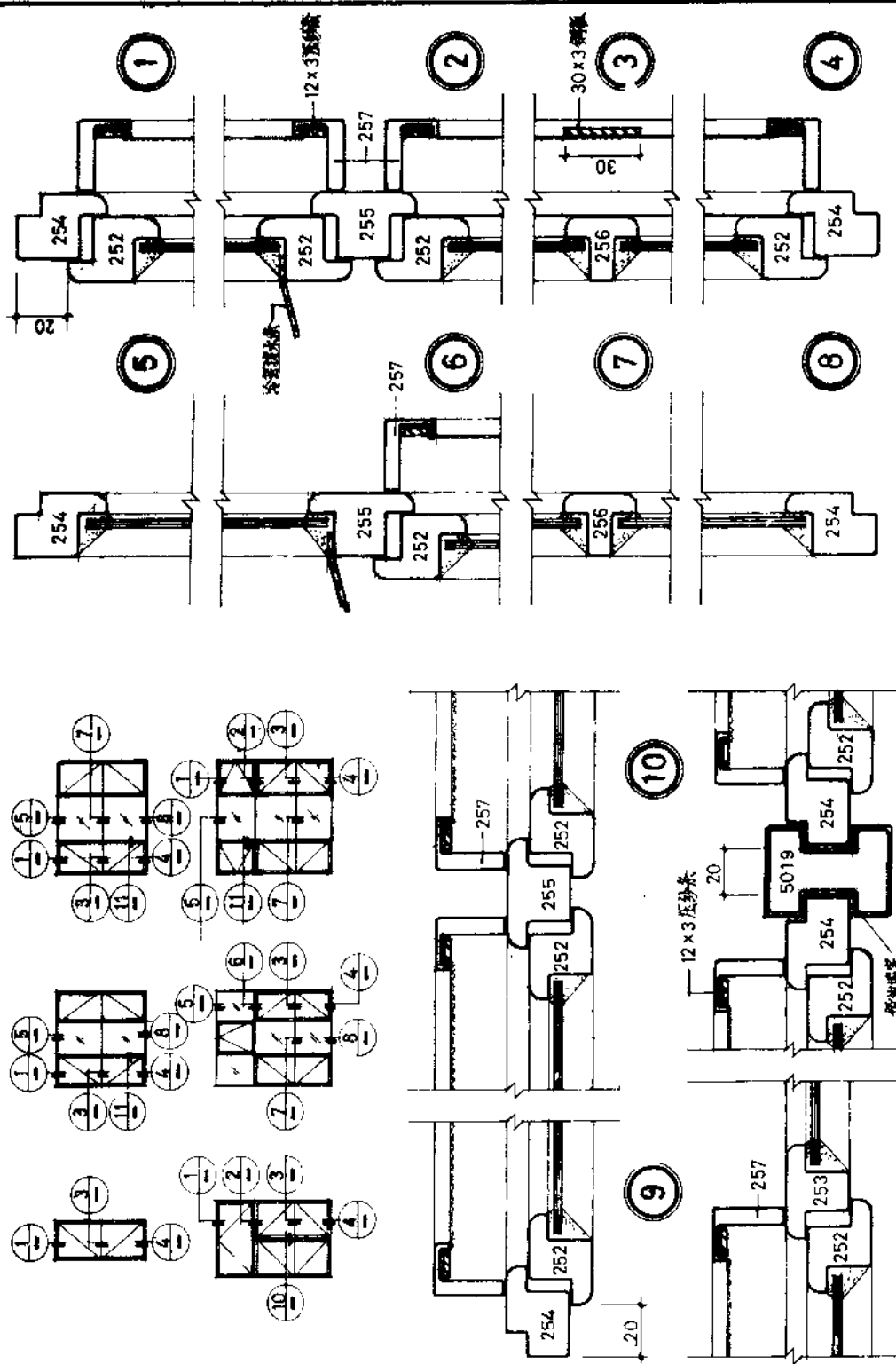

钢窗组合节点

注：本图节点纱窗材料及玻璃分格表均采用新设计管型，如加工厂家未生产此种管型前，可用2519及2517两种热轧钢管生产。

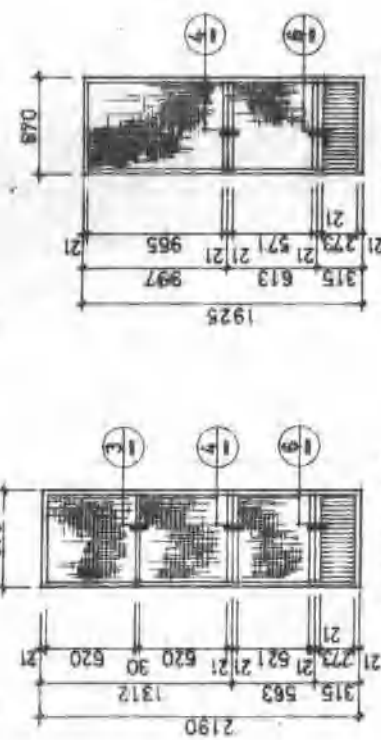
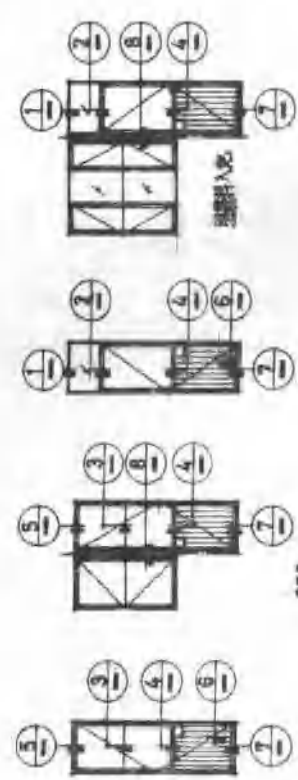
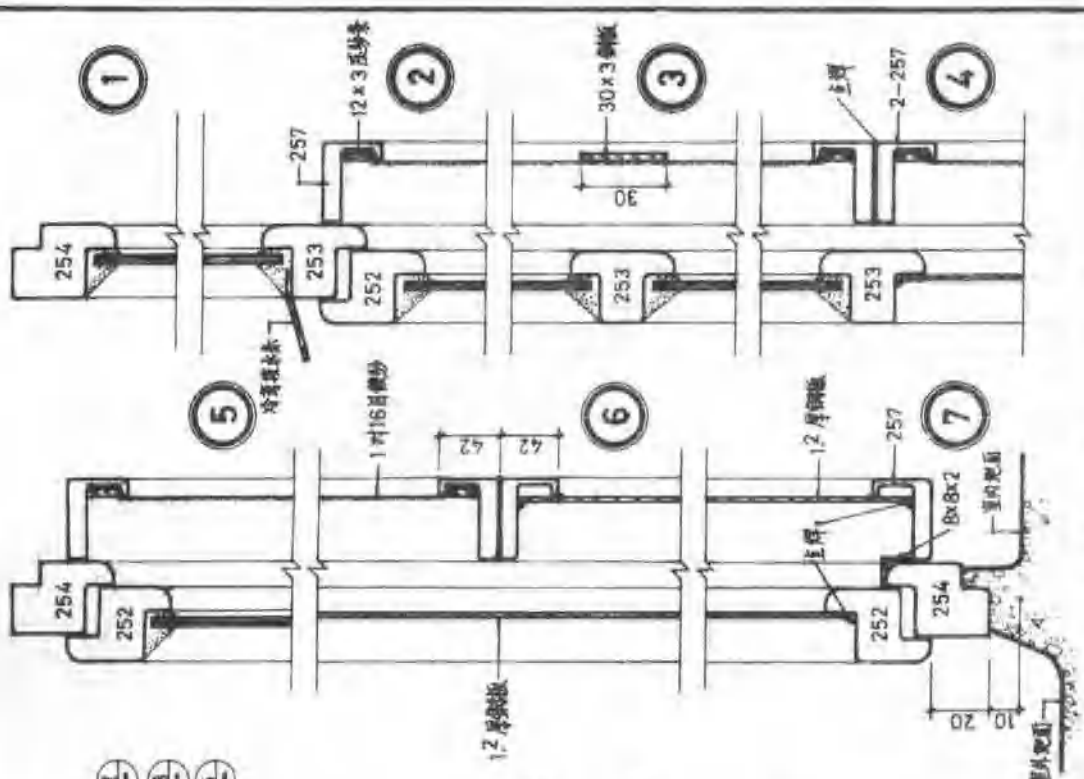

09GM纱打窗

022GM纱打窗

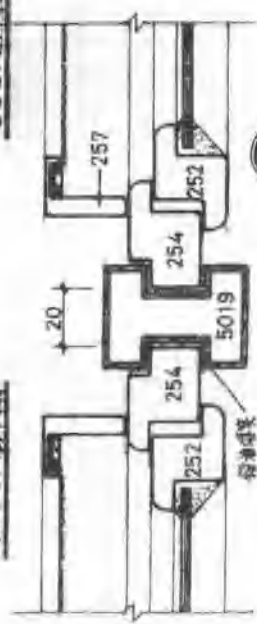

组装节点 ⑧

注：阳台门一般不配窗打窗，如需用窗打窗，可在工程图中注明并在加工时提出，窗框有窗打窗法，可将252并换成251材料，但也要在加工时提出。

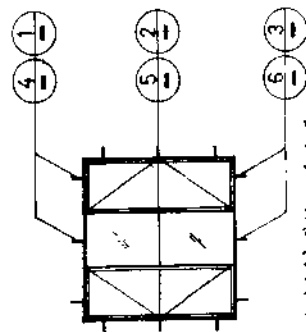

窗框铁脚位置示意图

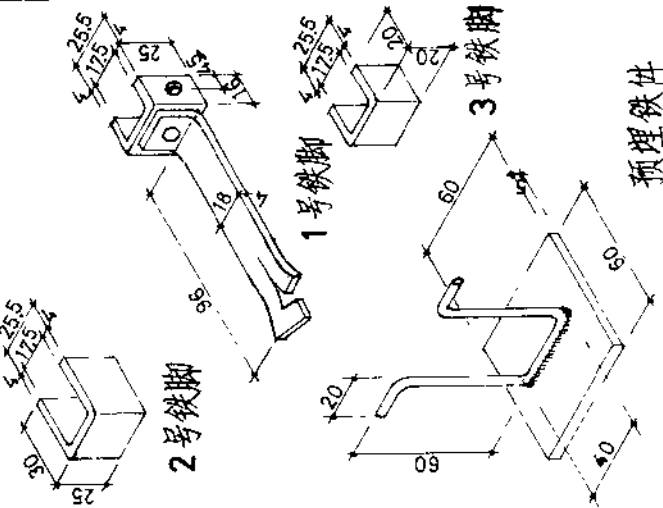

预埋铁件

铁脚详图

注：1. 物面材料的厚度如超过20毫米时，预埋件具体工程图另作处理。  
2. 铁脚位置及数量详见立面图，预埋铁件由施工单位备料预埋。

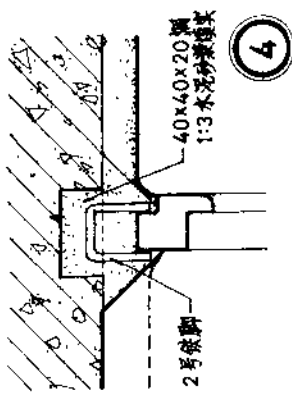

2号铁脚

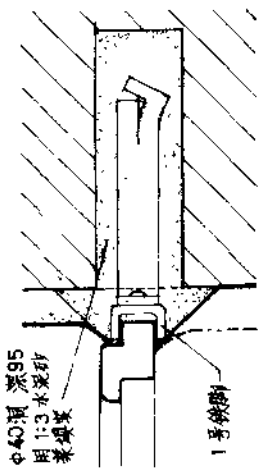

1号铁脚

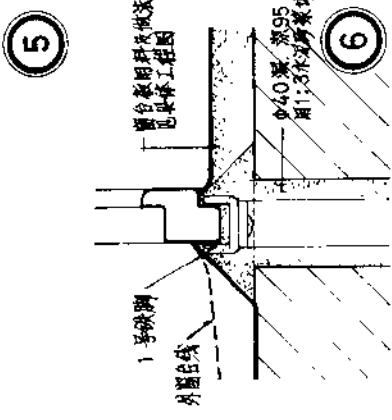

1号铁脚

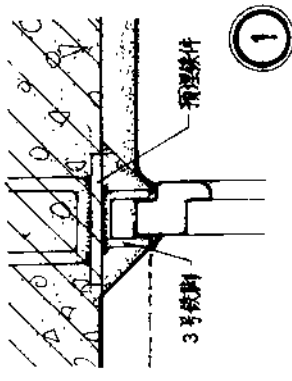

3号铁脚

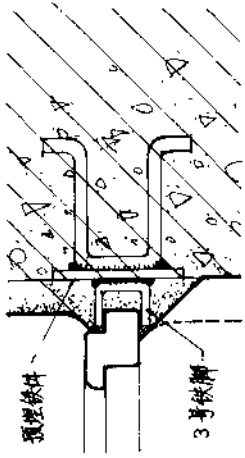

3号铁脚

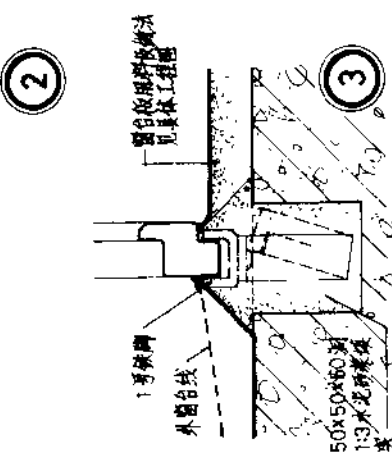

1号铁脚

留洞安装详图

预埋铁件安装详图

通用图 1980  
窗框铁脚安装详图 页次 10  
页次 10