

# 世界童装

1.716.1

中国轻工业出版社

(京)新登字 169 号

世界童装

陆琦 主编

本书编写组 编著

责任编辑 任鹤

\*

农村读物出版社 出版

北京南华印刷厂 印刷

各地新华书店 经销

\*

787×1092 毫米 1/16 9.75 印张

1992年6月第1版 1992年6月北京第1次印刷

印数: 1—8400

ISBN7-5048-1497-6/TS·45 定价: 8.05 元

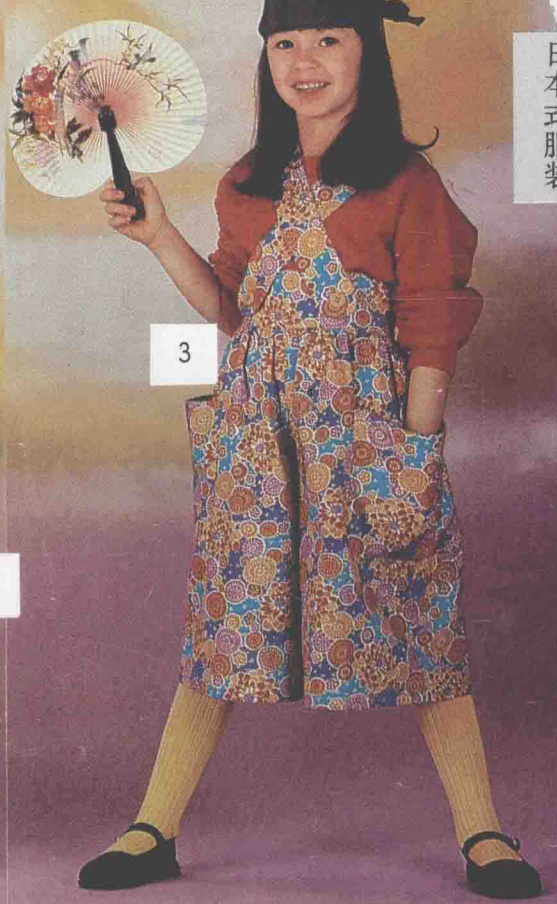

活泼  
方便  
实用

1

单位：厘米

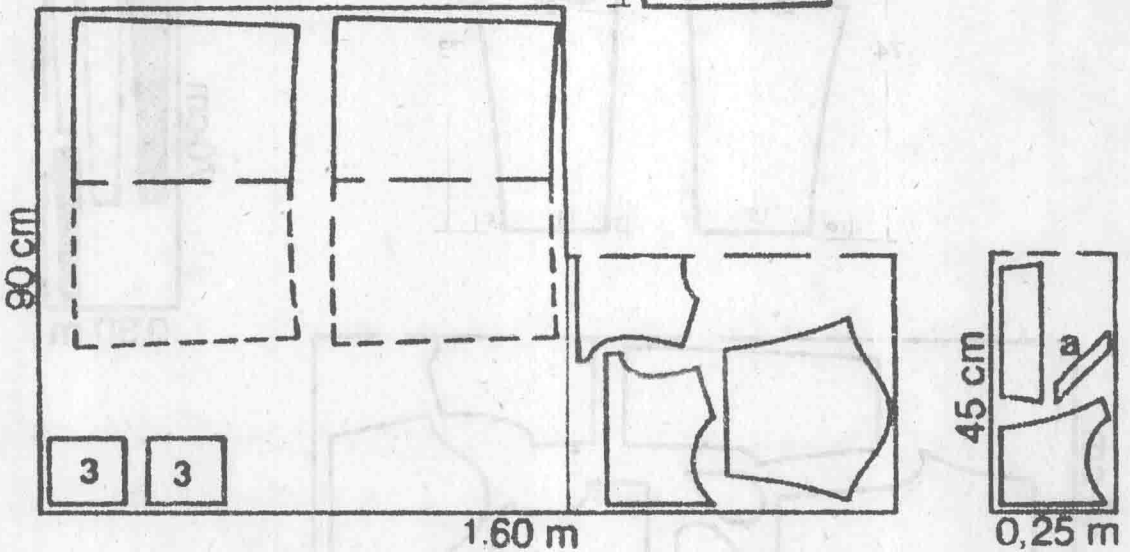
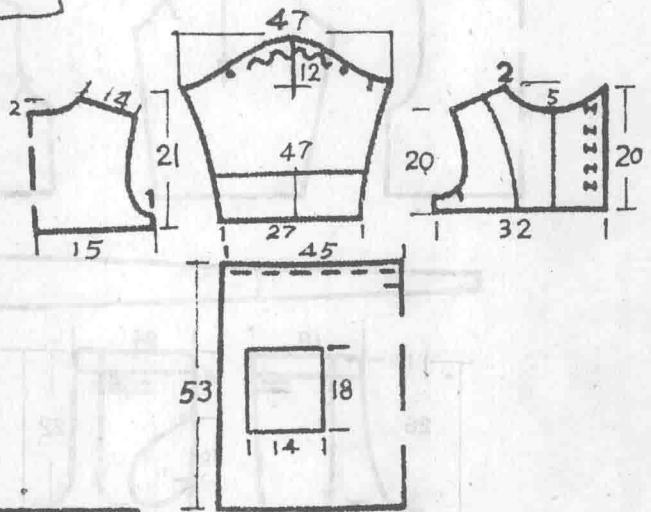
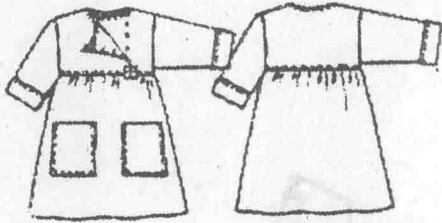

2-1

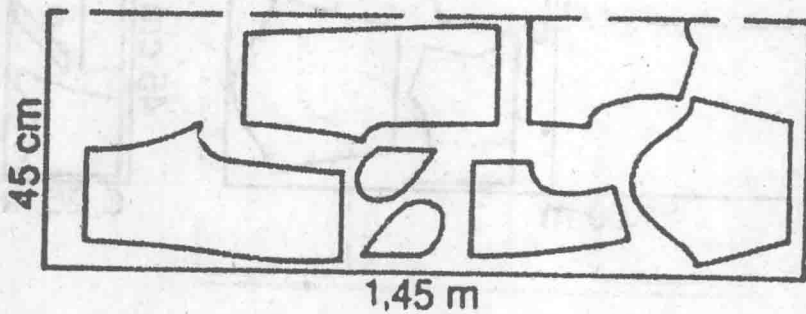
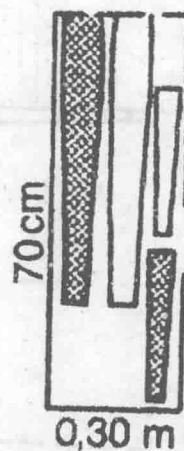
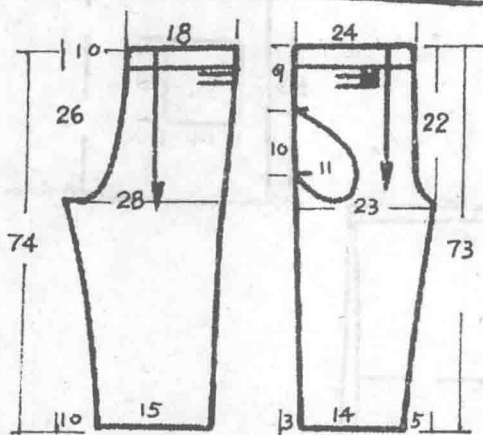
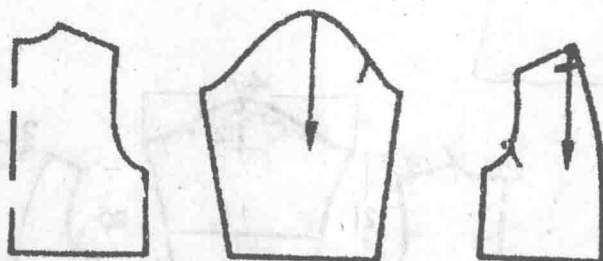
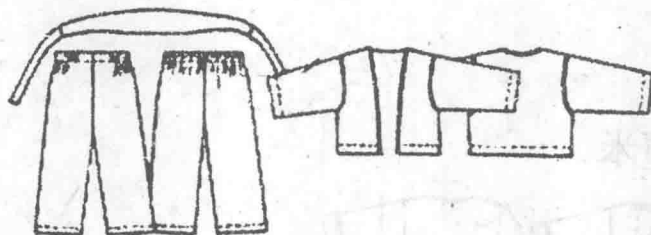

2—2

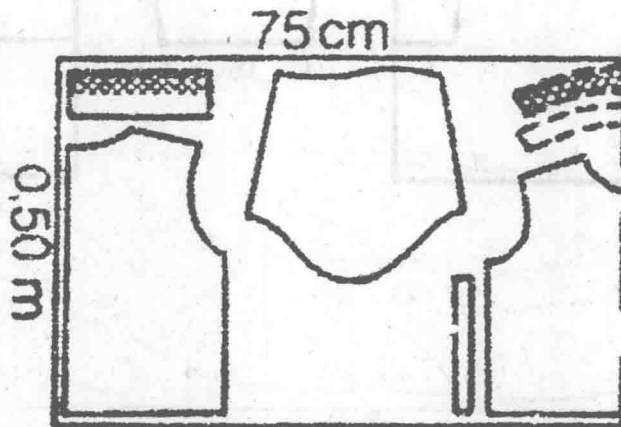
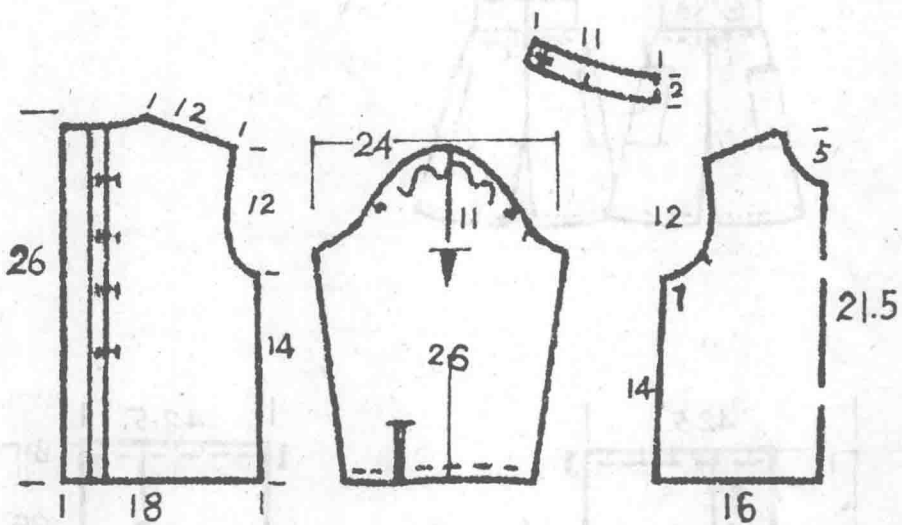
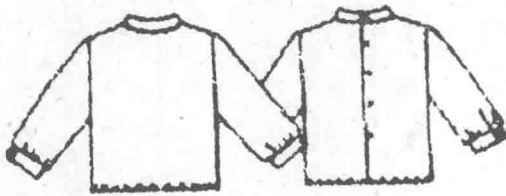

3

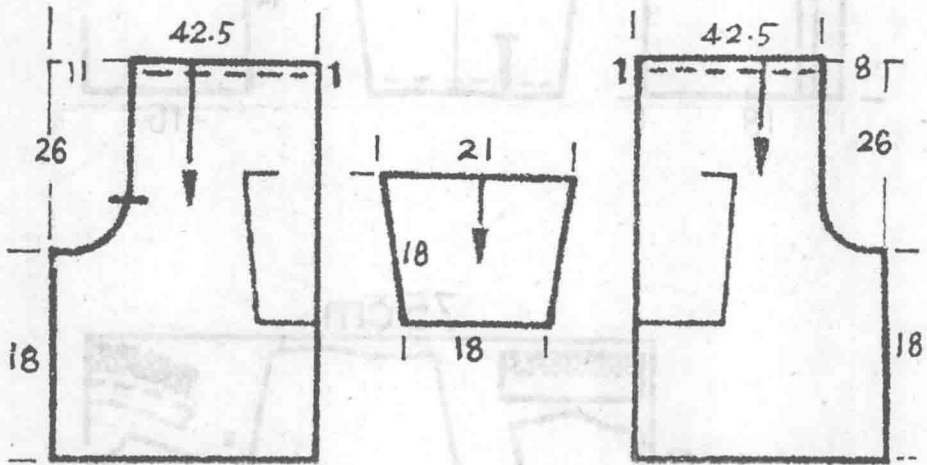
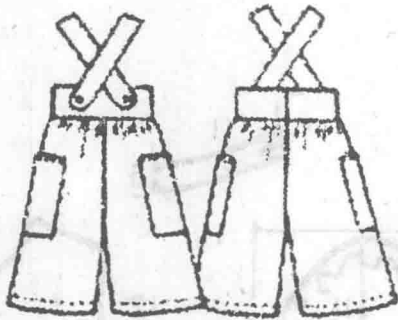

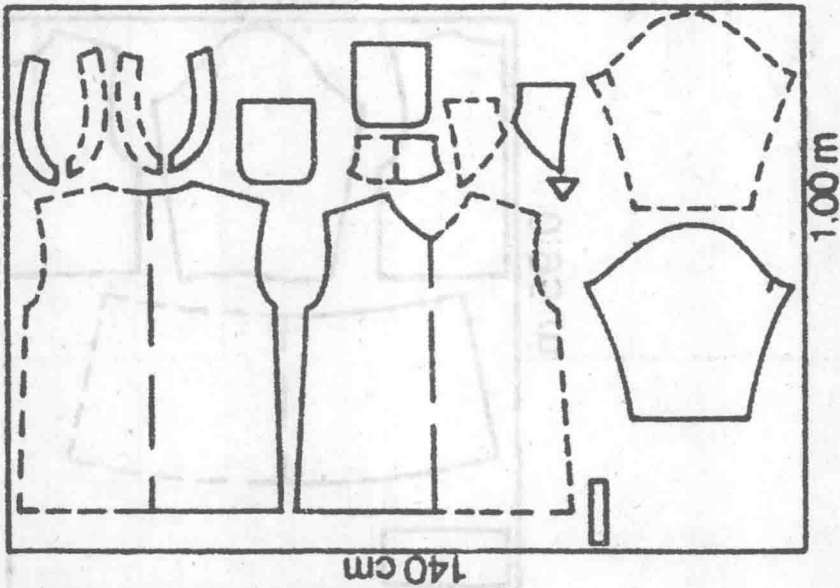
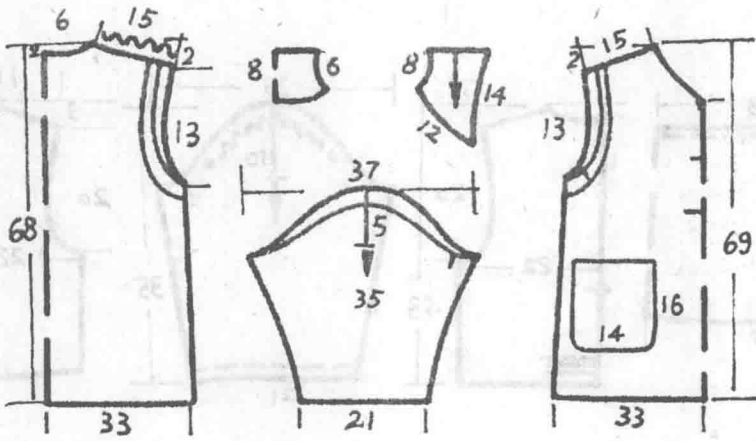
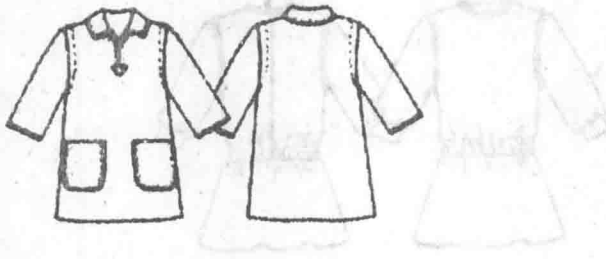



5

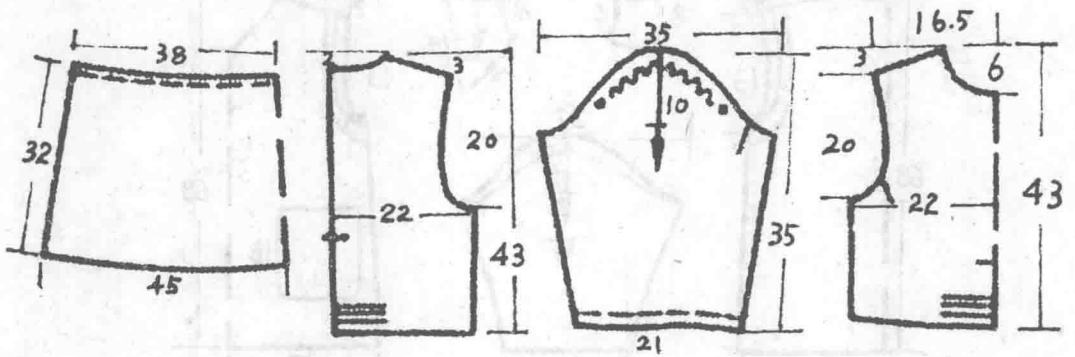
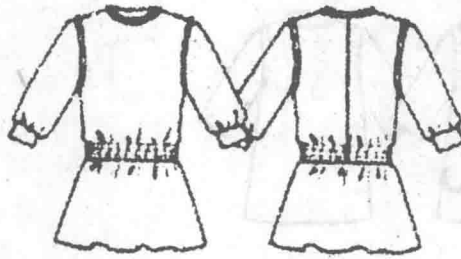

75 cm

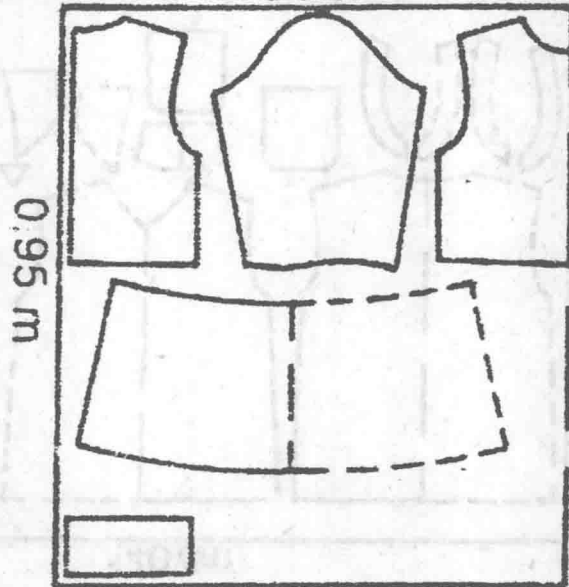

6

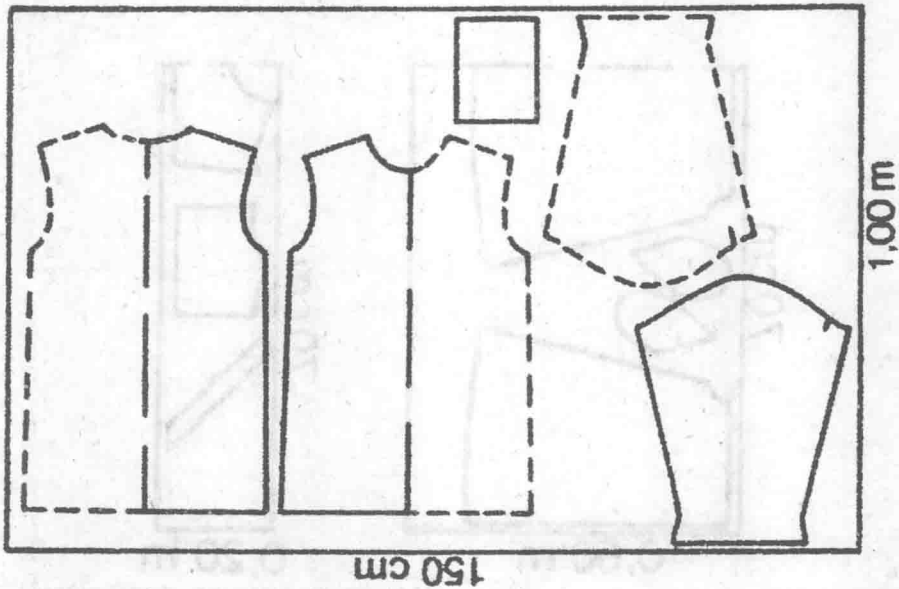
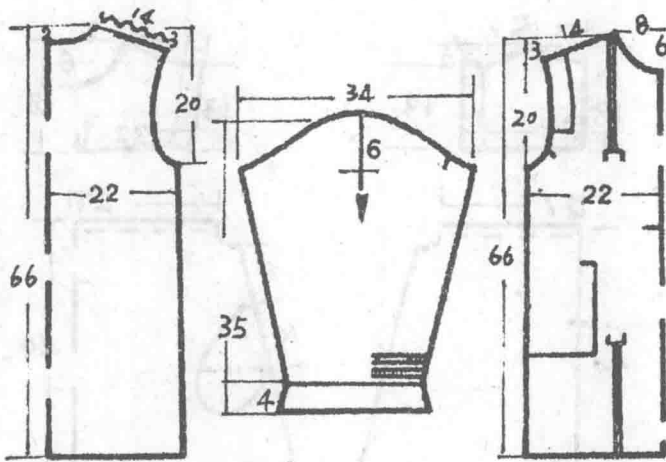
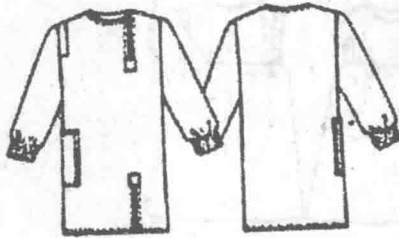

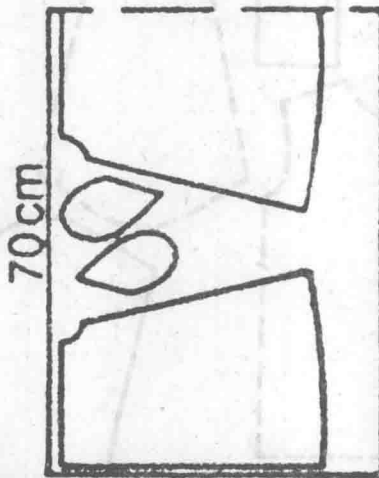
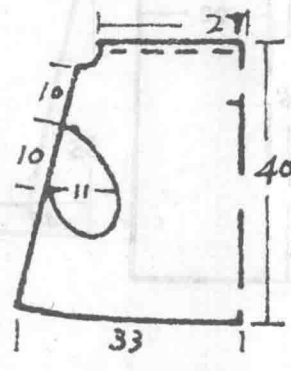
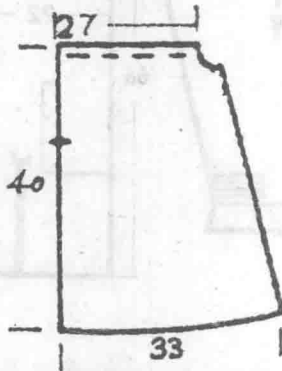
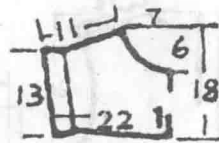
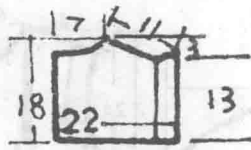
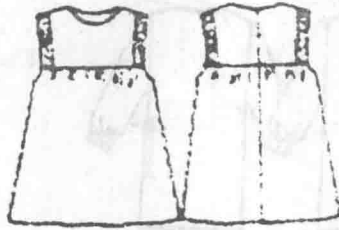

0,50 m



0,20 m

8

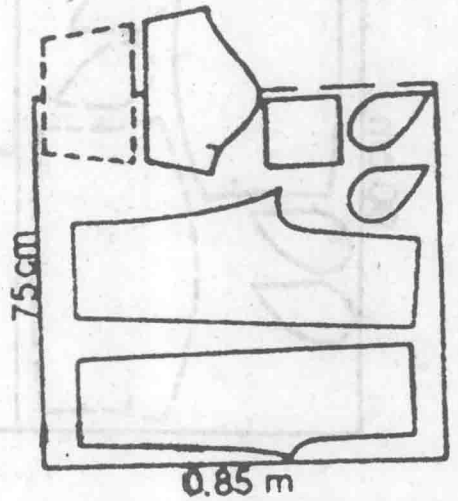
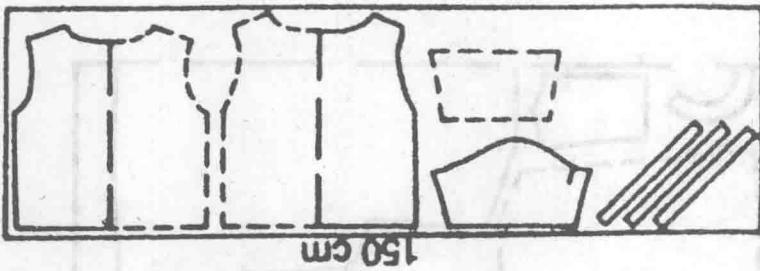
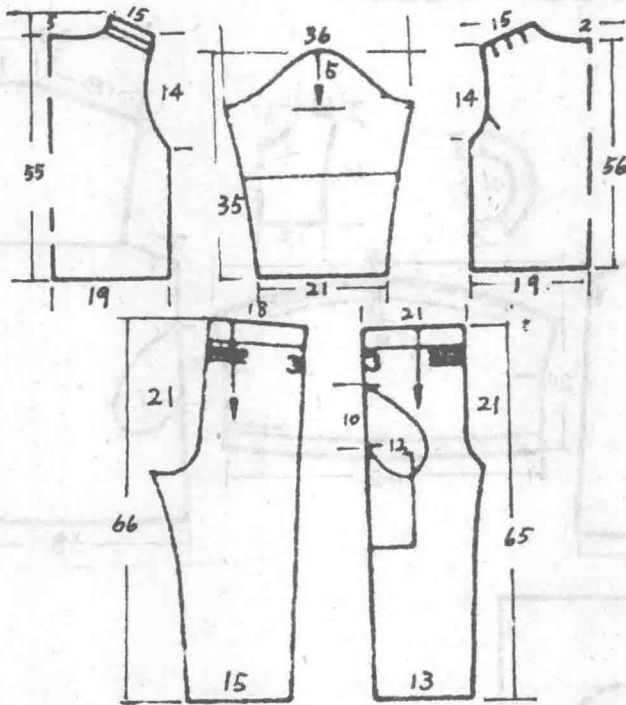
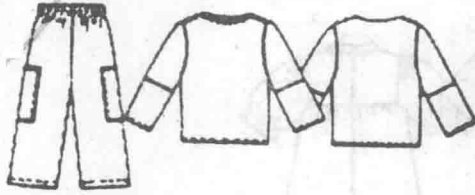

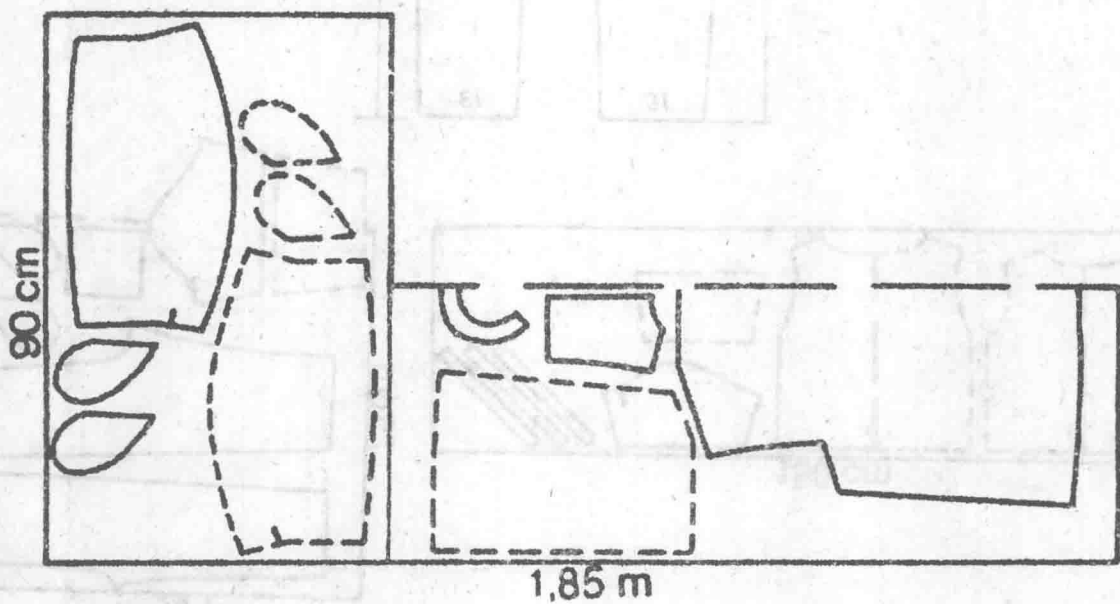
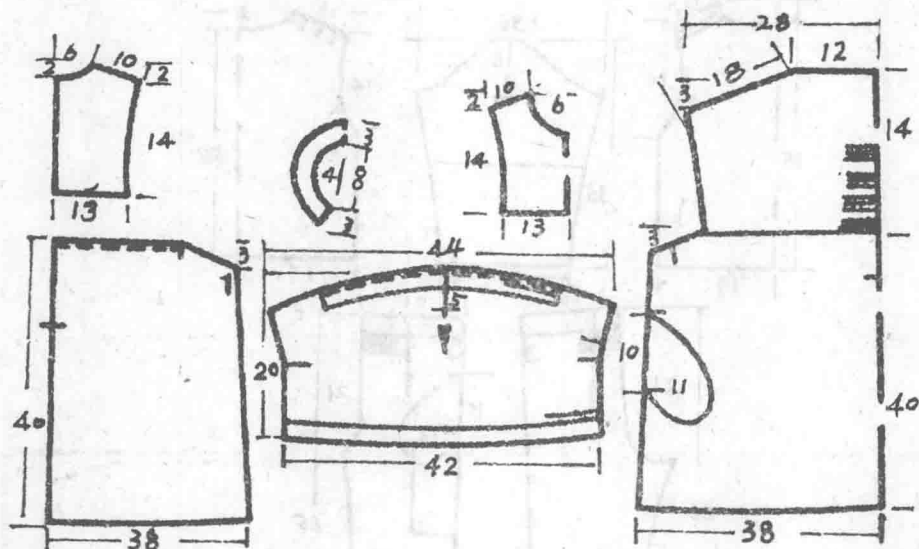
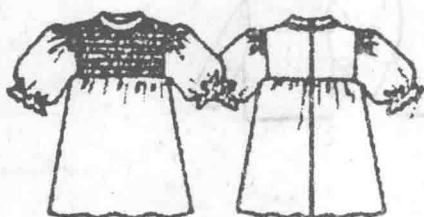

10

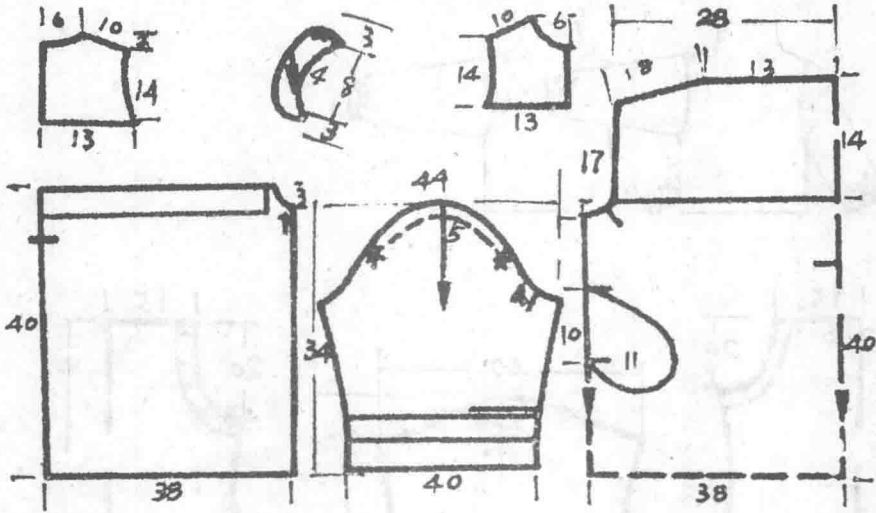
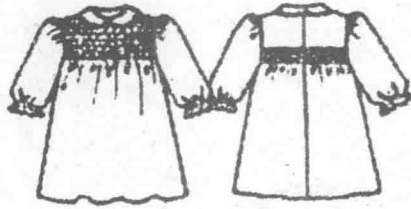

150 cm

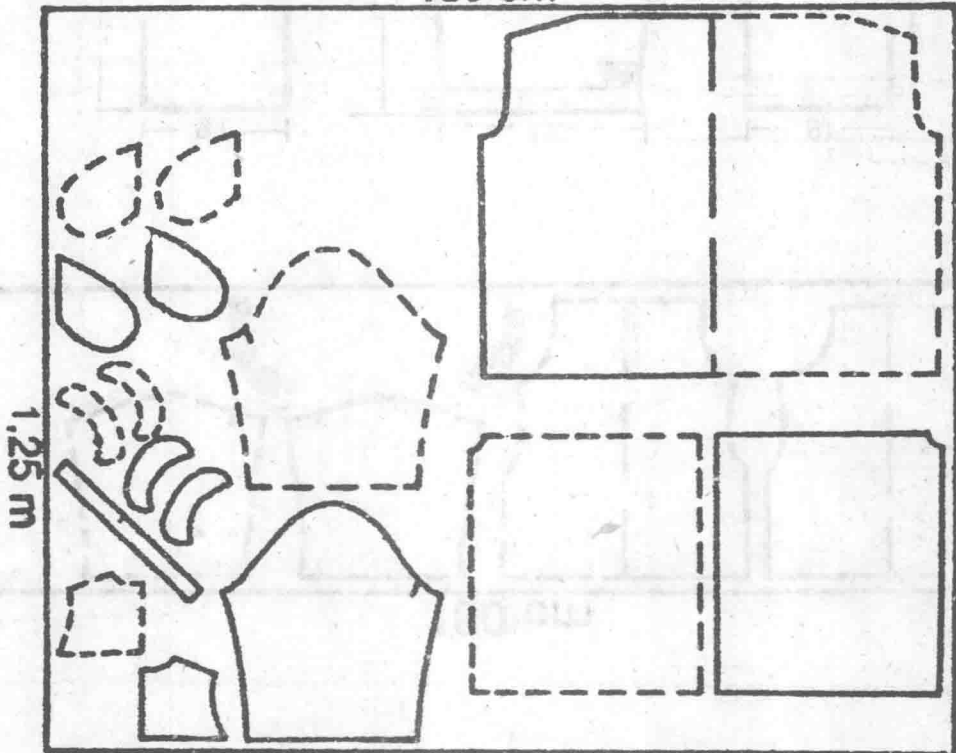

11-1

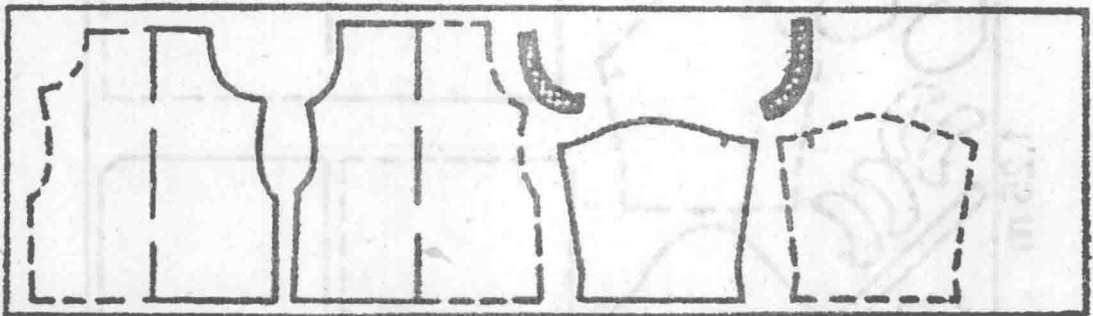
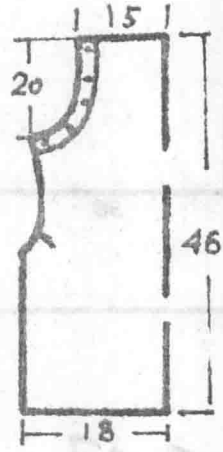
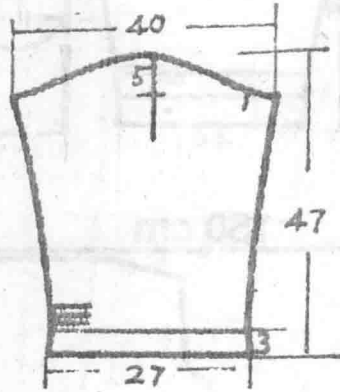
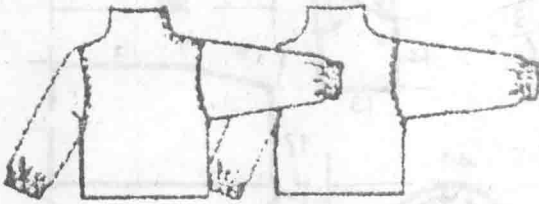
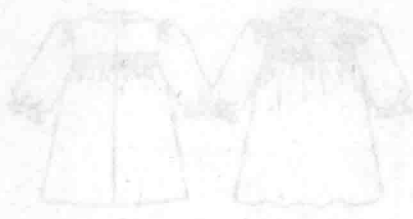

160 cm

0,45 m

11-2

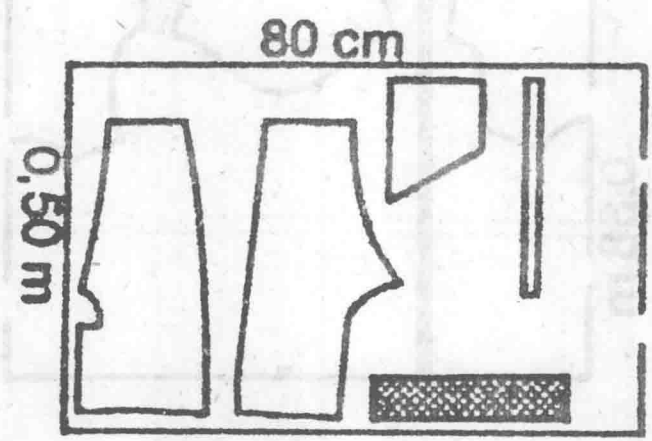
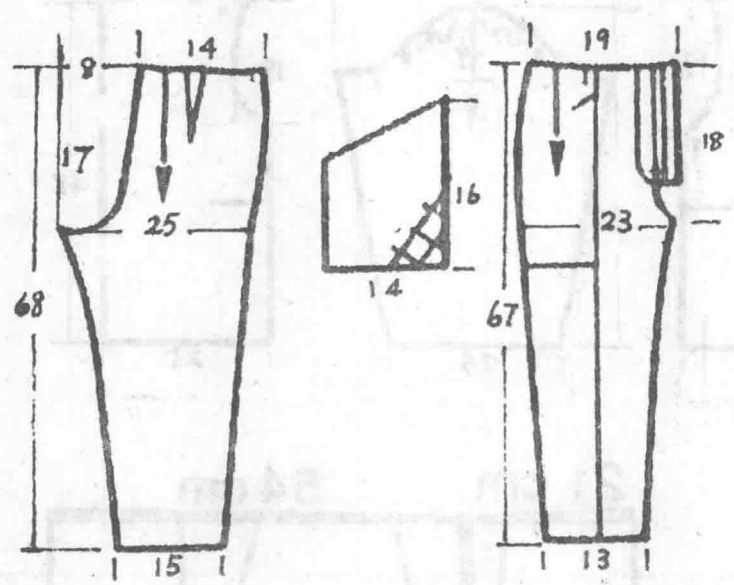
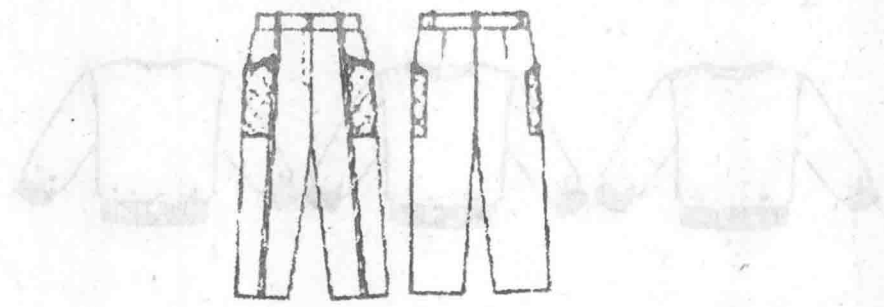



12-1

