

262

简易时装快速裁剪丛书

# 裙子·背心

杨红明

李莉

祈峥

编

纺织工业出版社

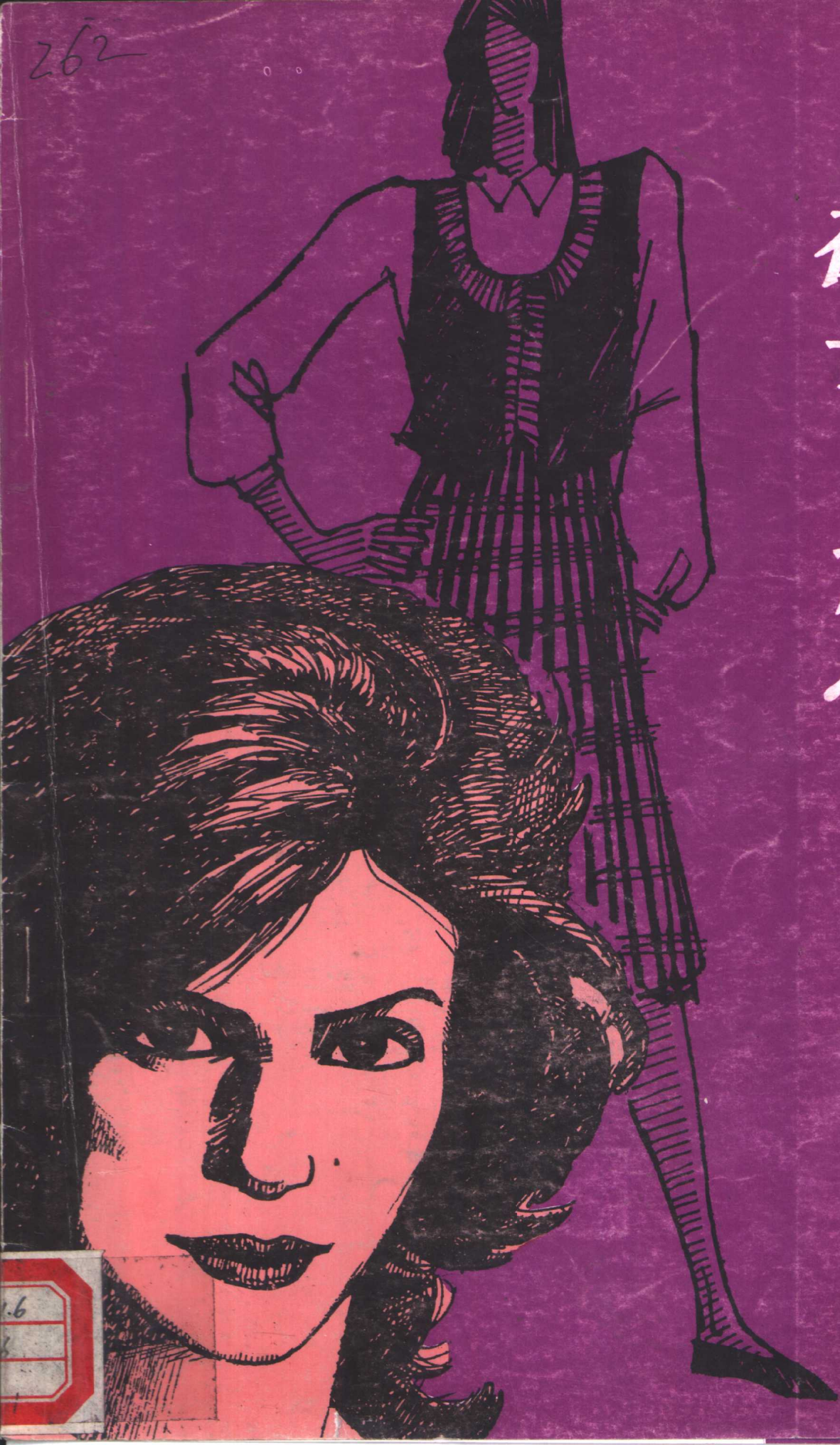

简易时装快速裁剪丛书

# 裙子背心

杨红明 李莉 祈峥 编

纺织工业出版社

## 内 容 提 要

本书介绍了女性必备的裙子26款，背心30款。有长裙、窄裙、斜裙、迷你裙及适合各种年龄妇女穿着的长短背心。每款均配有简单的裁剪图及效果图。

本书提供的款式实用大方，易裁易做，可供广大社会消费者及服装爱好者阅读。

简易时装快速裁剪丛书

裙子 背心

杨江明 李莉 祈峥 编

纺织工业出版社出版

(北京东长安街12号)

纺织工业出版社印刷厂印刷

新华书店北京发行所发行

各地新华书店经售

787×1092毫米 1/16 印张：4 字数：91千字

1990年4月 第一版第一次印刷

印数：1—14,000 定价：2.25元

ISBN 7-5064-0458-3/T S · 0450

## 写在前面

服装设计的灵魂是设计观念，它的功底往往体现在服装造型上。近年来，服装设计师的设计观念发生了很大变化，从层层叠叠、累累赘赘地追求时髦转向以简练造型为主的现代艺术，这不仅给人们带来了新的视觉形象，也开拓了服装成衣化的道路。







随着时代的变迁，妇女职业结构发生了根本变化，女性的着装也在不断更替。19世纪末，由于美国妇女走向社会，简便舒适的女套裙相继而生。如今，城市现代化的发展日新月异，人们的生活节奏在加快，舒适简便的服装倍受妇女青睐。从近两年来国际流行服装趋势和国内服装流行趋势看，简练造型是服装设计中的突出代表。简练中求新颖、质朴中求高雅的简洁服装已成为女性理想的着装，而希望自己能裁制服装更是妇女的迫切愿望。只需花费微不足道的功夫，便可做成一套优雅别致的流行服装，这是本丛书的最大优点。

参加本套丛书编写的还有杨晓光、白经纬等同志。

编者

1989年10月

## 制图符号说明

	轮廓线
	折叠线
	基本线
	尺寸界线
	缩褶线
	缝松紧线

本书裁剪尺寸除标有毛份尺寸外，均为净尺寸，单位为厘米（cm）。

## 目 录

款式新颖的筒裙·····	( 1 )
线条明朗的筒裙·····	( 2 )
舒适、转动自如的宴会便裙·····	( 3 )
典雅美观的夏季短裙·····	( 4 )
直筒短裙·····	( 5 )
热情、大方的四片裙·····	( 6 )
迷离粗犷的紧身窄裙·····	( 7 )
具有牛仔风格的开口窄裙·····	( 8 )
直筒窄裙·····	( 9 )
富有运动员气质的假日便裙·····	( 10 )
线条流畅的斜裙·····	( 11 )
简洁明快的斜裙·····	( 12 )
大方的两节长裙·····	( 13 )
洒脱高雅的长裙·····	( 14 )
豪放、潇洒的长裙·····	( 15 )
罗曼蒂克的长裙·····	( 16 )
具有鲜明个性的长裙·····	( 17 )
宽松裙·····	( 18 )
雍容华贵的鱼尾裙·····	( 19 )
清秀洒脱的四片太阳裙·····	( 20 )
漂亮的荷叶裙·····	( 21 )
迷你裙·····	( 22 )
便于制作的双层裙·····	( 23 )
朴素、大方的吊带学生裙·····	( 24 )
潇洒的宽松裙裤·····	( 25 )
喇叭裙·····	( 26 )
悬垂领背心·····	( 27 )
具有绅士风度的背心·····	( 28 )
具有男士风格的圆摆背心·····	( 29 )
新颖的背心·····	( 30 )
轻快的V型底摆的背心·····	( 31 )
连袖式翻领小背心·····	( 32 )

# 款式新颖的筒裙

使你更加成熟、高雅

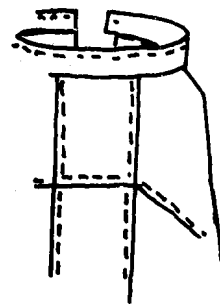
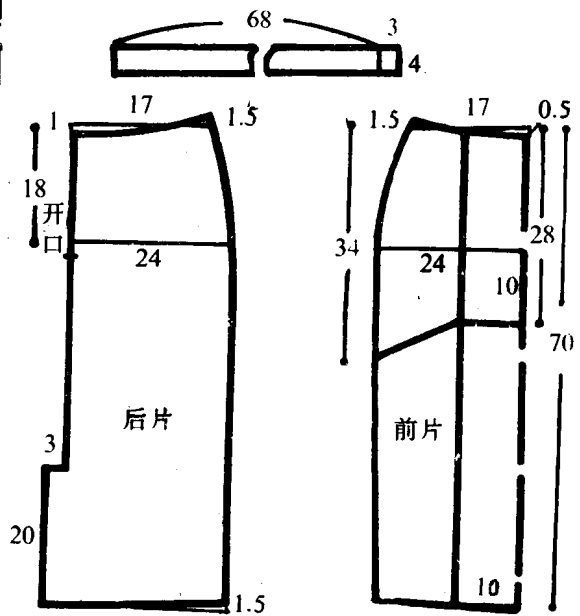
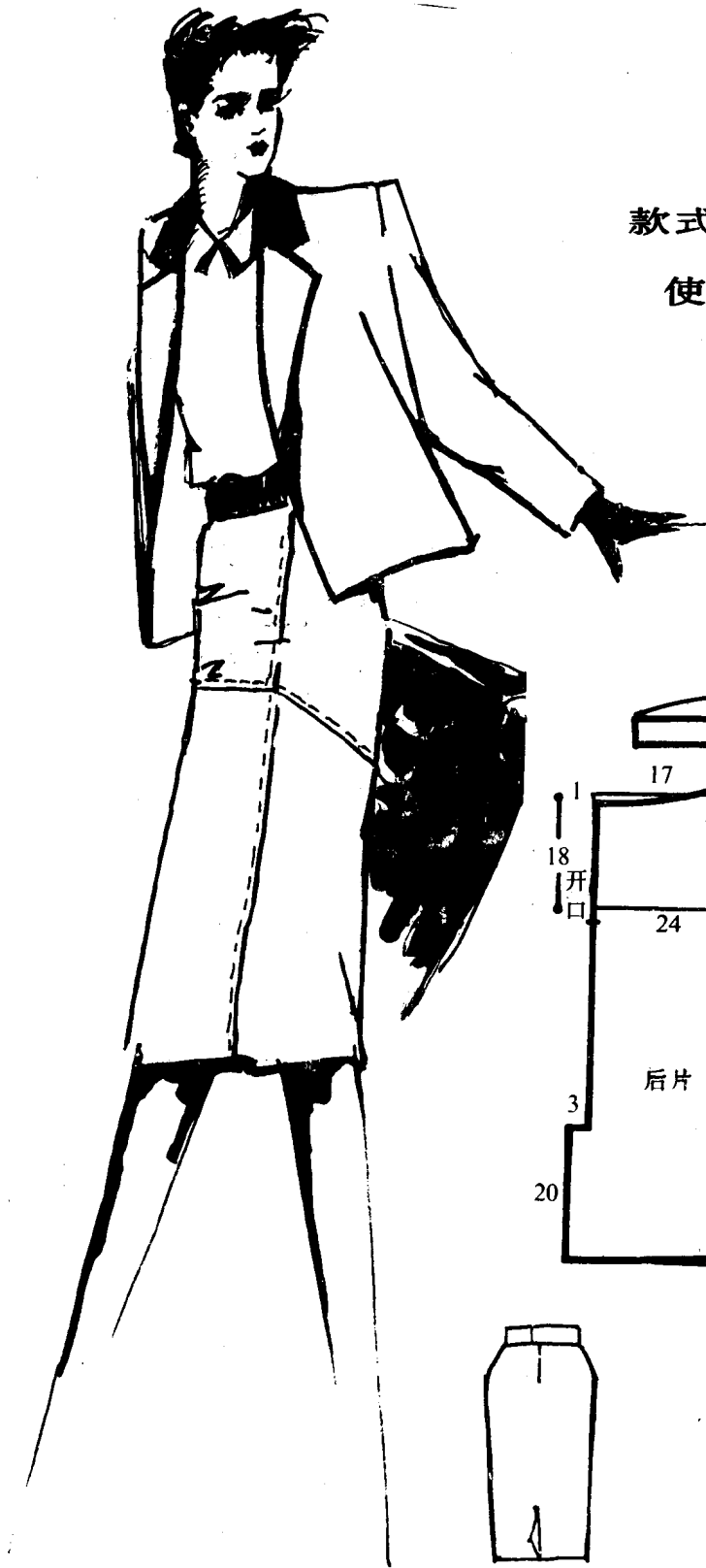

# 线条明朗的筒裙

展现出女性自然潇洒的魅力

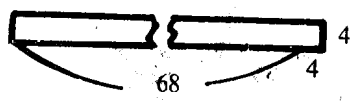
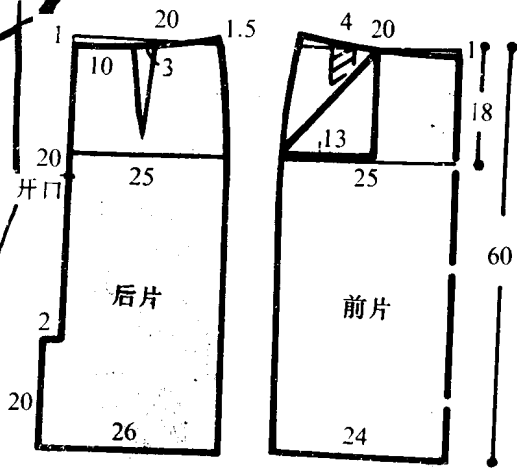
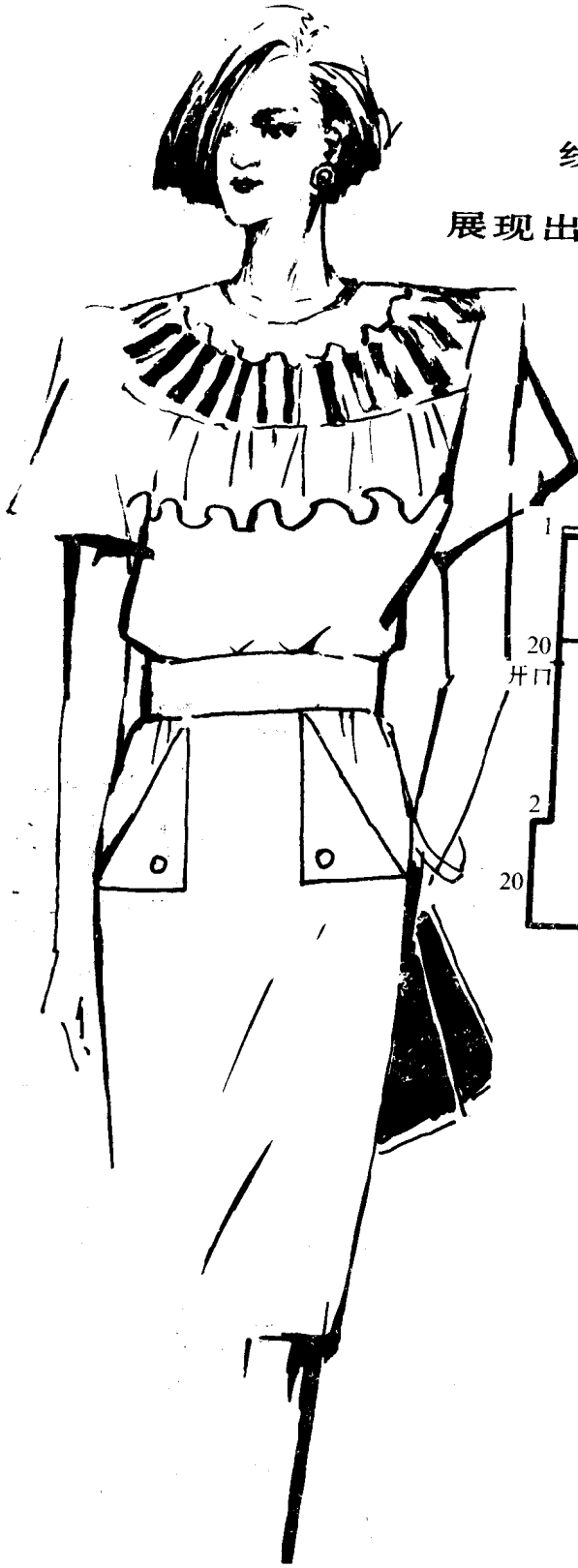





舒适、转动自如的宴会便裙

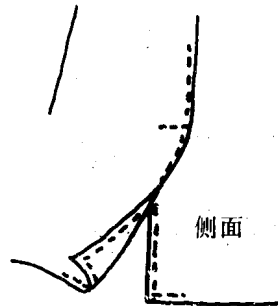
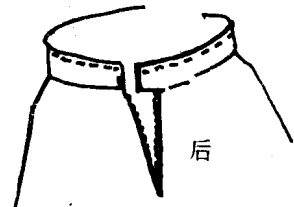
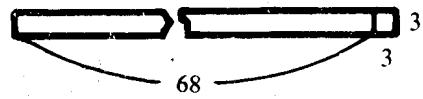
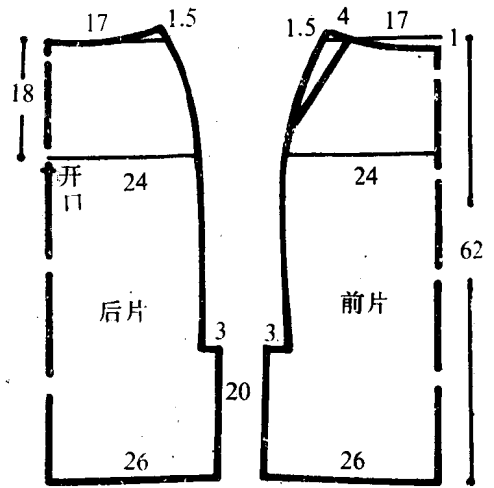

典雅美观的夏季短裙令你  
小巧玲珑

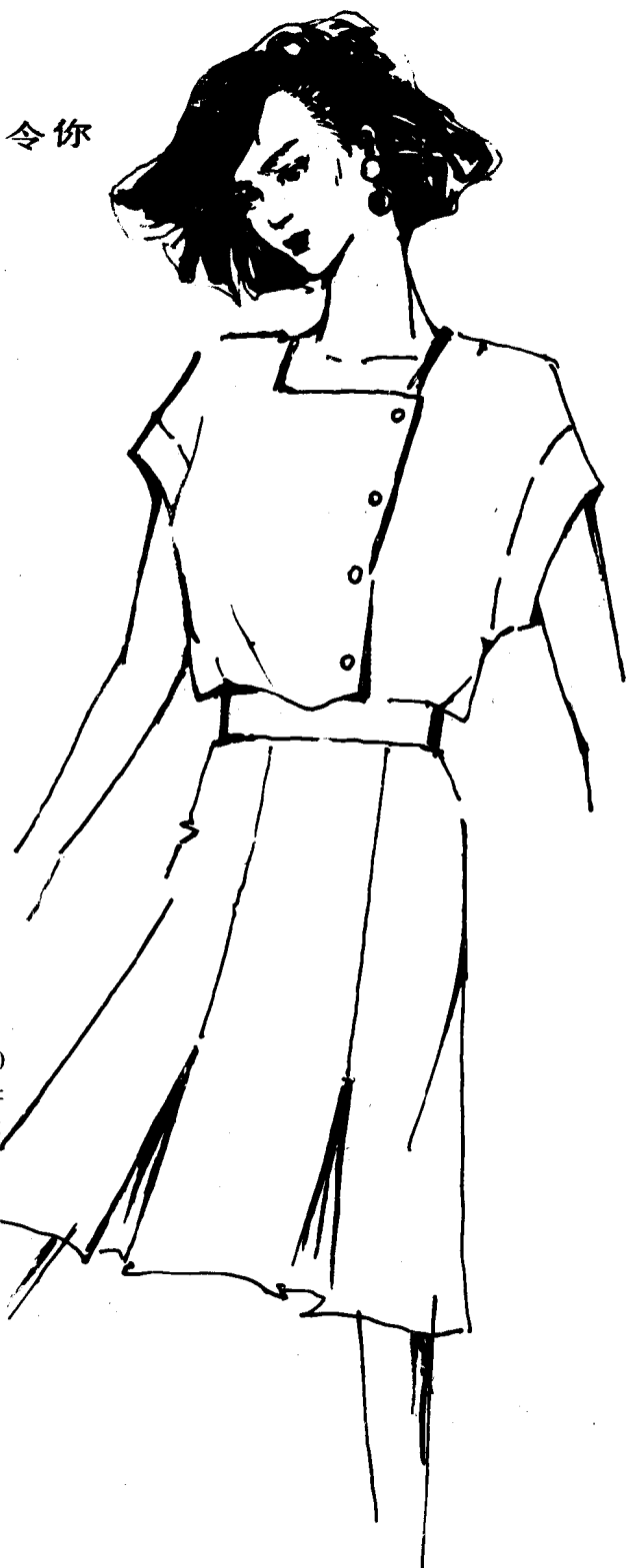
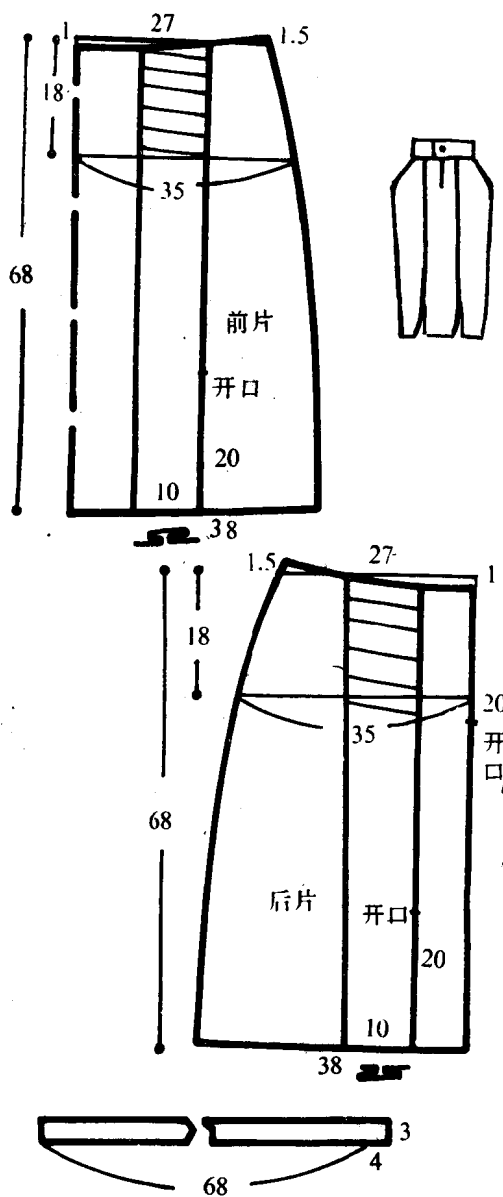

直筒短裙带给你温柔、  
典雅的气质

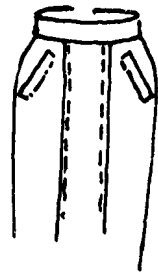
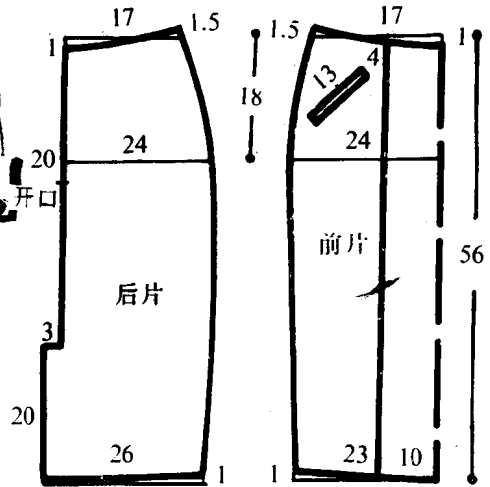

热情、大方的四片裙  
使你更富有魅力

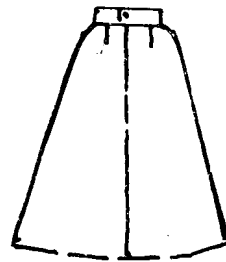
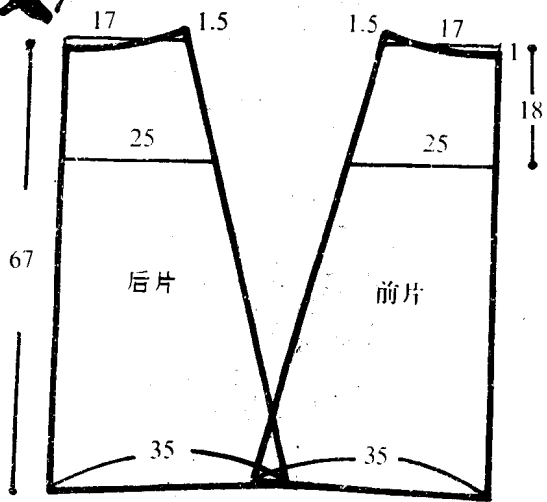
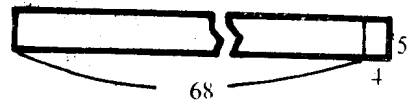
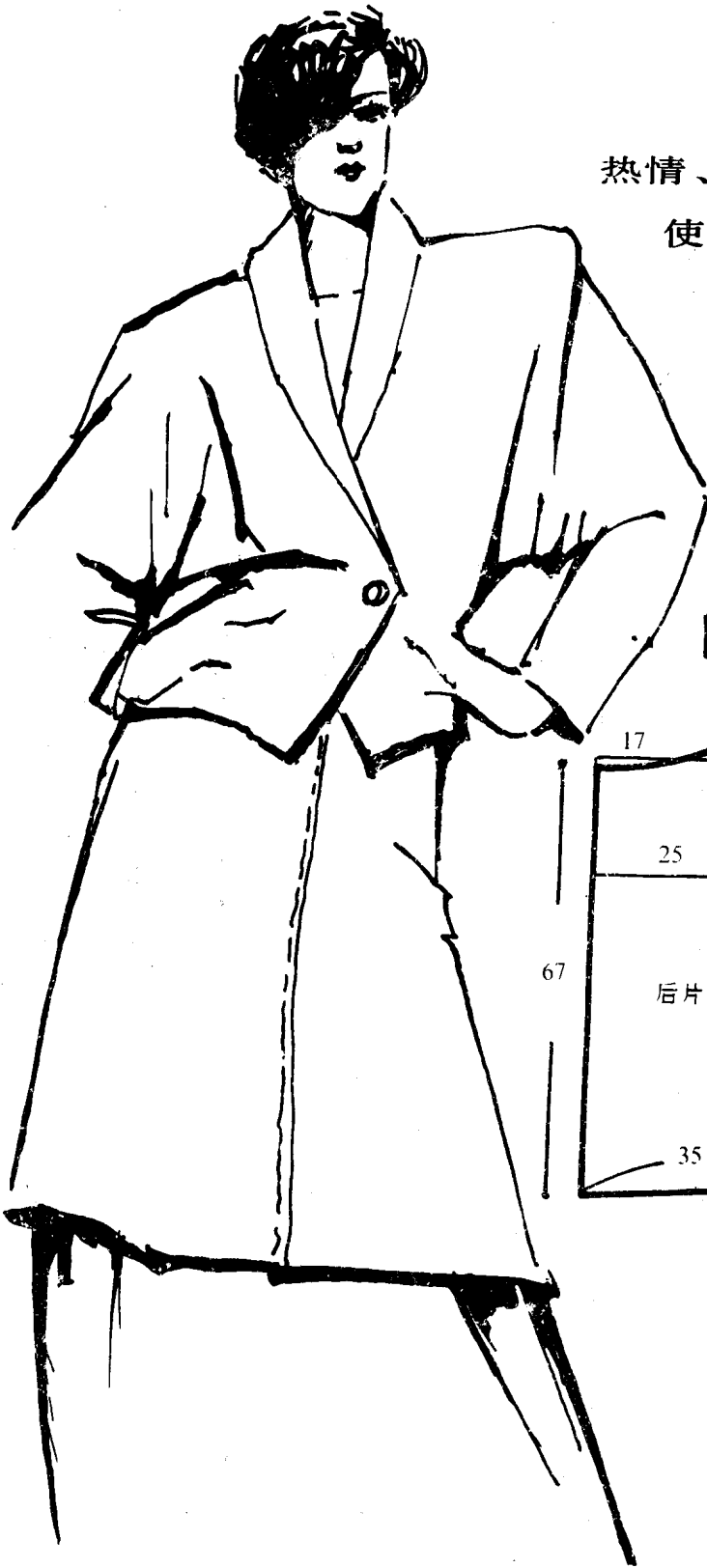

迷离粗犷的紧身窄裙  
令你风度翩翩

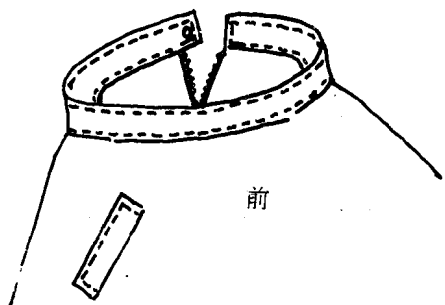
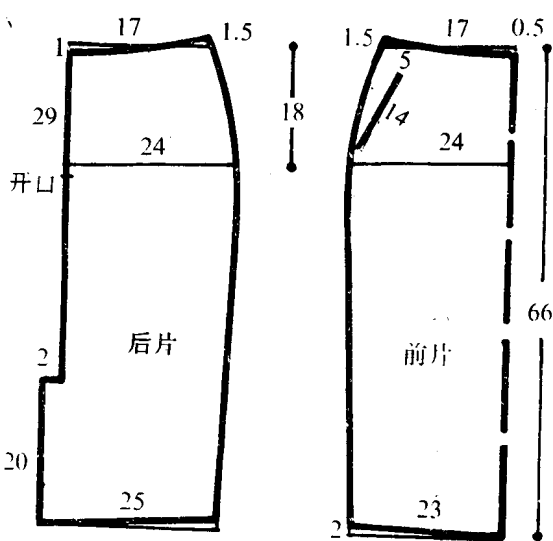
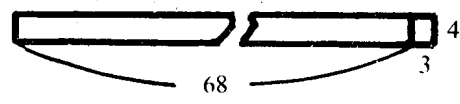
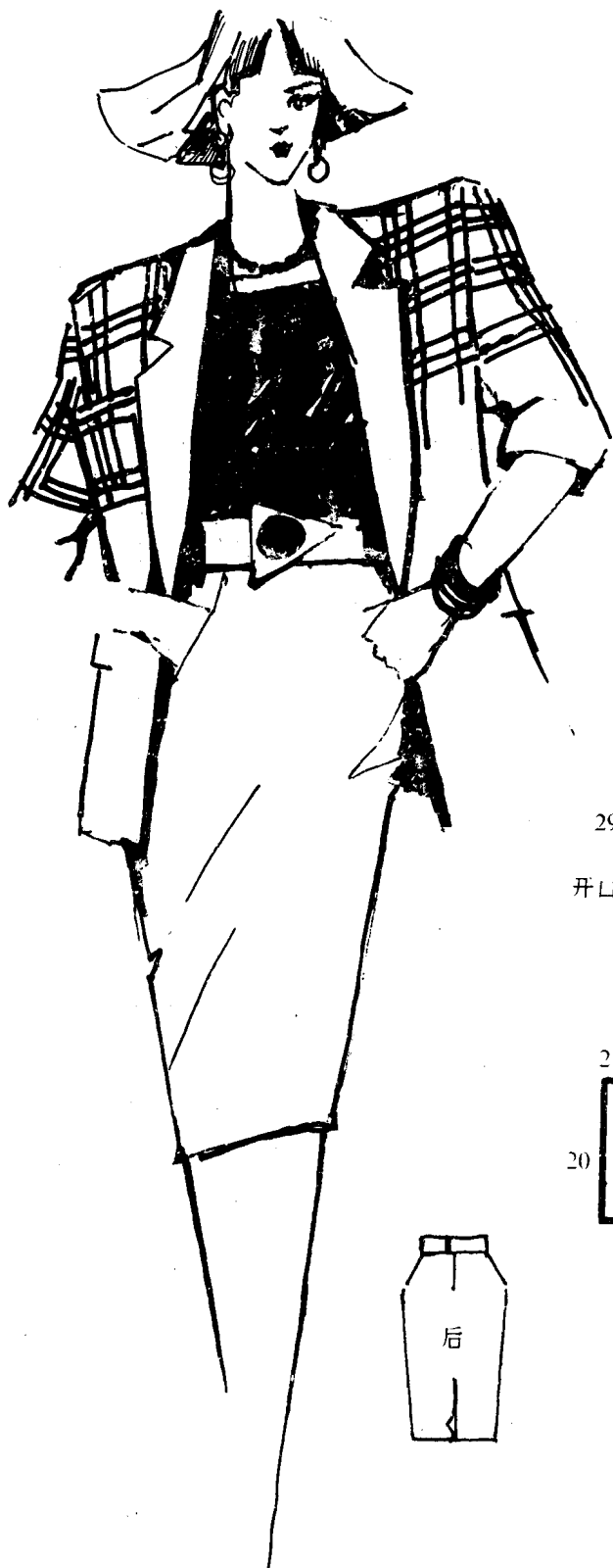

具有牛仔风格的开口窄裙

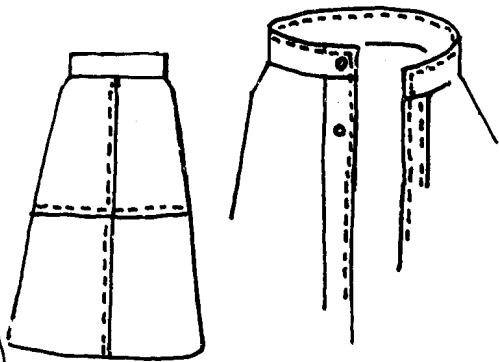
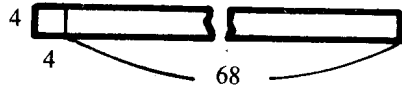
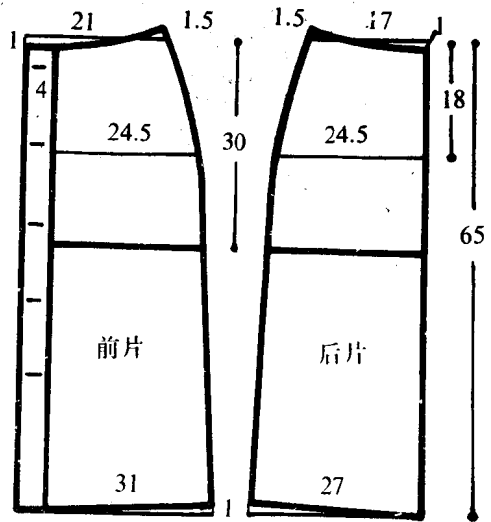
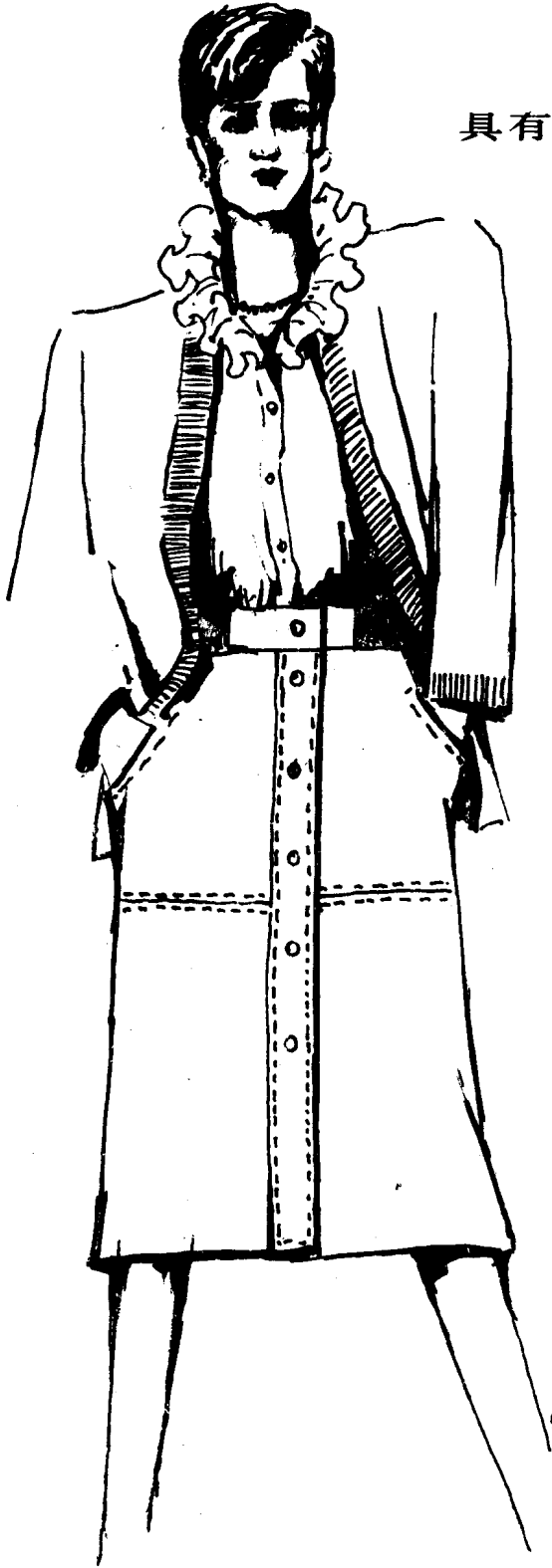

直筒窄裙，

给你带来绰约风姿

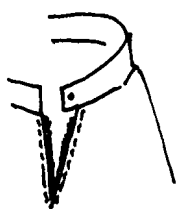
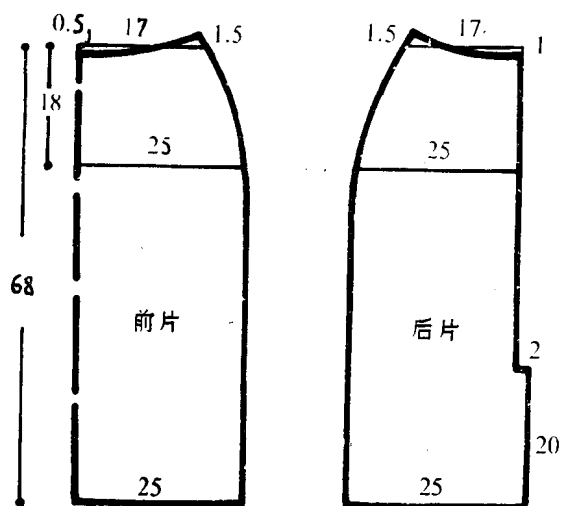
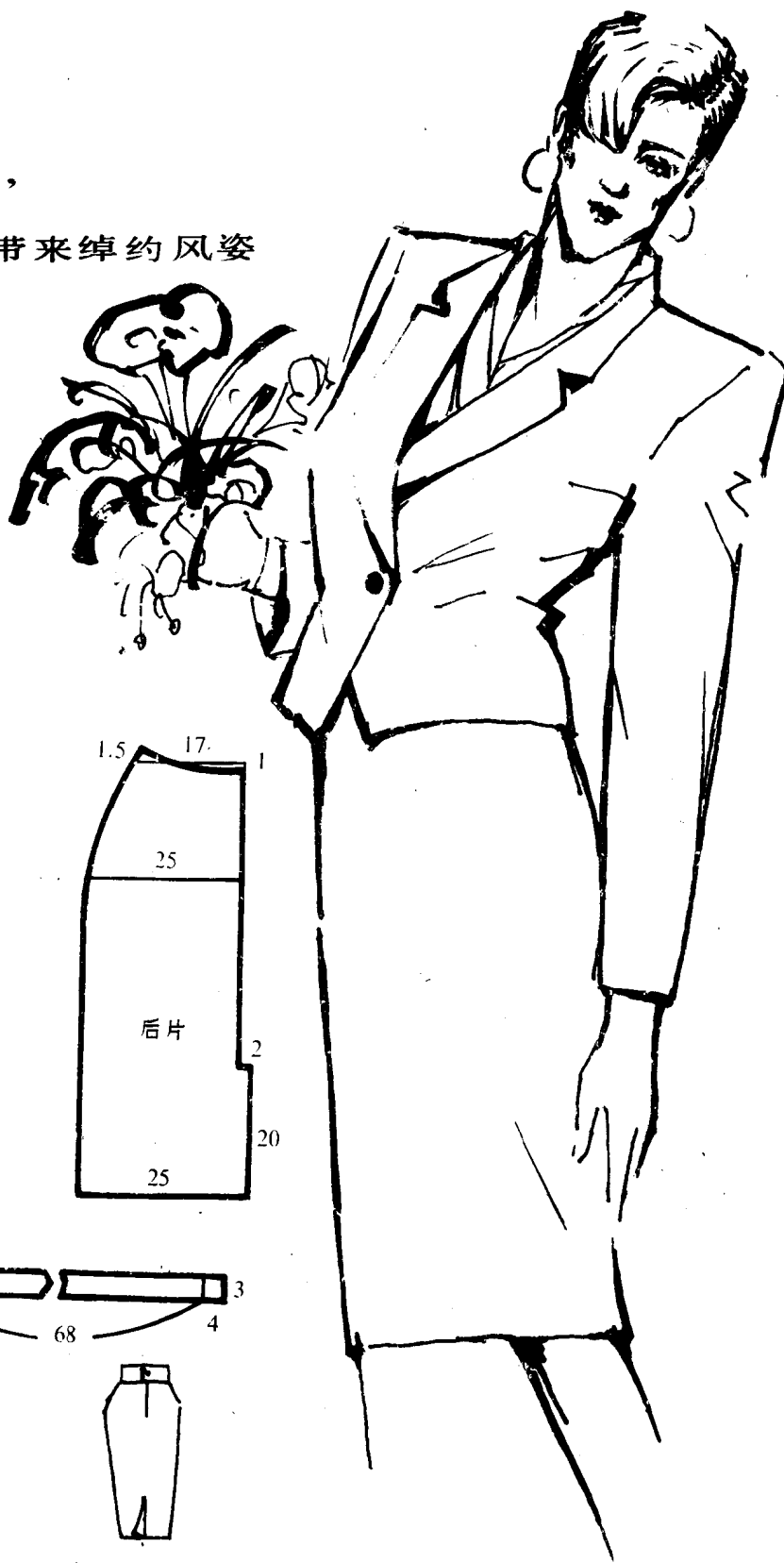

富有运动员气质的假日便裙

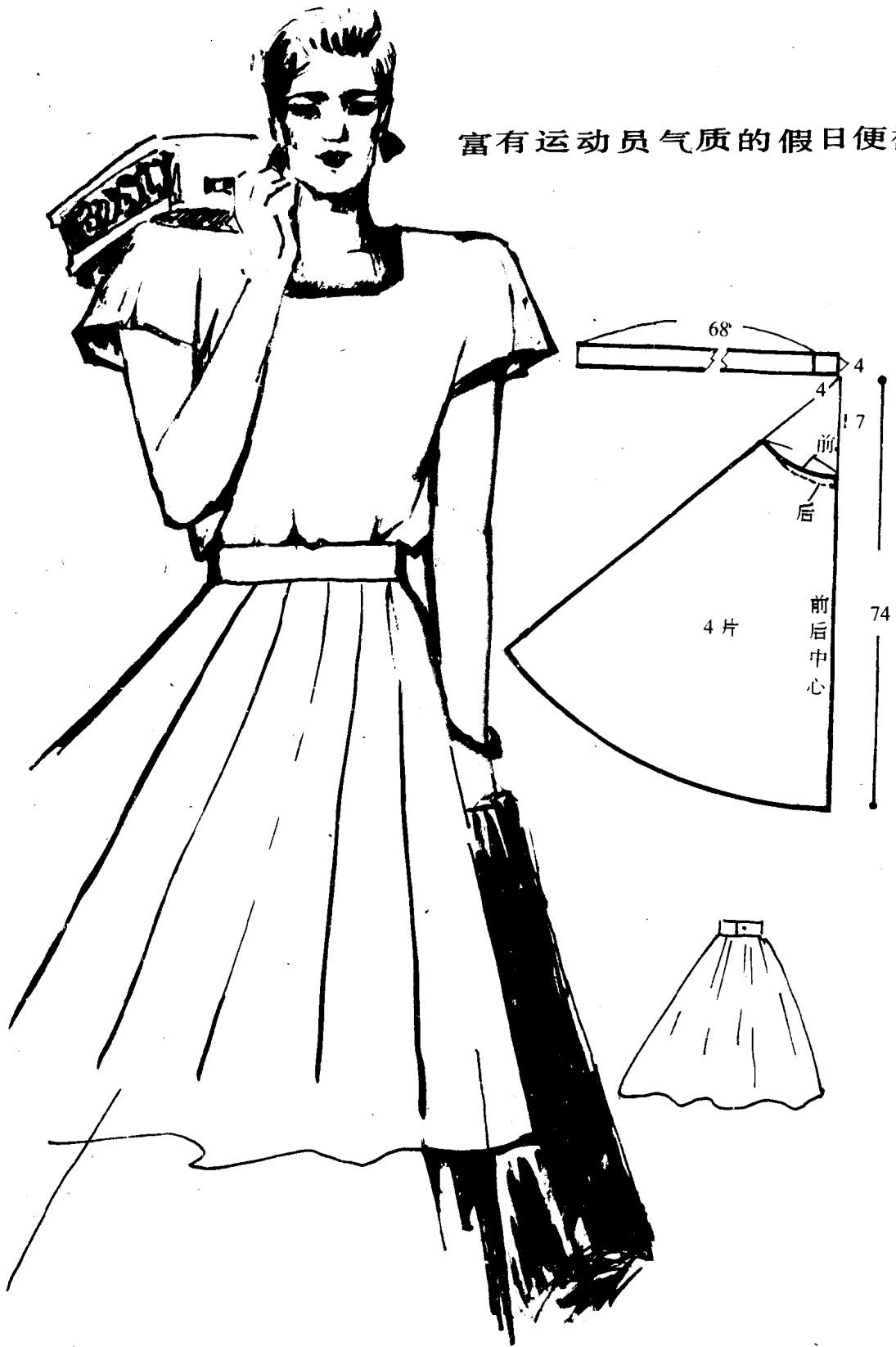



线条流畅的斜裙，更显淑女仪态

