

# 可爱的童装

(第一集)



中国对外经济贸易出版社









957.11

15222.15  
定价2.60元

TS95/11

14

1

款式编号 1—70

062190

一、漂亮的外出装

- 装饰有布花边的凉爽的童装25种款式 (1—25) ..... (4)
- 不受流行款式影响的柔和素雅的连衣裙8种款式 (26—33) ..... (15)
- 印花面料缝制的女童装5种款式 (34—38) ..... (18)
- 带有刺绣装饰的女童装26种款式 (39—64) ..... (20)
- 式样考究的秋装和暖和的外衣6种款式 (65—70) ..... (34)

款式编号71—258

二、按4至6岁年龄顺序编选的童便服

4岁左右102种款式

- 凉爽可爱的太阳装22种款式 (71—92) ..... (39)
- 春夏两季皆宜的简便连衣裙19种款式 (93—111) ..... (46)
- 适于春秋穿着的无袖裙17种款式 (112—128) ..... (52)
- 适于配套穿着的短裙和裤子24种款式 (129—152) ..... (59)
- 适于凉爽天气穿着的轻便马甲套装11种款式 (153—163) ..... (69)
- 暖和便利的茄克和外套9种款式 (164—172) ..... (75)

6岁左右86种款式

- 避暑疗养时穿着的时髦太阳装24种款式 (173—196) ..... (81)
- 简单易制的布料连衣裙和无袖裙37种款式 (197—233) ..... (90)
- 天真顽皮的童装和短裙25种款式 (234—258) ..... (104)

童装用布一览表 ..... (3)

刺绣的基本方法 ..... (3)

登丽美式童装原型做法 ..... (115)

富有东方色彩的国外流行童装款式495种，配有科学的裁剪图，省料、省工、容易制作，是父母、家庭、个体户、服装店和童装工厂难得的一本工具书，对搞好我国出口童装设计很有参考价值。

本书所刊童装款式，由享有盛誉的日本镰仓书房向世界各国推荐，被认为是最受欢迎的童装款式之集大成。本社于1982年5月由日文翻译出版，受到我国广大读者热烈欢迎。这次出版，在原书基础上作了增减，去掉了前面的照片部分和27种女童款式，增加了55种男童装款式，保留了所有的裁剪图，使实用性更突出了。本书分一、二集出版，均在1985年内发行。











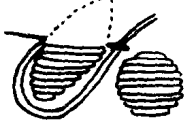
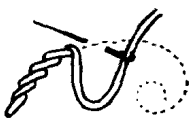
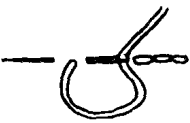

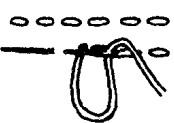
在一本书里，要把这么多的裁剪图依次排列好，是个复杂的技术问题。我们在编排时，尽量按目录排列，但类与类之间、第一集和第二集之间也难免有款式错前或错后的情况，请读者阅读时注意。

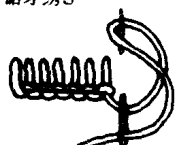
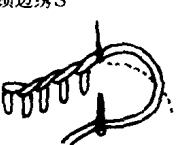
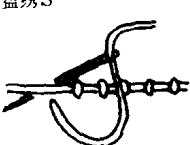
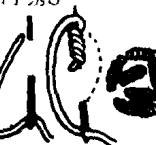
# 童装用布一览表

12岁	10岁	8岁	6岁	4岁	2岁	年龄 幅宽	种类	12岁	10岁	8岁	6岁	4岁	2岁	年龄 幅宽	种类
1.8	1.6	1.5	0.9	0.7	0.6	90厘米	连衣裙	2.1	1.9	1.7	1.2	1.1	0.9	90厘米	无袖裙
2.0	1.8	1.6	1.5	1.2	1.0	90厘米	连衣裙	1.6	1.3	1.2	1.1	0.9	0.8	90厘米	女衬衫
1.0	0.9	0.8	0.7	0.6	0.5	90厘米	裤子	1.2	1.1	1.0	0.9	0.8	0.6	90厘米	裙子
1.5	1.3	1.2	1.0	0.9	0.8	90厘米	衬衣	1.2	1.1	1.0	0.9	0.7	0.6	90厘米	背带裙
2.0	1.7	1.6	1.5	1.4	1.3	90厘米	背心裙套装	1.5	1.3	1.2	1.1	1.0	0.6	90厘米	太阳装

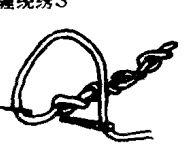
## 刺绣的基本方法

S (针迹)

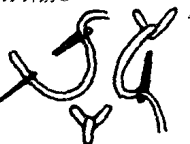
平绣S 	柳绣S 	背绣S 	直线绣S 	拱针绣S 	十字绣S 
锯齿绣S 	锁边绣S 	盘绣S 	结子绣S 	粗线绣S 	疙瘩绣S 
绕针绣S 	缠绕绣S 	拉锁绣S 	套针绣S 	羽状绣S 	钉针绣S 

# 一、漂亮的外出装

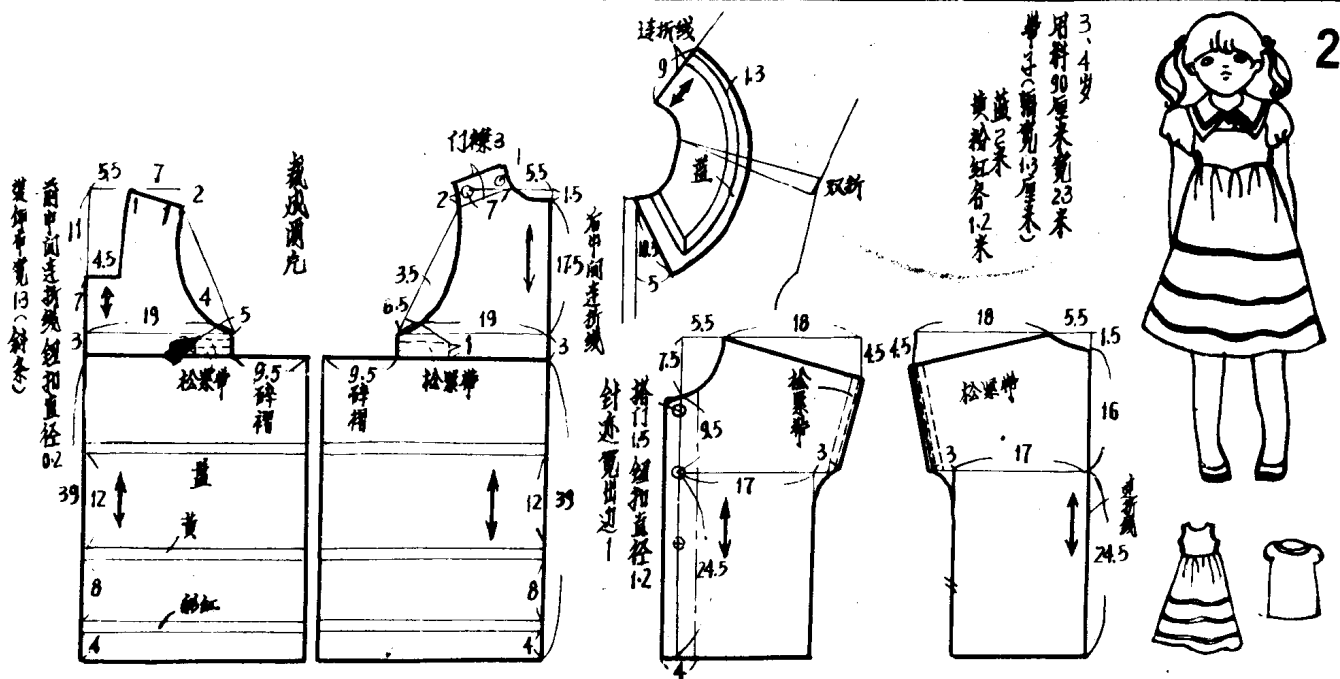
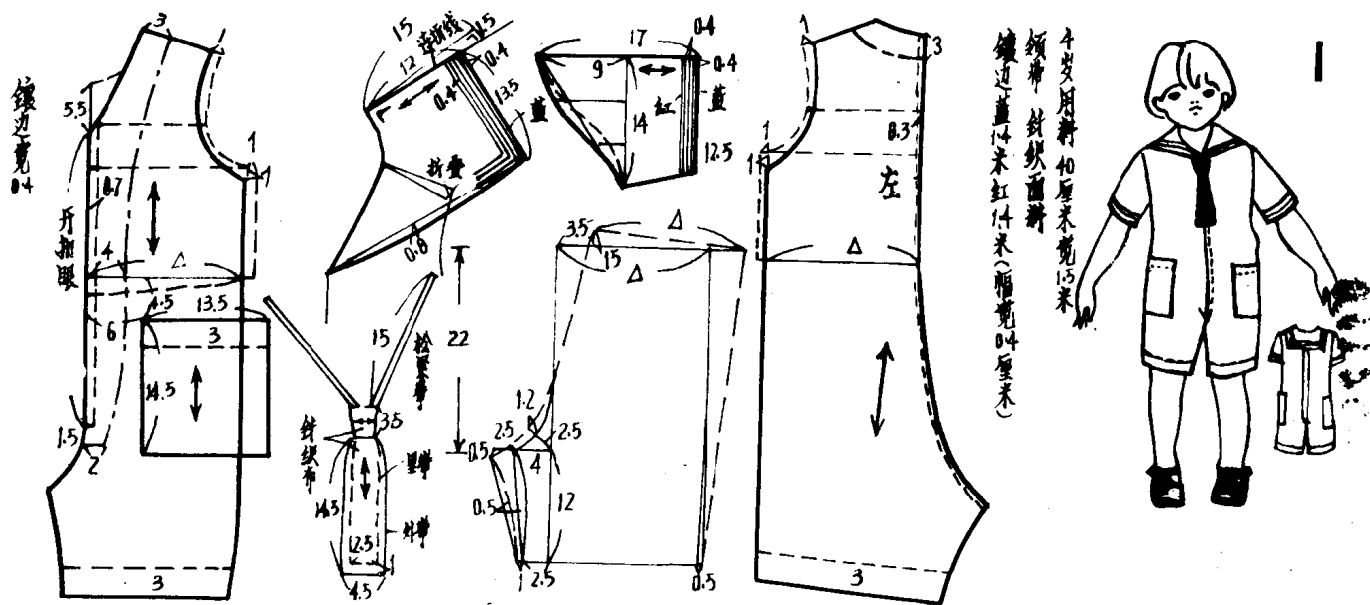

	完成线		直角号		归拢线
	裁剪线		拼接号		拨开号
	贴边线		直纱线	B BUST	胸围
	影示线		毛芒方向	W WAIST	腰围
				H HIP	臀围

制图符号



# 装饰有布花边的凉爽的童装25种款式 (1—25)

7.8岁  
用料 90厘米宽15米  
辅料 月壳90厘米宽0.2米  
带面及绿色面料  
花边宽5厘米的14米  
宽10厘米的12米

花边宽5(长是缝合尺寸约13倍)

前褶边

后褶边

3

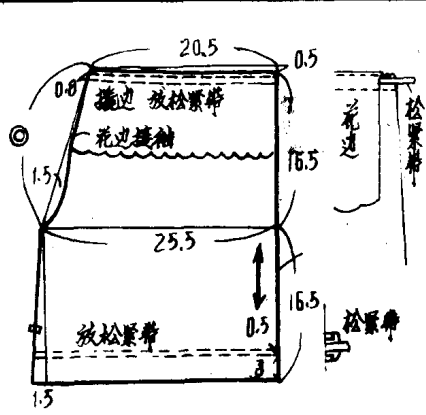
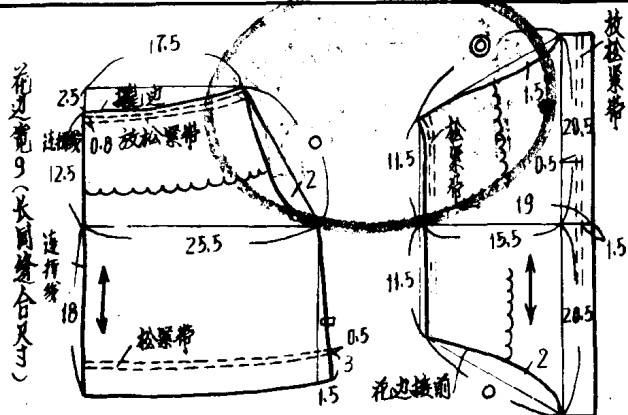
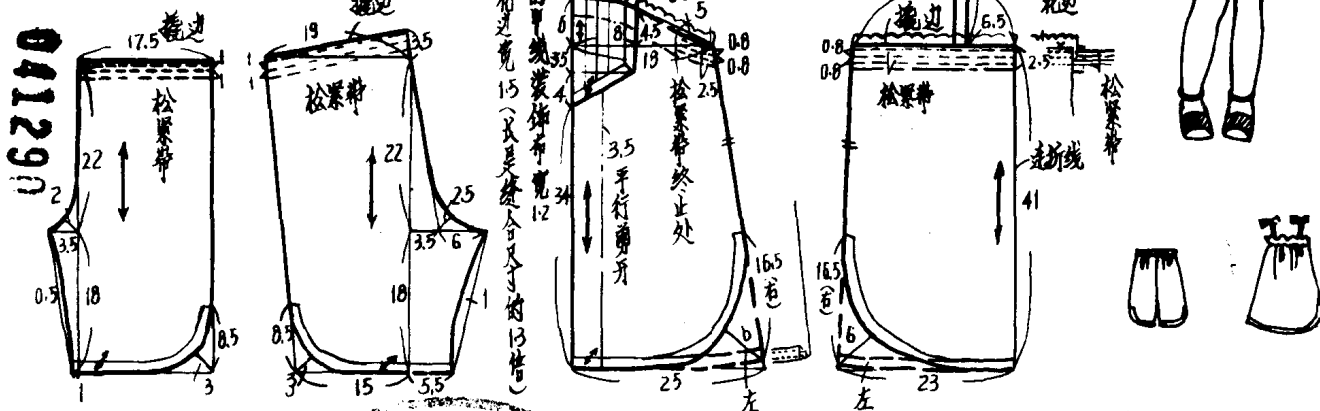

4



4.5岁  
用料: 单衫和裤子  
90厘米宽1.0米  
花边 9厘米宽1.4米  
13...1.4米  
裤子 90厘米宽1.4米

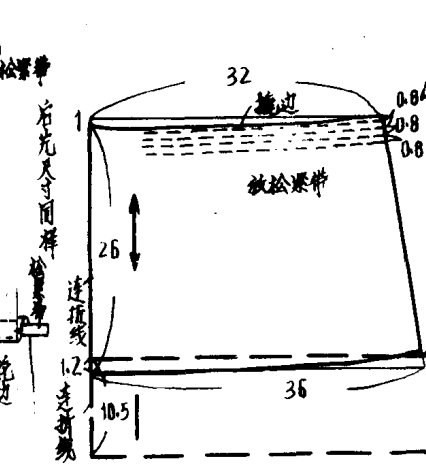
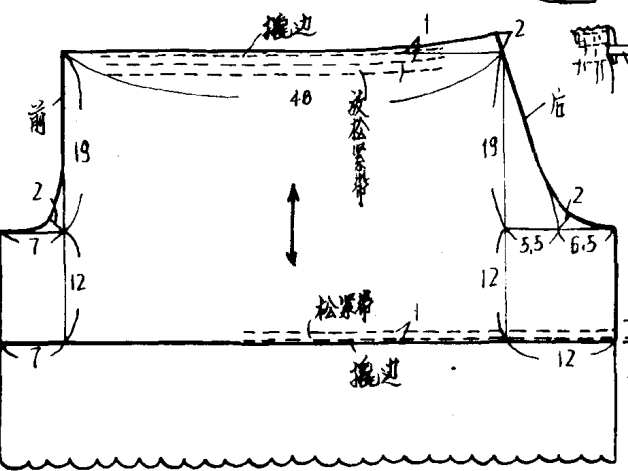

花边宽13(长同缝合尺寸)

5

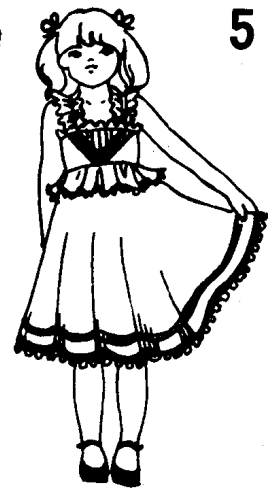

6、7岁  
用料 90厘米宽2米  
袖料 90厘米宽0.2米(前胸部)  
裙料 90厘米宽0.5米(装饰布)  
花边 A 3厘米宽4米  
B 2.7厘米宽5.4米  
C 1.8厘米宽0.4米  
梯形花边 0.8厘米宽0.7米  
缎带 0.5厘米宽1.2米  
里布 90厘米宽1.3米  
腰衬布 1.8厘米宽1.3米(B花边)

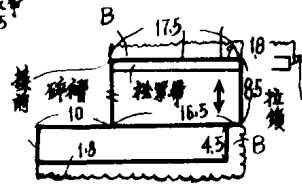
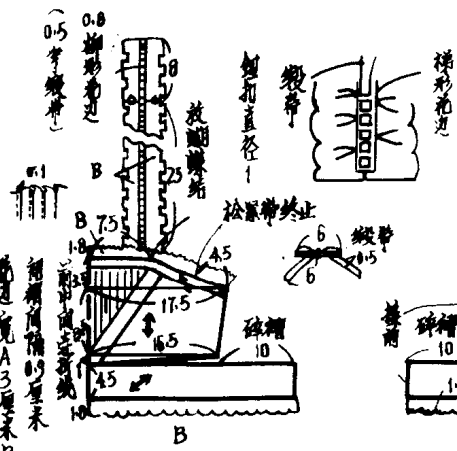

裙料 90厘米宽0.5米  
花边 A 3厘米宽4米  
B 2.7厘米宽5.4米  
C 1.8厘米宽0.4米  
(裙子下摆长度是腰合尺寸1.3倍)  
装饰布宽1厘米

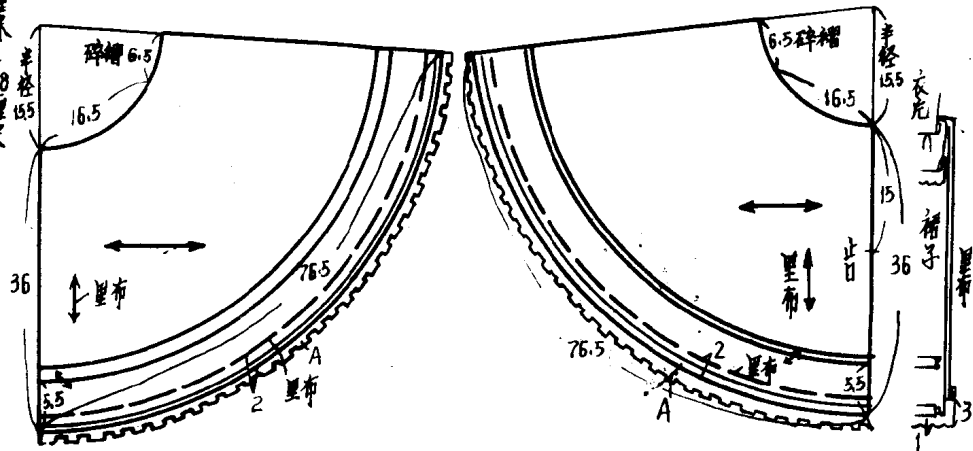

6



4岁  
前片 90厘米宽1.8米  
身片 90厘米宽0.7米  
后片 15厘米宽3.5米

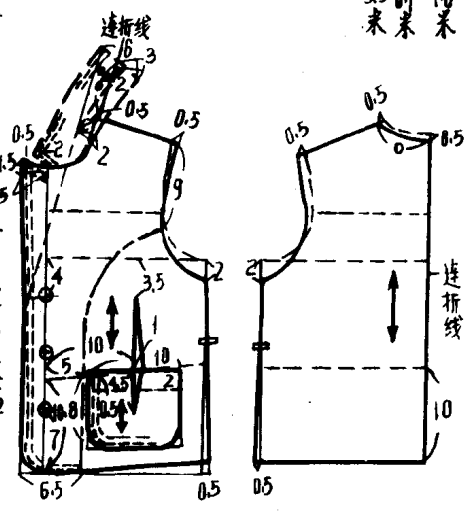
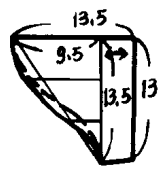
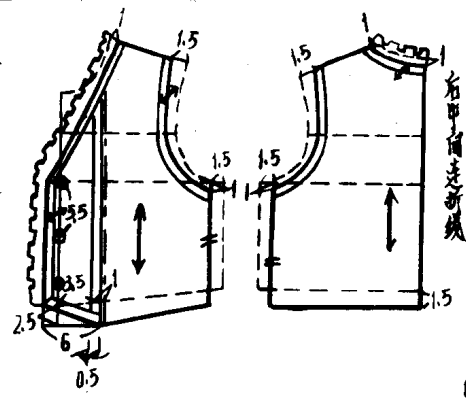

裙料 15厘米宽1.2米  
装饰布宽1厘米  
花边宽1.5(长度是腰合尺寸的1.3倍)

前后片相连折线  
花边宽1.5(长度是腰合尺寸的1.3倍)  
前后尺寸同样



8

4岁  
用料  
连衣裙90厘米宽15米  
花边07厘米宽13米  
围裙90厘米宽13米  
花边1厘米宽26米

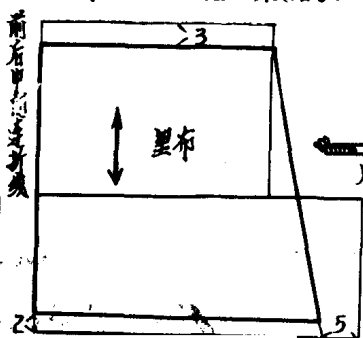
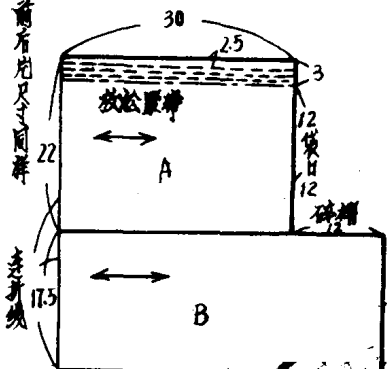
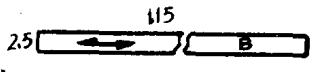
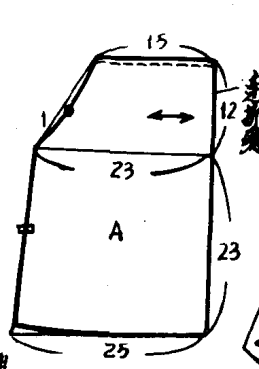
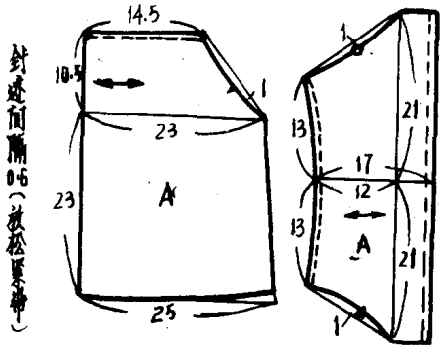

7.8岁  
用料 A 90厘米宽1.4米  
B 90 " " " 1.2米  
里布 90厘米宽0.8米(裙子)



7

挎包裁剪图

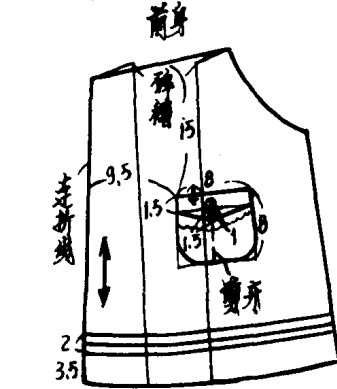
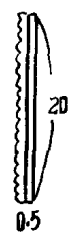
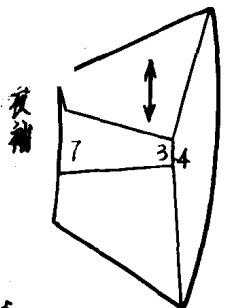
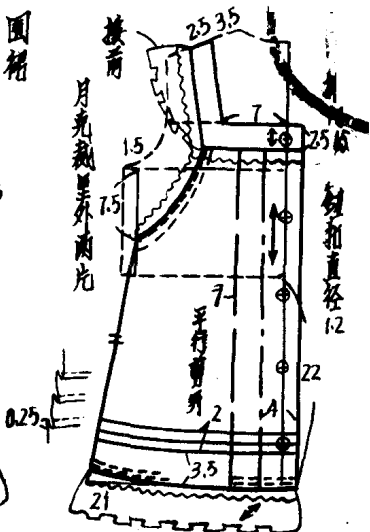
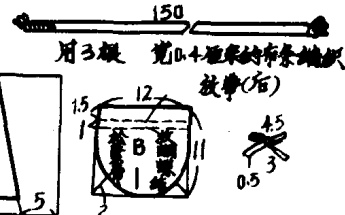

口袋制法

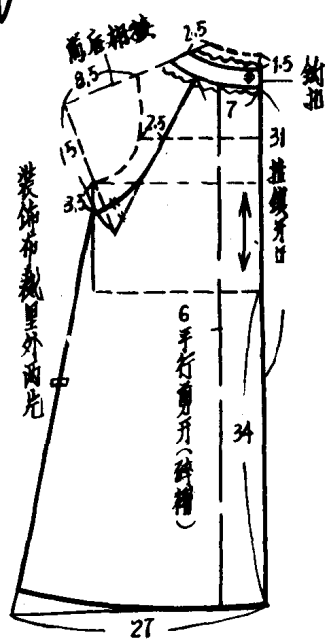
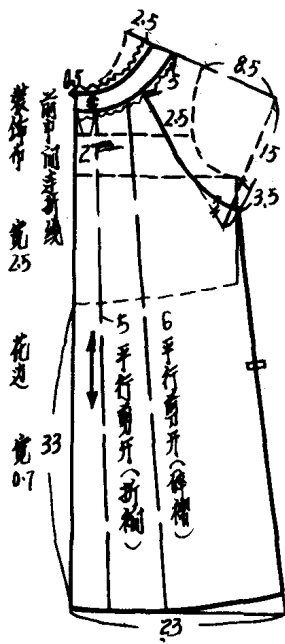

前中缝  
装饰布宽2  
滚边宽0.3  
花边宽1.3 (长是综合尺寸的1.3倍)

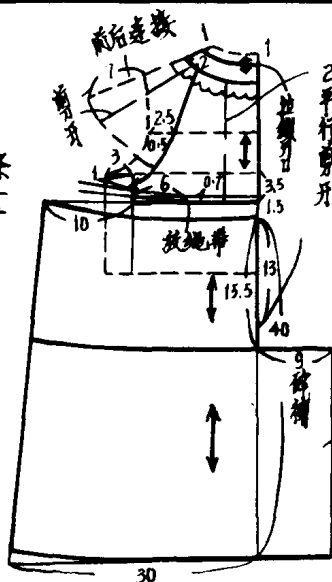
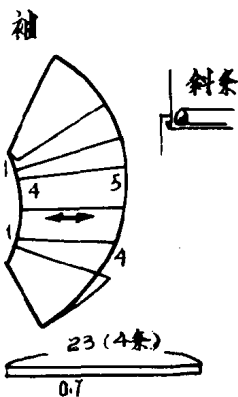
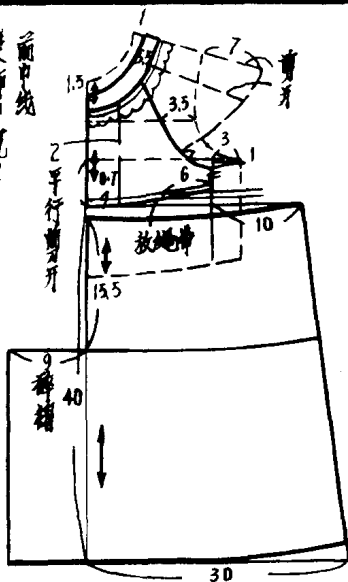

4岁用料90厘米宽1.4米  
装饰布宽2  
滚边宽0.3  
花边宽1.3 (长是综合尺寸的1.3倍)



9

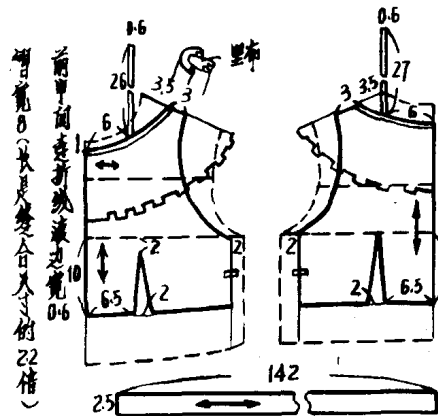
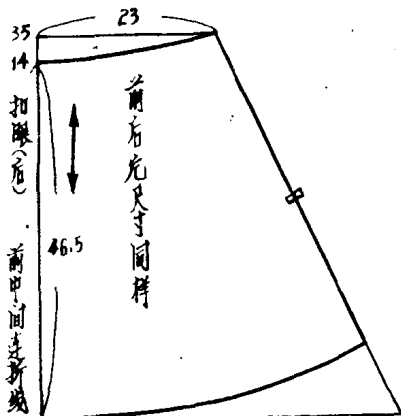

8岁  
前料90厘米宽2米  
里布90厘米宽1.4米



10

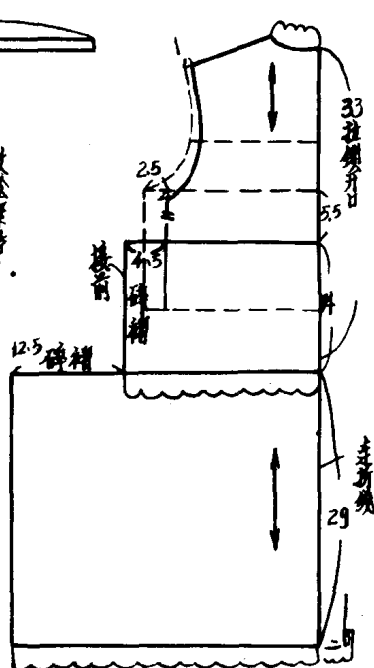
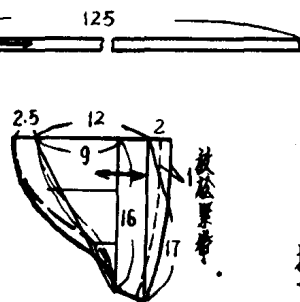
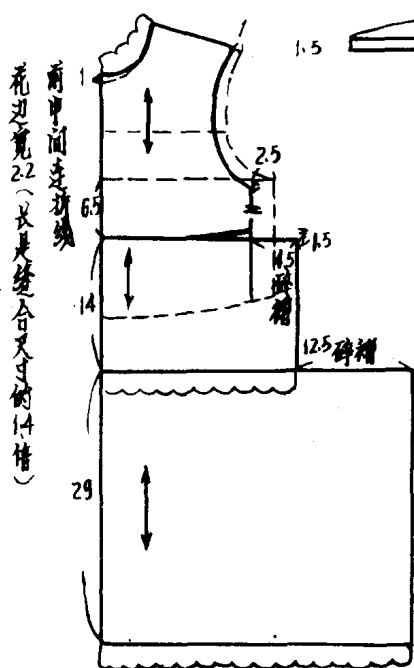

6岁  
用料 90厘米宽1.4米  
花边 2.2厘米宽3.5米

11

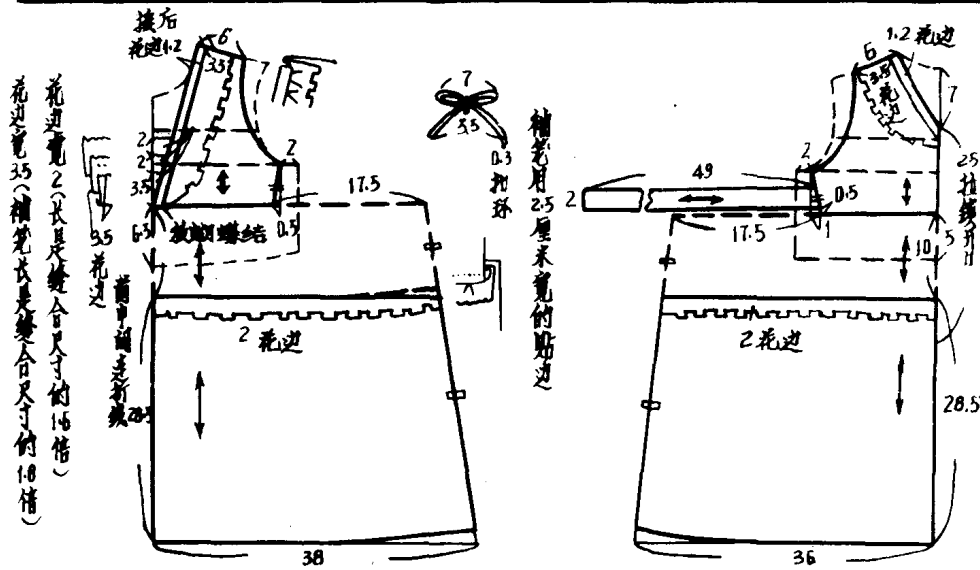

2岁  
用料: 90厘米宽12米  
花边: 2厘米宽22米, 2.5厘米宽15米, 1.2厘米宽10米

12

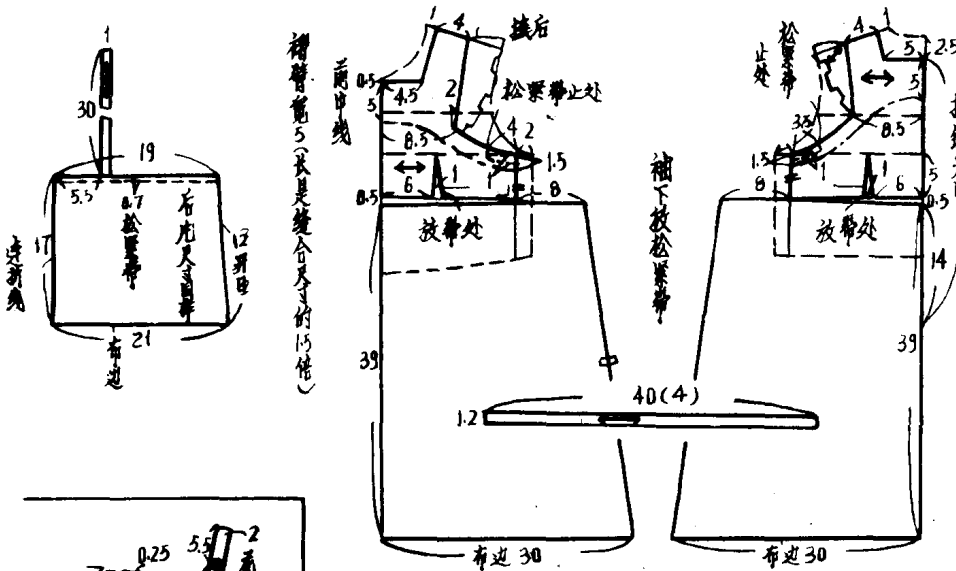

4岁  
用料: 90厘米宽16米  
竖裁时90厘米宽14米

13

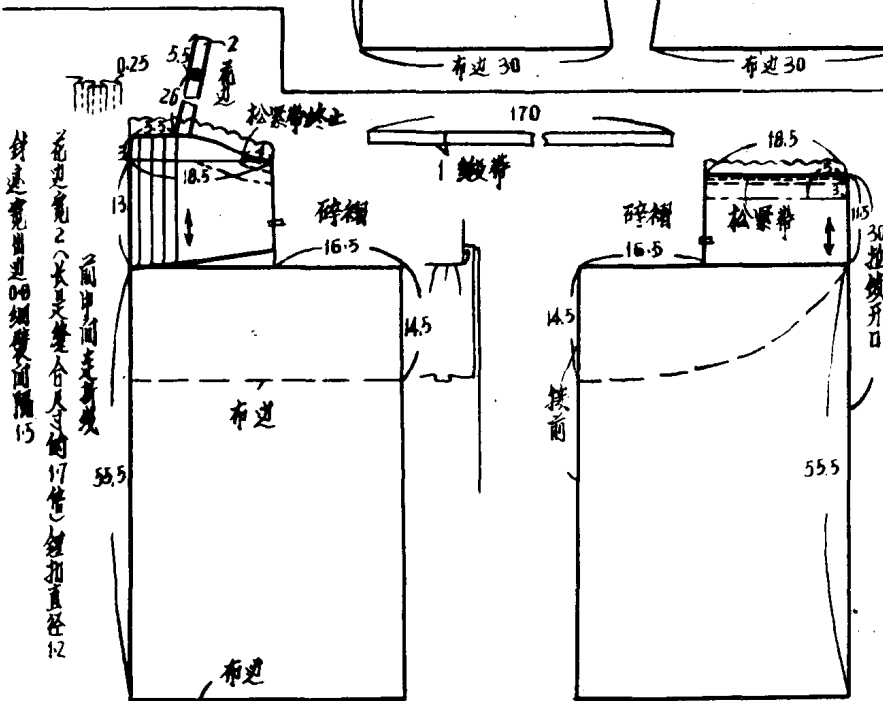

10岁  
用料: 衣片90厘米宽10米, 裙子90厘米宽15米  
花边 (包括吊带) 2厘米宽10米, 2厘米宽14米  
缎带1厘米宽10米  
竖裁时90厘米宽10米 (腰部横打褶)

14





17



6岁  
用料 连衣裙  
上衣 90厘米宽  
花边 1.8厘米宽22米  
0.7厘米宽0.4米



前中时志折线前襟宽2厘米扣直径1.3  
花边下长是总合尺寸约1.5倍  
褶边长是总合尺寸的1.2倍

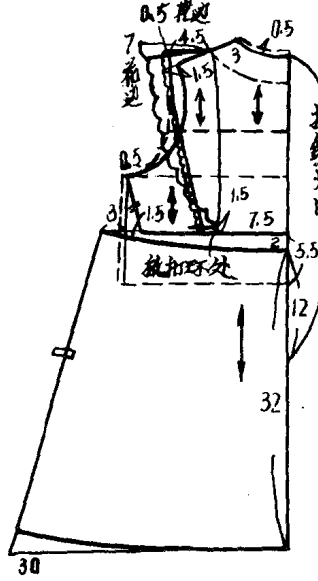
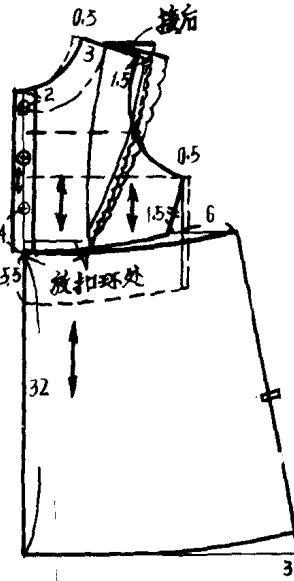

4岁  
用料 90厘米宽12米  
花边 0.5厘米宽1米  
7厘米宽0.4米



15

30(后)2条  
80(前)1条  
0.7扣环

花边宽2, 花边宽6 (褶边长是总合尺寸的2倍)  
针迹宽是1

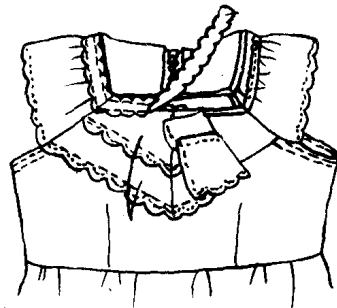

6岁  
用料 90厘米宽13米  
花边 6厘米宽25米  
3厘米宽0.8米

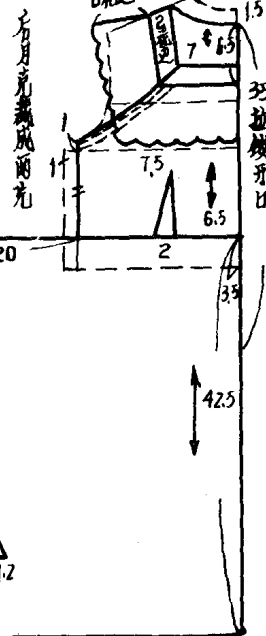

16

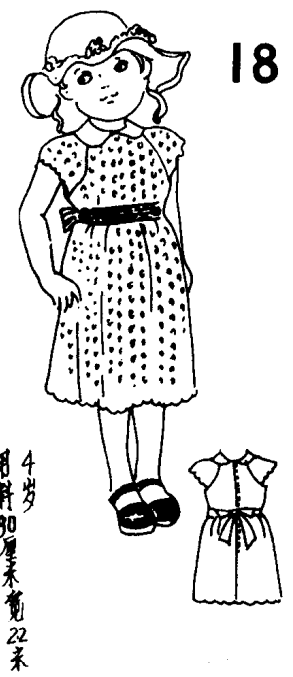
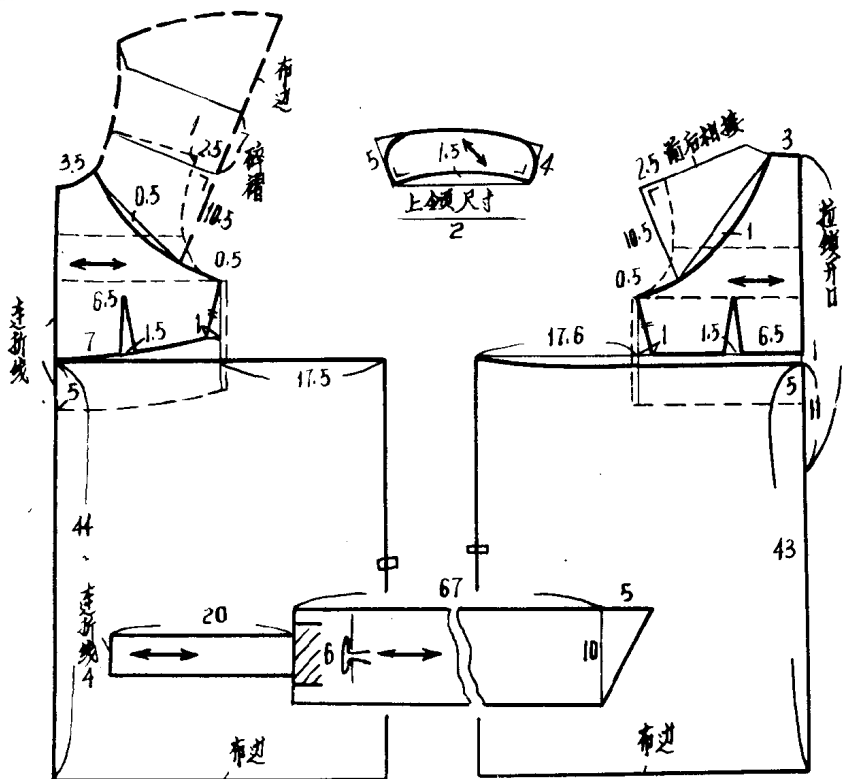
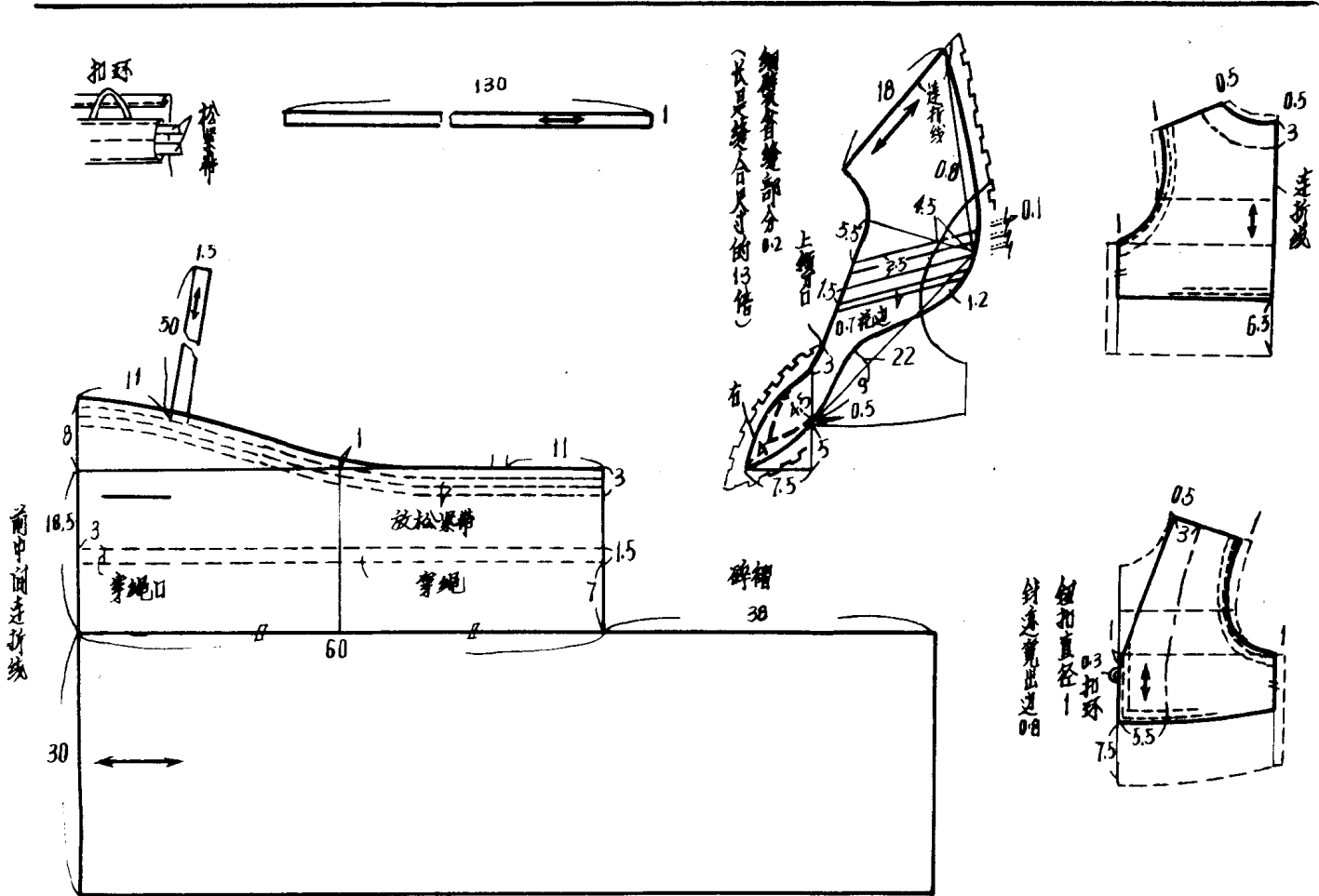

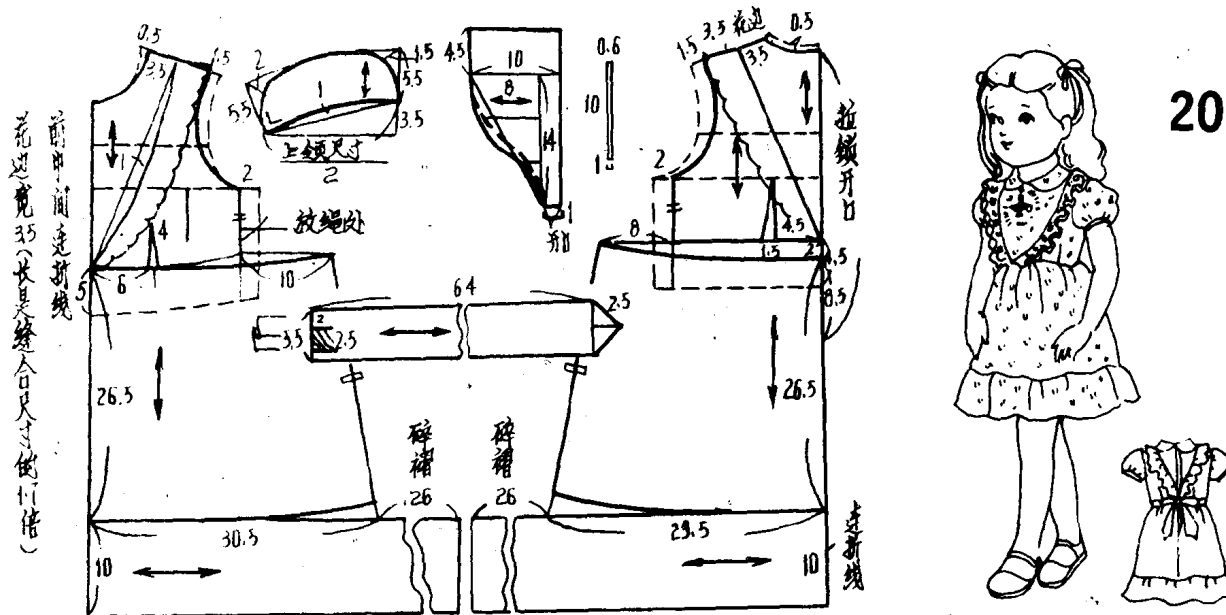
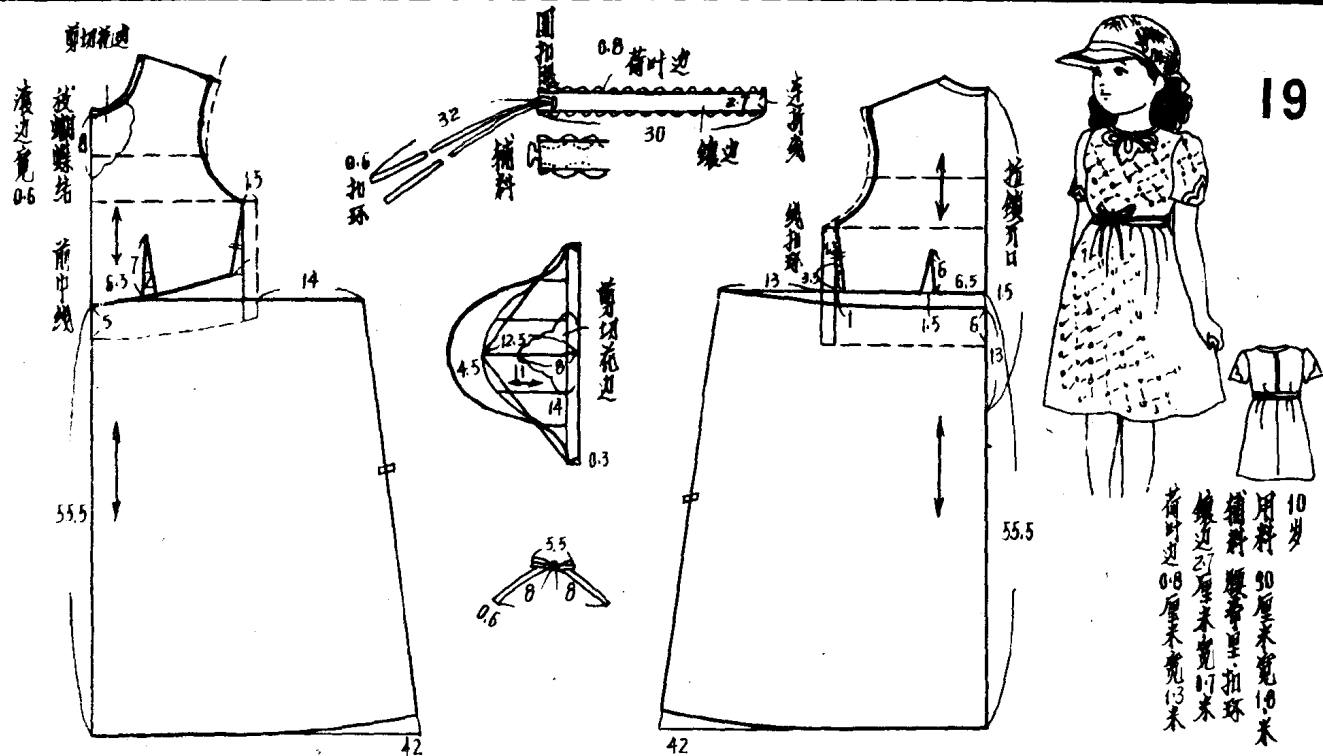

- 用25号刺绣线
- 平绣S (4条)
  - 绕针绣S (6条)
  - 柳绣S (3条)
  - 结子绣S (6条)





21

8岁



用料 细呢米宽22米  
 辅料 90厘米米宽08米  
 (包花腰带滚边)

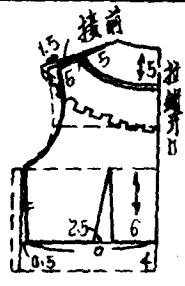

前前后后花裁里外洞光  
 滚边宽08  
 褶边宽是缝合尺寸  
 的2倍

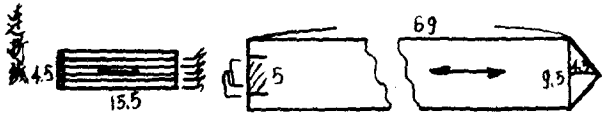
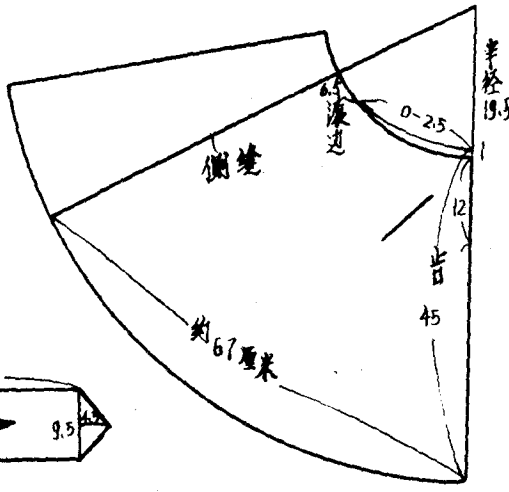
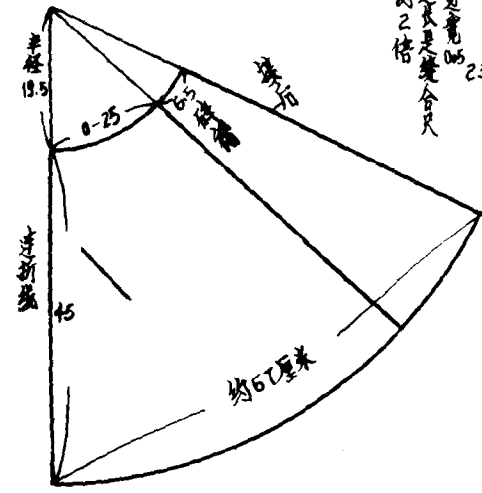

22

10岁



用料 90厘米米宽2米  
 辅料 90厘米米宽08米  
 (包花腰带滚边)  
 花边布  
 月亮、褶  
 花边 25厘米米宽09米

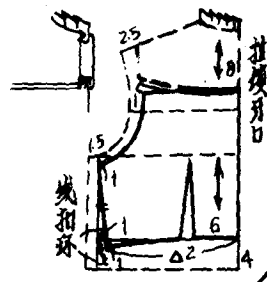

月亮裁成里外洞光  
 前中幅连折线  
 滚边宽08  
 褶边宽15  
 (头尾缝合尺寸是褶边  
 的2倍)

