



# 3ds Max

## 工业产品设计高级实例教程

田庆 © 编著

丰富的教学案例和实用的技术讲解,让您轻松学习并快速提高设计水平

30个典型案例,  
全面解读各类工业产品模型的  
制作方法和技巧

超值赠送 **2 DVD**

33小时语音视频教学,  
详细讲解模型制作全过程

中国铁道出版社  
CHINA RAILWAY PUBLISHING HOUSE

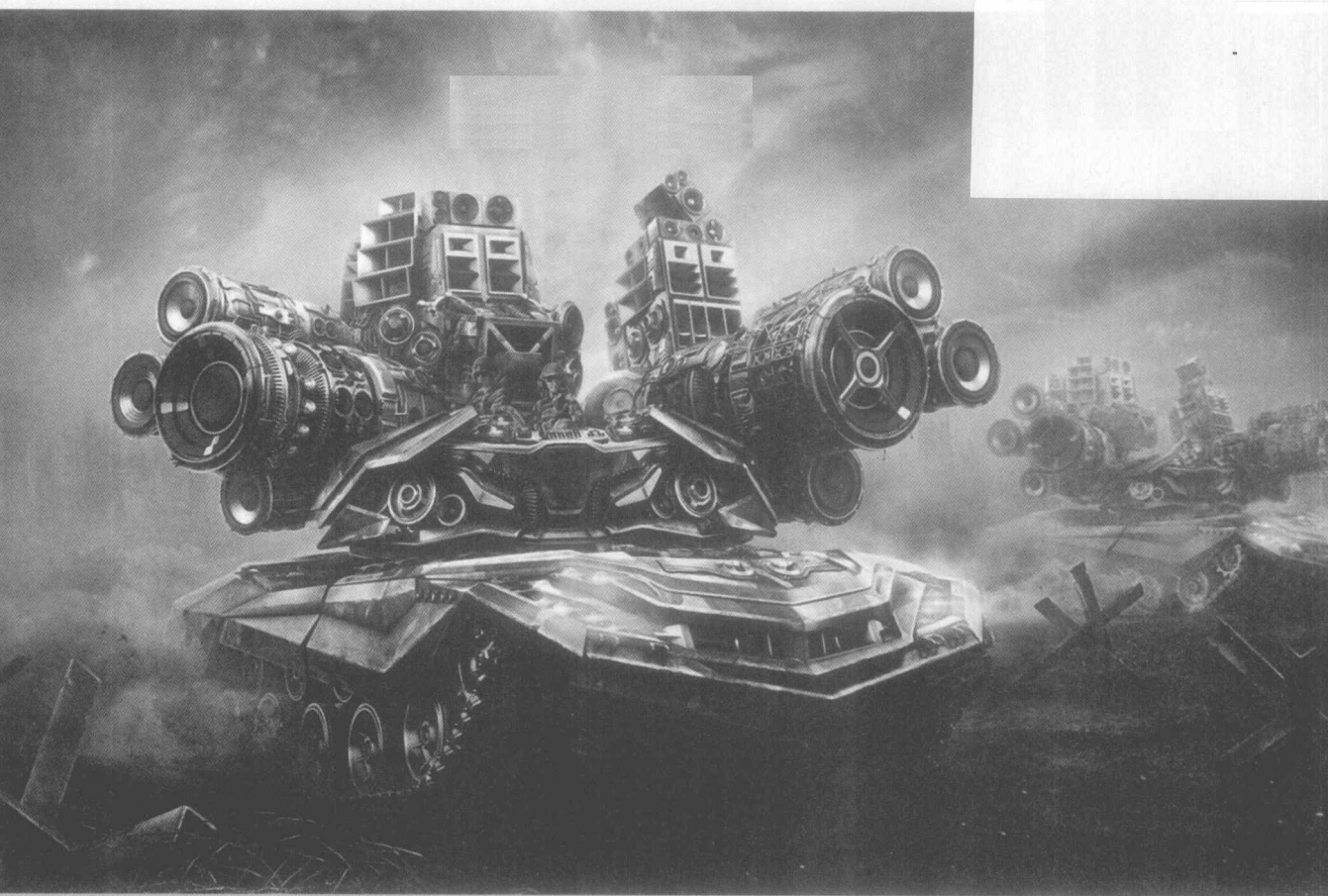

# 3ds Max

## 工业产品设计高级实例教程

中国铁道出版社  
CHINA RAILWAY PUBLISHING HOUSE

## 内 容 简 介

书中通过近 30 个模型实例,由浅入深,详细讲解了使用 3ds Max 制作产品模型的各种高级技术。具体内容包括:3ds Max 概述及建模基础,五金工具类模型制作,礼品和工艺品建模,运动器械模型制作,照明灯具模型制作,家居产品建模,厨卫产品建模,儿童玩具模型制作,电子通信产品模型制作,家电设备模型制作,数码和电脑产品模型制作,交通工具模型制作,武器类模型制作。通过学习本书,读者可掌握使用 3ds Max 进行快速、精确的工业产品建模,并为最终进行产品渲染奠定良好的基础。

附赠光盘中提供书中实例的场景文件,以及讲解实例制作全过程的语音视频教学文件。

本书适合从事工业造型设计的人员和游戏三维场景建模的美工及建模爱好者学习使用,也可作为大、中专院校和培训机构工业产品设计及其相关专业的教材。

### 图书在版编目(CIP)数据

3ds Max 工业产品设计高级实例教程 / 田庆编著. —  
北京:中国铁道出版社,2015.8  
ISBN 978-7-113-13594-2

I. ①3… II. ①田… III. ①工业产品—计算机辅助  
设计—应用软件—教材 IV. ①TB472-39

中国版本图书馆 CIP 数据核字(2015)第 125813 号

书 名: 3ds Max 工业产品设计高级实例教程

作 者: 田 庆 编著

责任编辑: 于先军

读者服务热线: 010-63560056

责任印制: 赵星辰

封面设计: 多宝格

出版发行: 中国铁道出版社(北京市西城区右安门西街 8 号 邮政编码: 100054)

印 刷: 北京尚品荣华印刷有限公司

版 次: 2015 年 8 月第 1 版 2015 年 8 月第 1 次印刷

开 本: 787mm×1092mm 1/16 印张: 23.5 插页: 8 字数: 557 千

书 号: ISBN 978-7-113-13594-2

定 价: 79.80 元(附赠 2DVD)

版权所有 侵权必究

凡购买铁道版图书,如有印制质量问题,请与本社教材图书营销部联系调换。电话:(010) 51873174

打击盗版举报电话:(010) 51873659



2.1

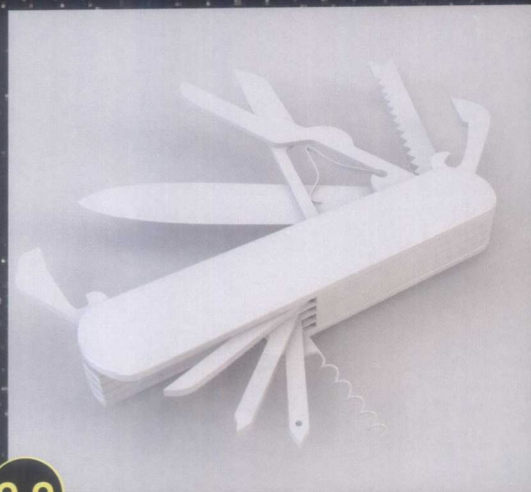

2.2



3.1

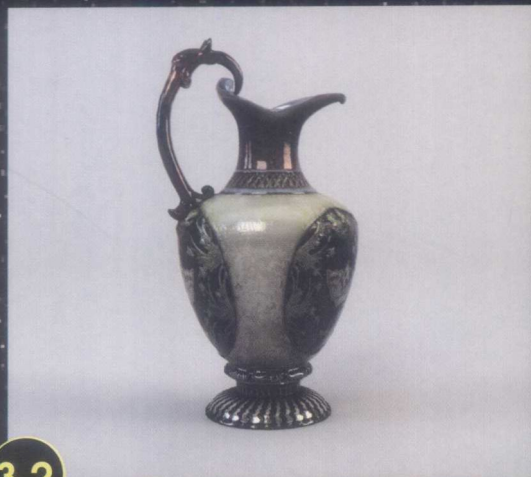

3.2

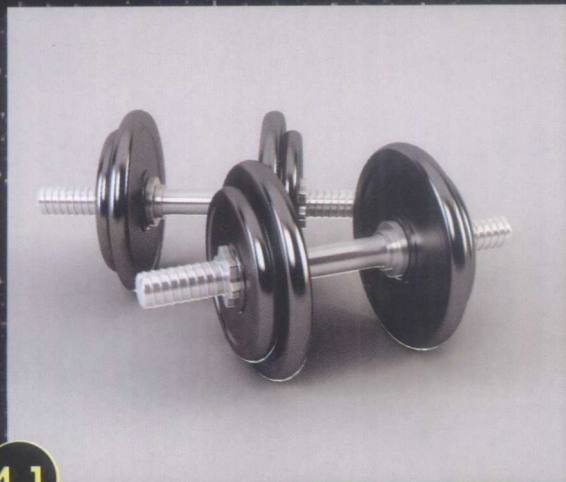

4.1



4.2

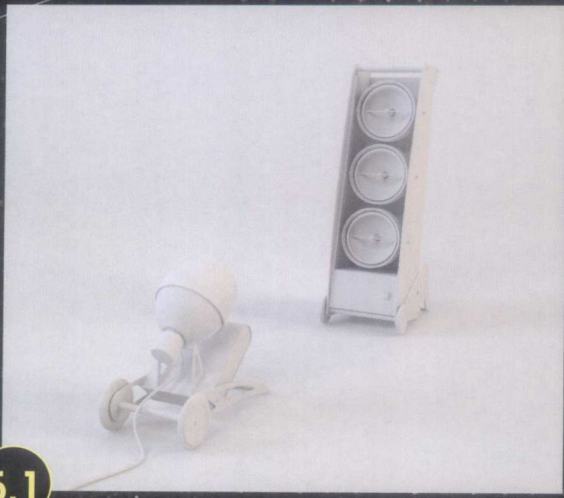

5.1



5.2



6.1



6.2



7.1



7.2



8.1



8.2



9.1



9.2



10.1

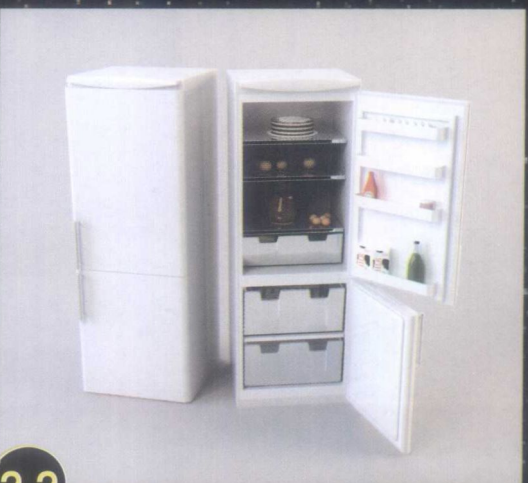

12.2

# 3ds Max 工业产品设计高级实例教程



11.1



11.1



12.1



12.2



13.1



13.2

## DVD 01 学习内容

### 第1章

基础介绍1 (视频教学时长18分14秒)

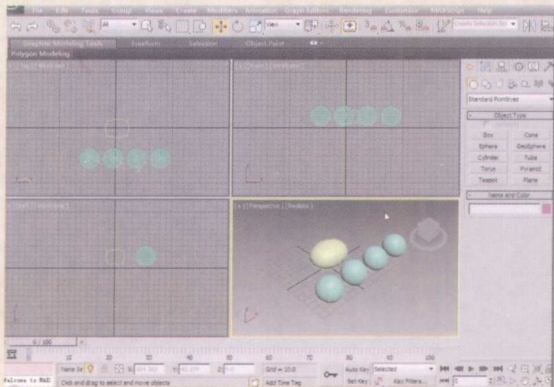

基础介绍2 (视频教学时长48分11秒)

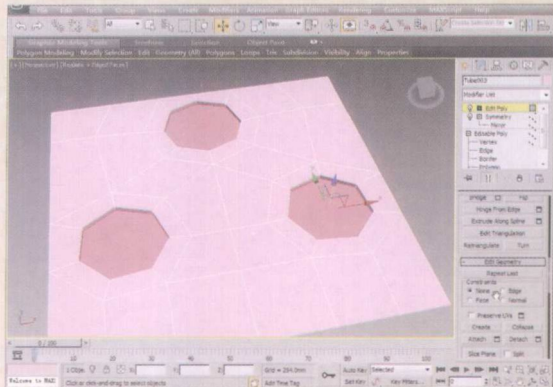

### 第2章

厨具1 (视频教学时长29分08秒)

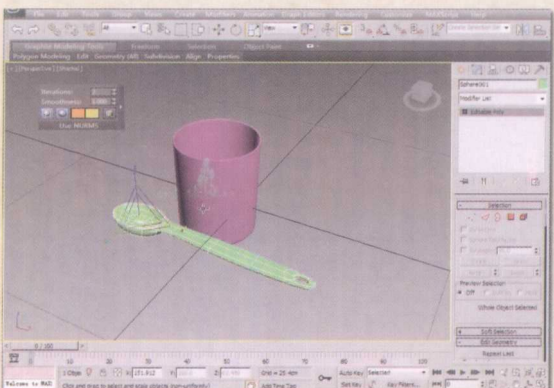

厨具2 (视频教学时长26分30秒)

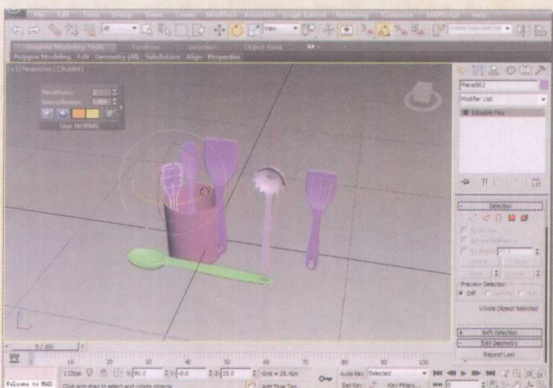

瑞士军刀1 (视频教学时长30分54秒)

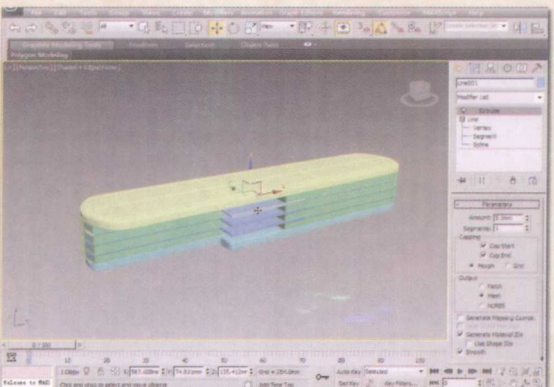

瑞士军刀2 (视频教学时长31分47秒)

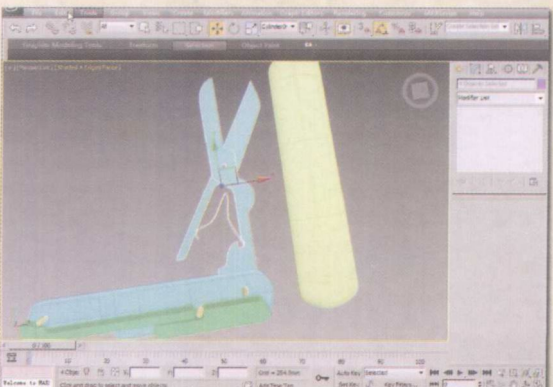



# 3ds Max 工业产品设计高级实例教程

## 第3章 //

瑞士军刀3 (视频教学时长35分26秒)

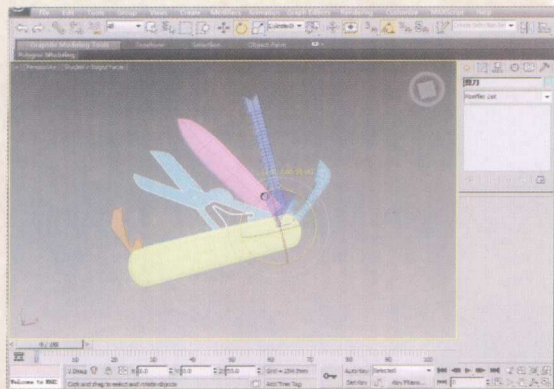

礼品1 (视频教学时长26分26秒)

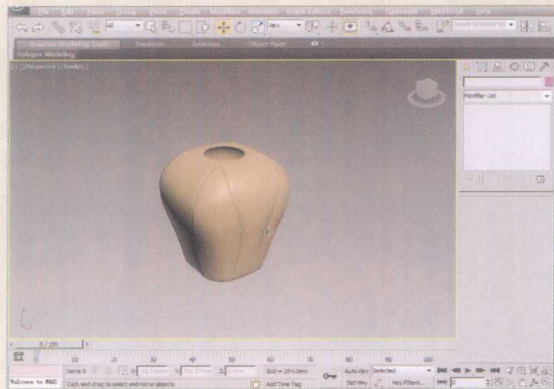

礼品2 (视频教学时长31分36秒)

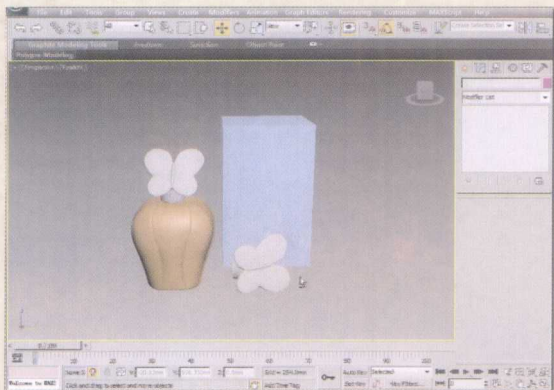

艺术花瓶 (视频教学时长46分37秒)

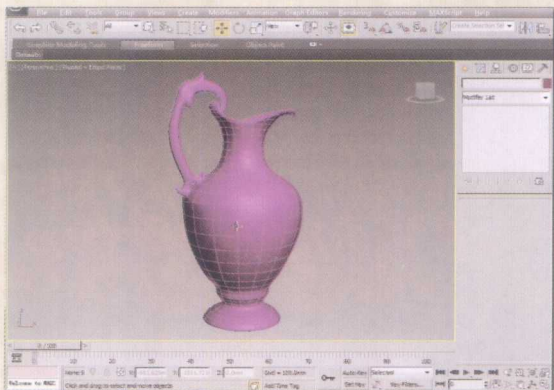

## 第4章 //

溜冰鞋1 (视频教学时长23分14秒)

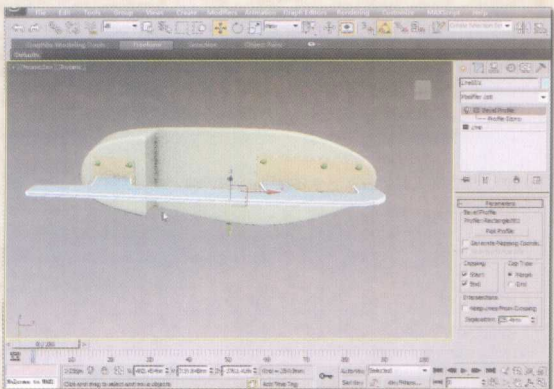

溜冰鞋2 (视频教学时长25分53秒)

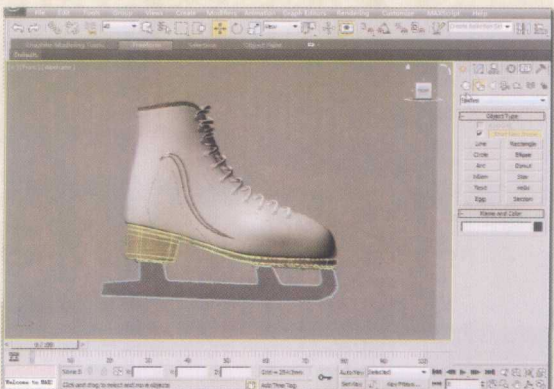

溜冰鞋3 (视频教学时长43分25秒)

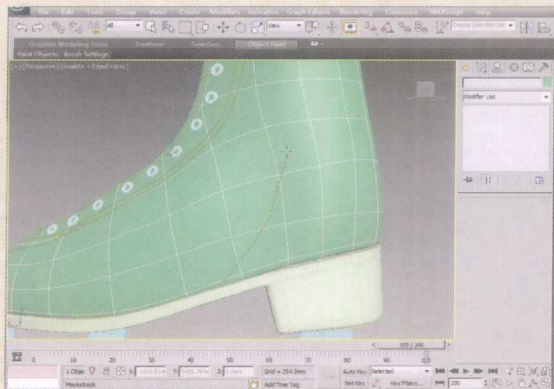

溜冰鞋4 (视频教学时长25分34秒)

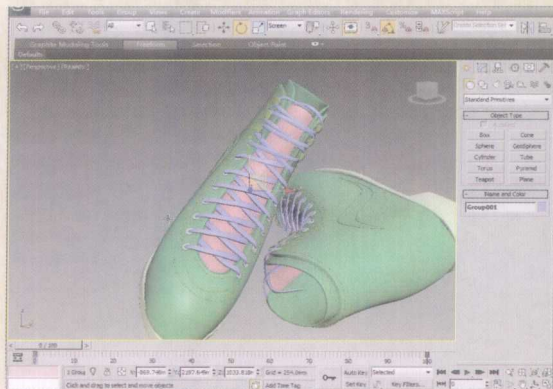

哑铃 (视频教学时长21分23秒)

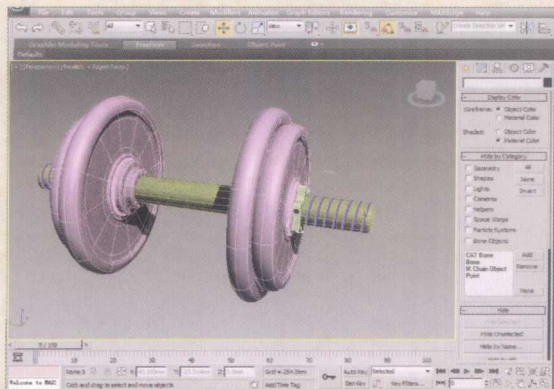

## 第5章

仿古壁灯1 (视频教学时长20分41秒)

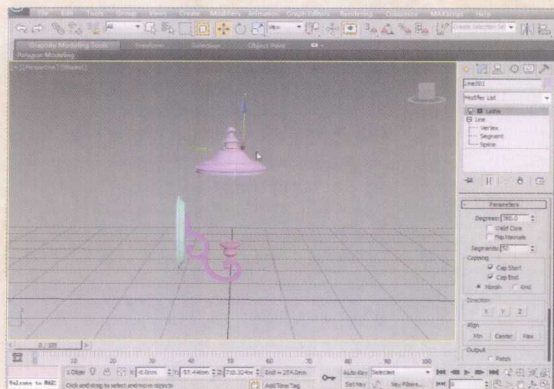

仿古壁灯1 (视频教学时长27分06秒)

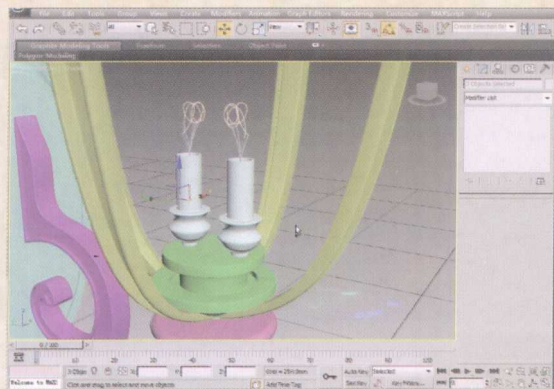

仿古壁灯3 (视频教学时长25分44秒)

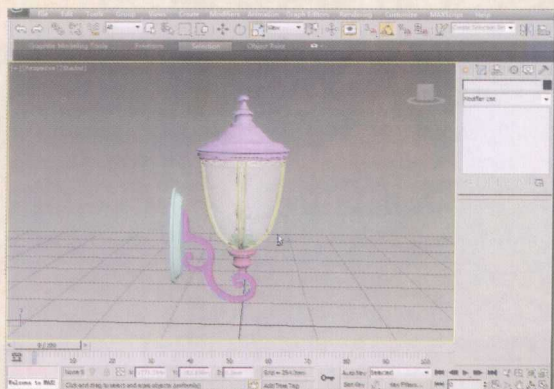

现代灯1 (视频教学时长10分27秒)

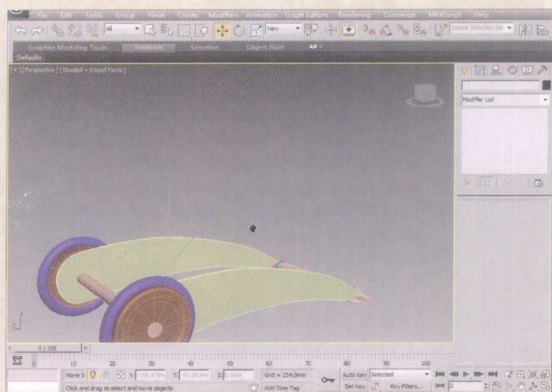

现代灯2 (视频教学时长23分23秒)

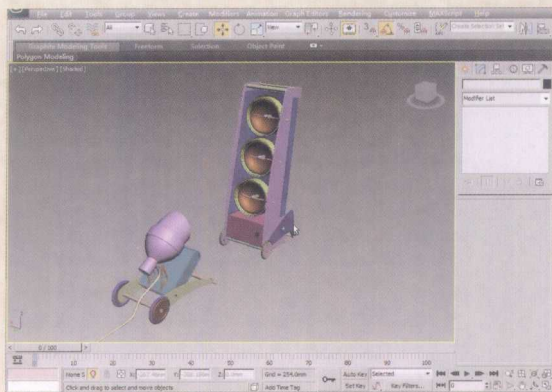

## 第6章

电熨斗1 (视频教学时长22分00秒)

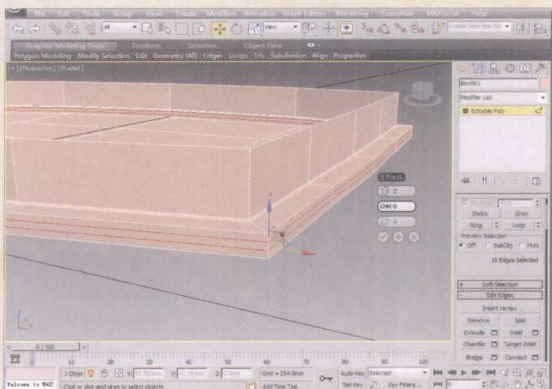

电熨斗2 (视频教学时长32分59秒)

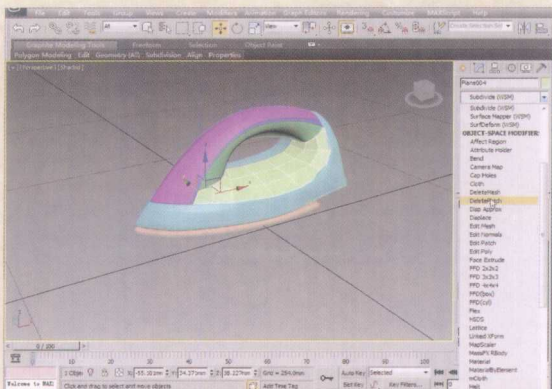

电熨斗3 (视频教学时长23分34秒)

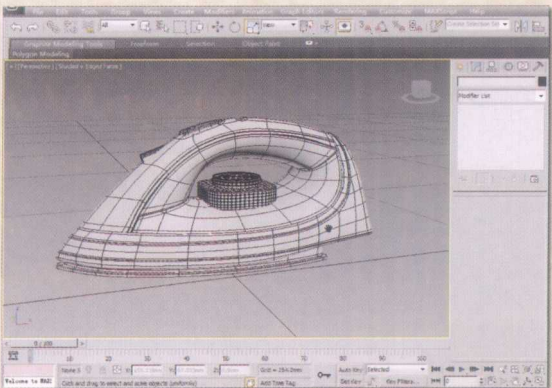

热水壶1 (视频教学时长31分23秒)

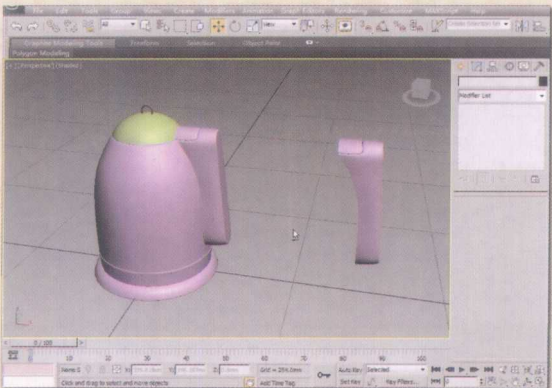

## 第7章

热水壶2 (视频教学时长16分50秒)

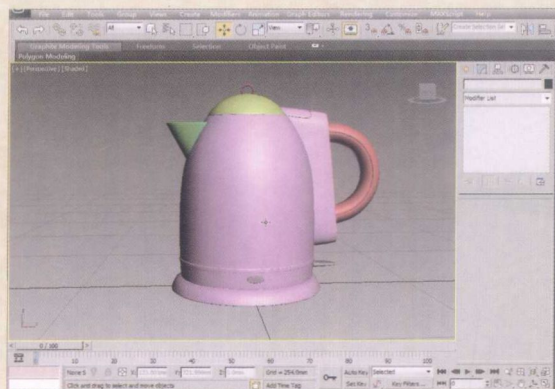

茶具 (视频教学时长32分56秒)

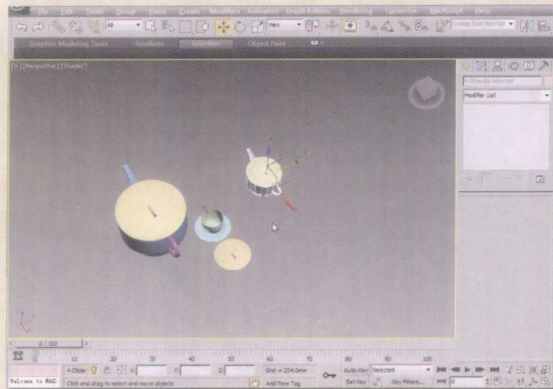

洗手池1 (视频教学时长09分40秒)

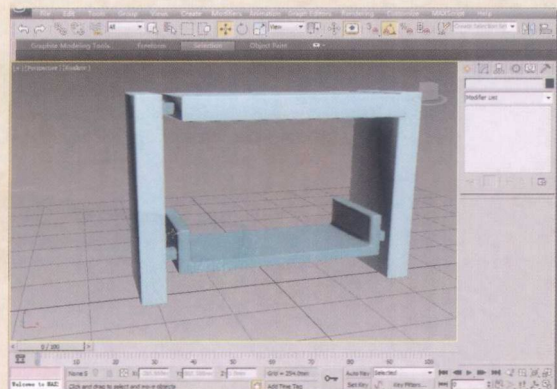

洗手池2 (视频教学时长44分37秒)

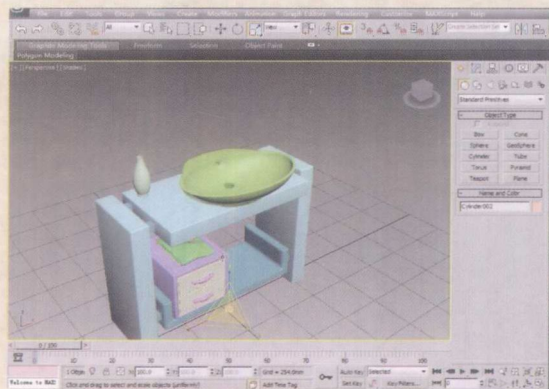

洗手池3 (视频教学时长14分41秒)

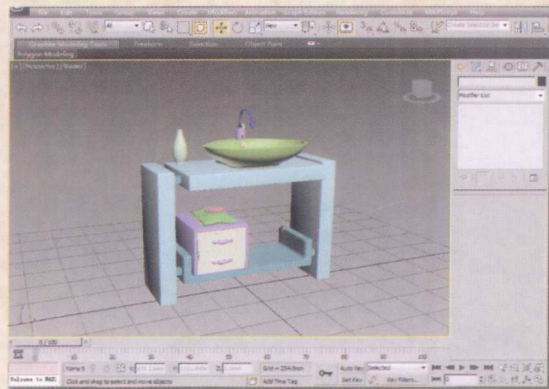

## 第8章

兔子 (视频教学时长36分21秒)

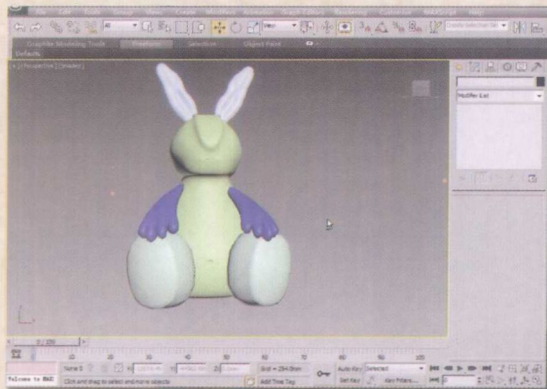

小海龟1 (视频教学时长29分51秒)

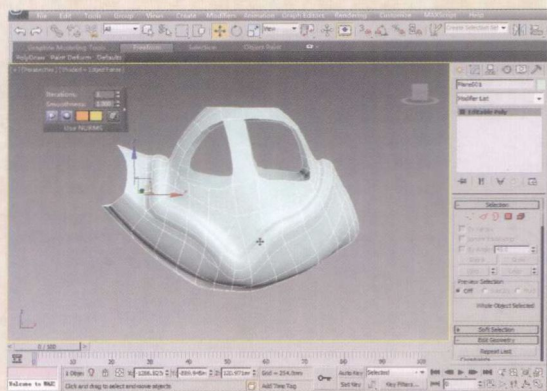

小海龟2 (视频教学时长22分30秒)

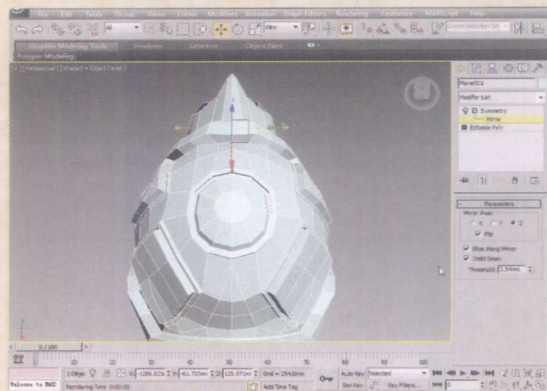

小海龟3 (视频教学时长10分04秒)

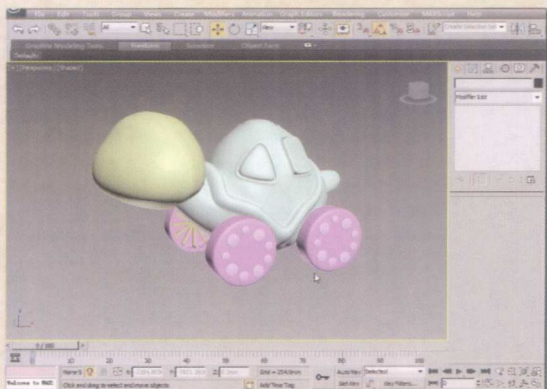

## 第9章

MP4 (视频教学时长15分55秒)

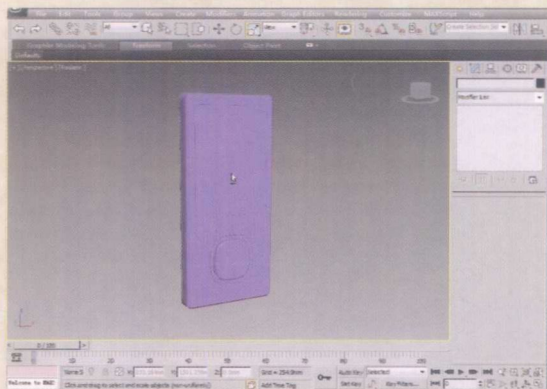

手机1 (视频教学时长42分42秒)

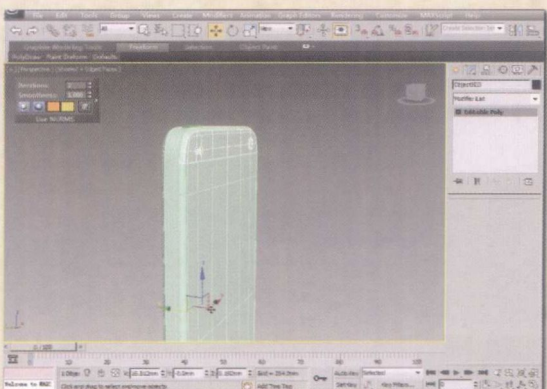

手机2 (视频教学时长29分12秒)

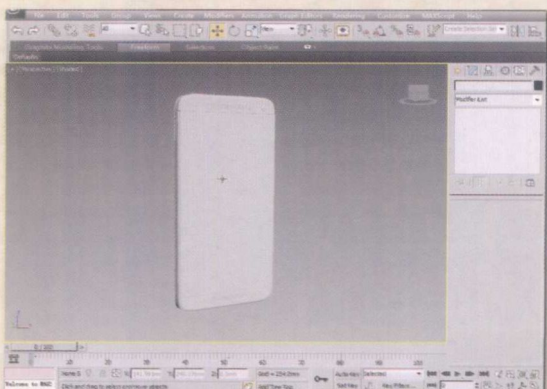

## DVD 02 学习内容

### 第10章

冰箱1 (视频教学时长41分23秒)

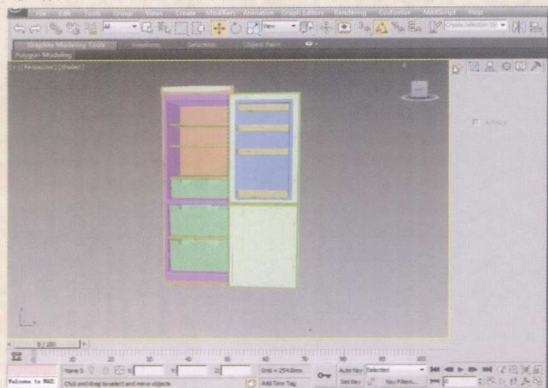

冰箱2 (视频教学时长33分17秒)

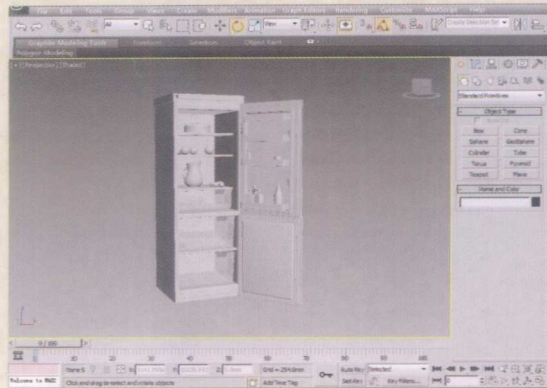

音响1 (视频教学时长32分20秒)

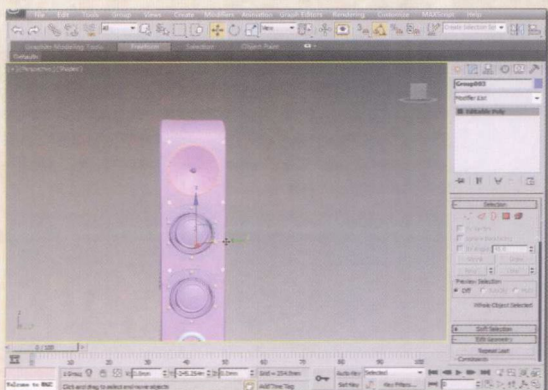

音响2 (视频教学时长44分37秒)

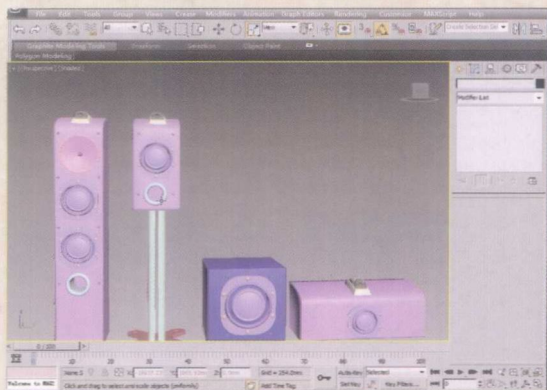

### 第11章

单反相机1 (视频教学时长49分10秒)

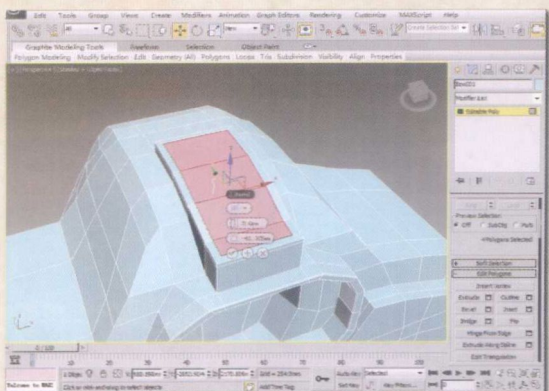

单反相机2 (视频教学时长37分51秒)

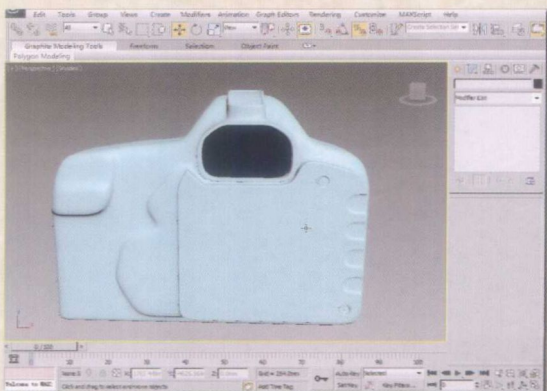

# 3ds Max 工业产品设计高级实例教程

单反相机3 (视频教学时长45分23秒)

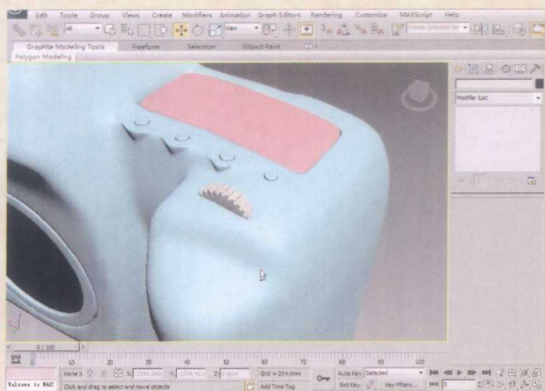

单反相机4 (视频教学时长26分34秒)

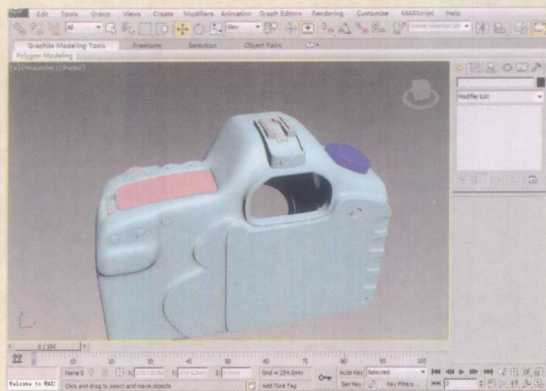

单反相机5 (视频教学时长40分49秒)

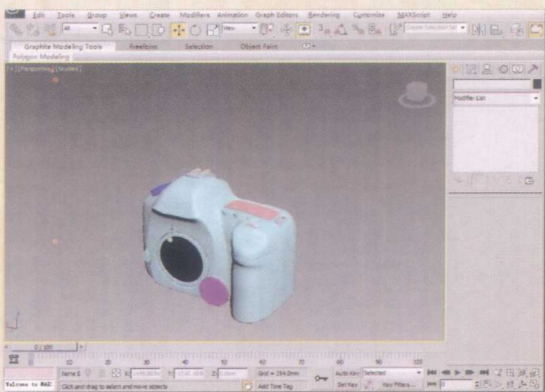

单反相机6 (视频教学时长19分38秒)

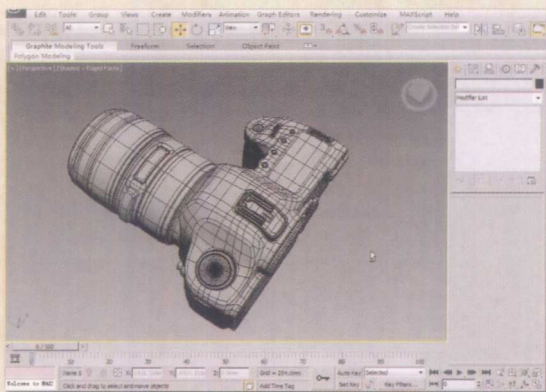

## 第12章

电脑 (视频教学时长32分38秒)

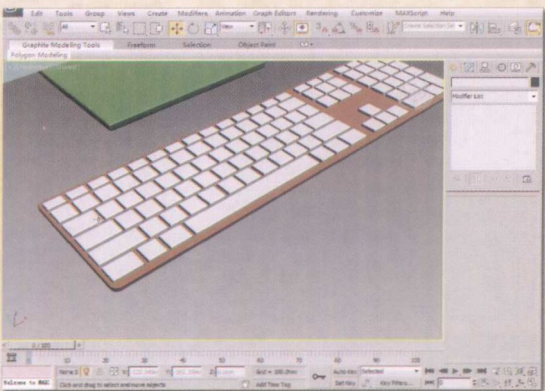

摩托车1 (视频教学时长10分18秒)

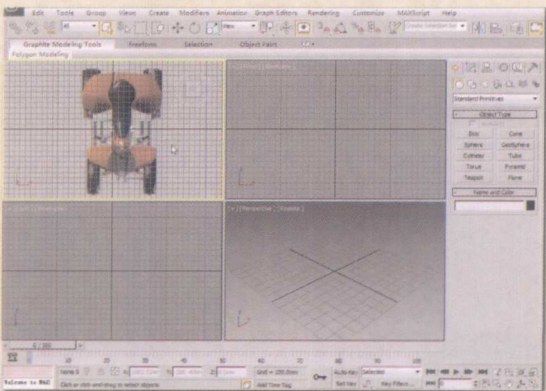

摩托车2 (视频教学时长25分02秒)

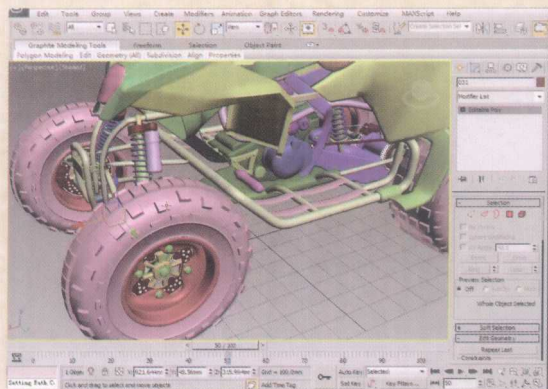

汽车1 (视频教学时长16分04秒)

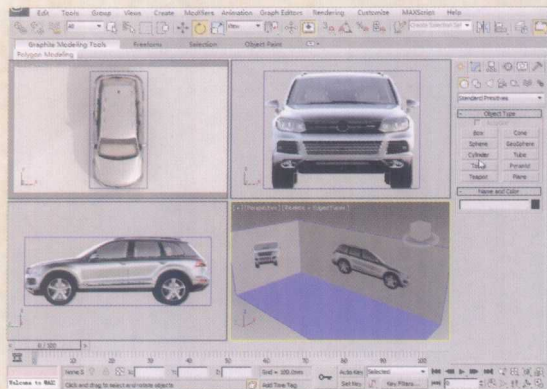

汽车2 (视频教学时长11分41秒)

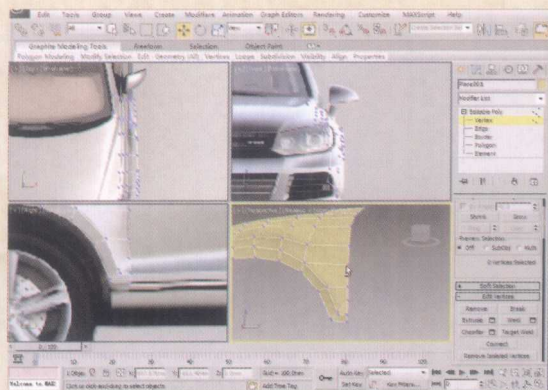

汽车3 (视频教学时长34分30秒)

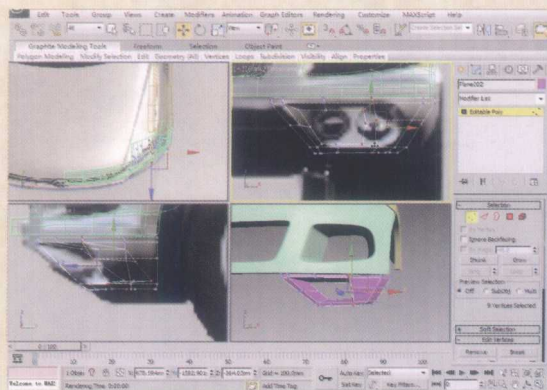

汽车4 (视频教学时长38分28秒)

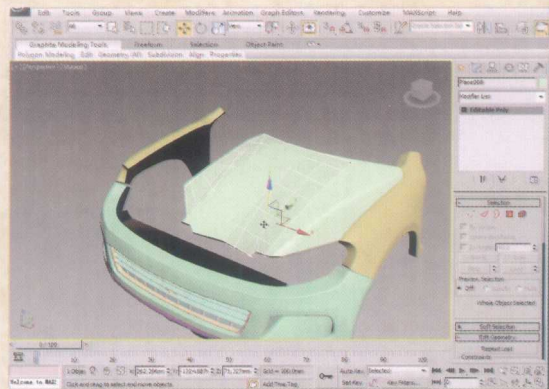

汽车5 (视频教学时长19分17秒)

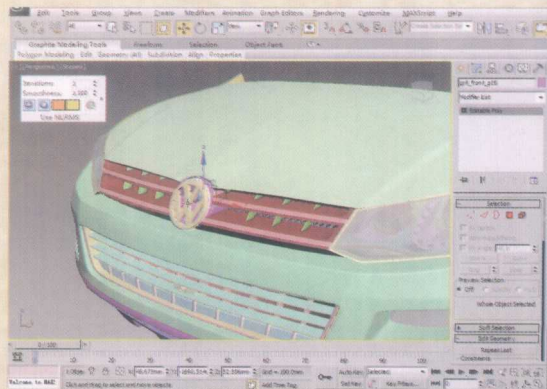



汽车6 (视频教学时长33分14秒)

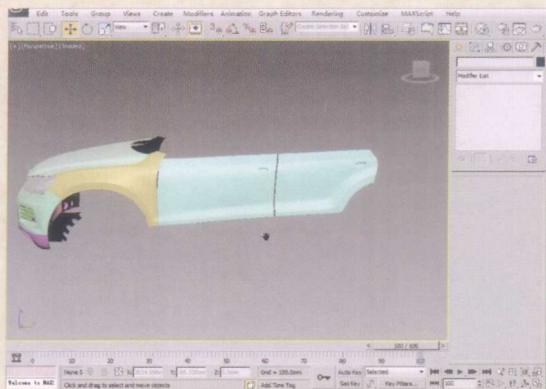

汽车7 (视频教学时长30分51秒)

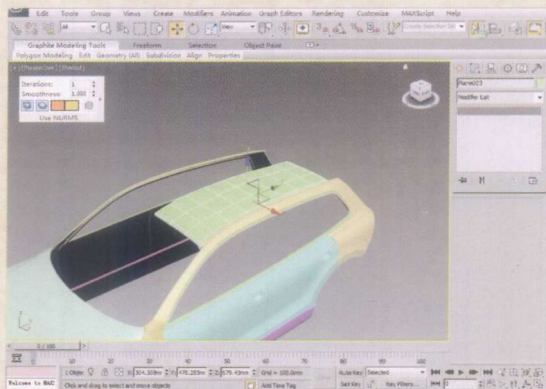

汽车8 (视频教学时长30分33秒)

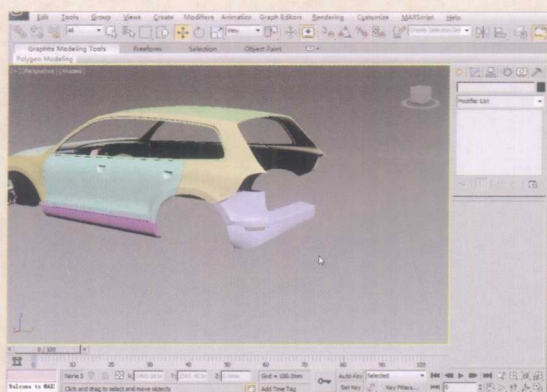

汽车9 (视频教学时长33分55秒)

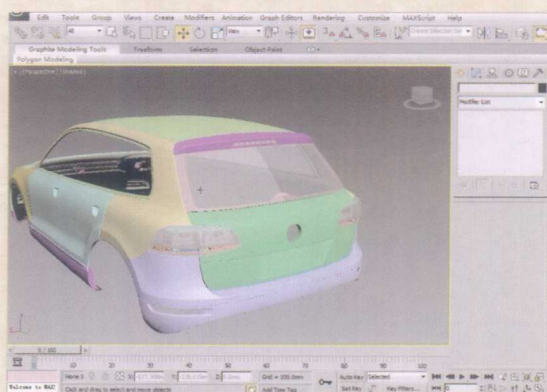

汽车10 (视频教学时长22分45秒)



汽车11 (视频教学时长17分27秒)

