

东西方各俱特色 多姿多采

85款裁剪图解 实用方便

0090171



史小娟 李丹 张吉成 岳晓纹 编

# 最新流行时装 120款

ZUIXIN

SHIZHUANG

LIXING



# 序言

本书精编日本、法国有代表性的流行时装120款。内容以春、夏、秋为主。所编款式新颖大方，融东西方不同风格之特色。其中有：时装套裙、连衣裙、风雨衫、简便有魅力的盛夏合身裙、新颖迷人的校园服以及海滨装、秋季衫等，五彩缤纷、风格各异，具有新奇和雅俗共赏之感。为了提高人们服饰搭配水平，本书以精美丰富的图片和通俗的文字介绍了服装搭配中的色彩和面料间关系，图文并茂，具有较高的欣赏和应用性。

本书在编排形式上令人耳目一新，同时每种款式都配有详细的裁剪方法图，诚望这些款式能给女士们带来春天般的喜悦，并经您巧装打扮而更加魅力迷人。

1989年·秋

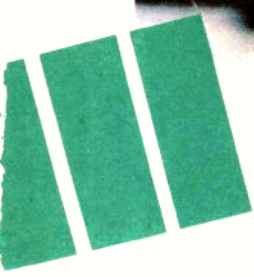





2

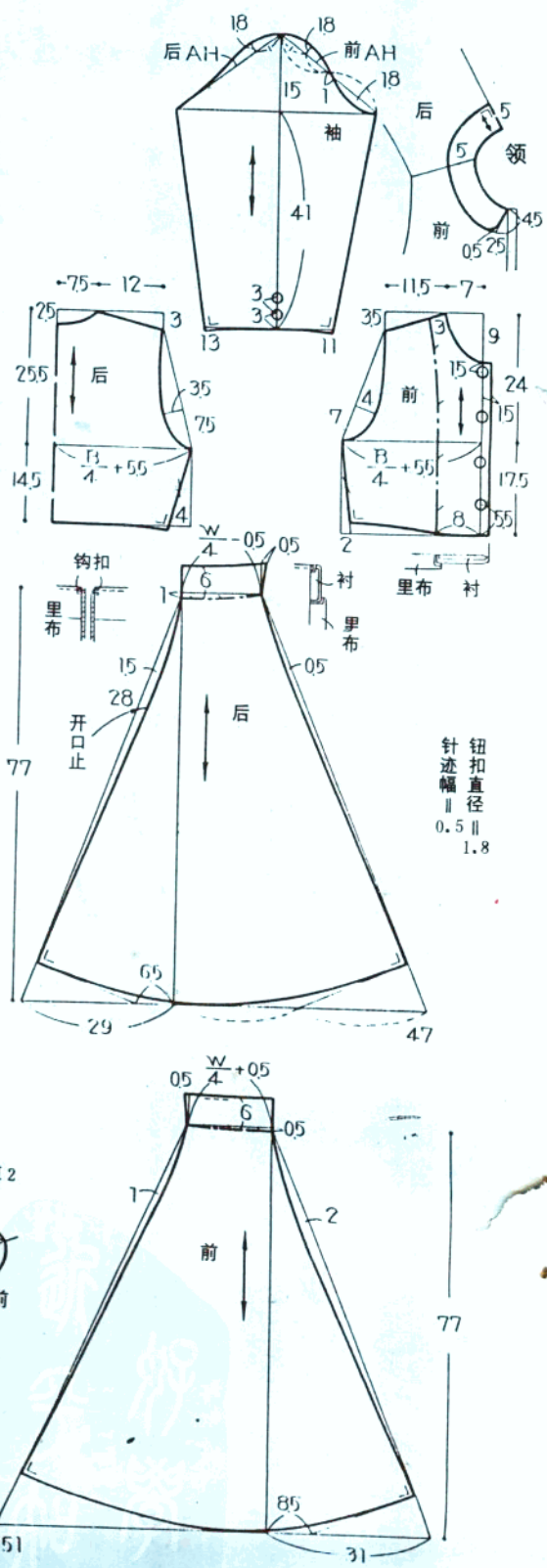

钮扣直径  
|| 0.5 ||  
|| 1.8 ||

材料：条纹绸缎(绵100%)92cm幅S  
 尺寸3.90cm, M尺寸4 M, L尺寸4.10M,  
 里布90cm, L尺寸1.30(裙)粘结芯90cm  
 幅0.6m(贴边、领)钮扣1.5cm 6个, 1.2  
 cm 6个, 拉链长25cm 1条, 钩扣1组,  
 垫肩1组, 按扣1组。

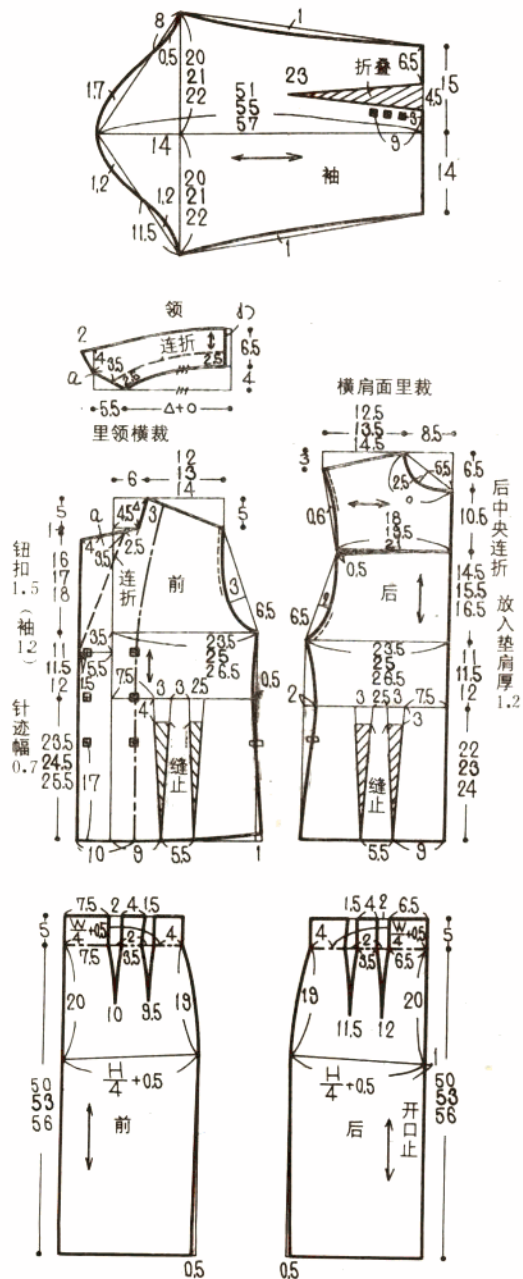

材料: 面料 (聚酯多效培夫绸) 110 cm 幅 2.80 m, 另布 (珠罗纱条带) 110 cm 幅 90 cm, 粘结芯少量 垫肩 1 组, 拉链 1 条, 钩扣 2 组, 饰针 1 支。

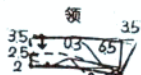
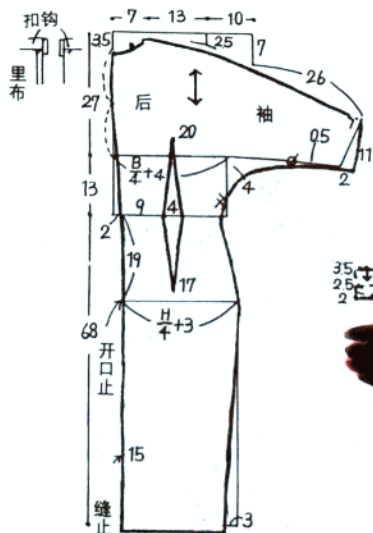

针迹幅 0.2

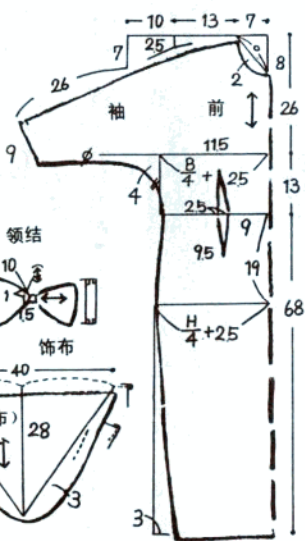

领结



饰布

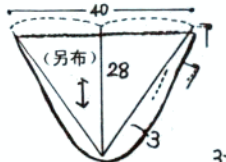

贴边

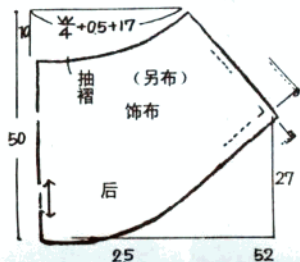
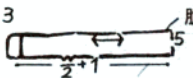

垫肩

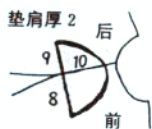

4







❁ 5

6

59





# 7

●材料：涤纶幅宽90cm、长3.3m、黑布幅宽90cm、长1.6m(裙子)，粘合衬幅宽90cm、长0.6m(前身里、贴边、腰带)、扣1.5cm 8粒、包布皮带扣1个。

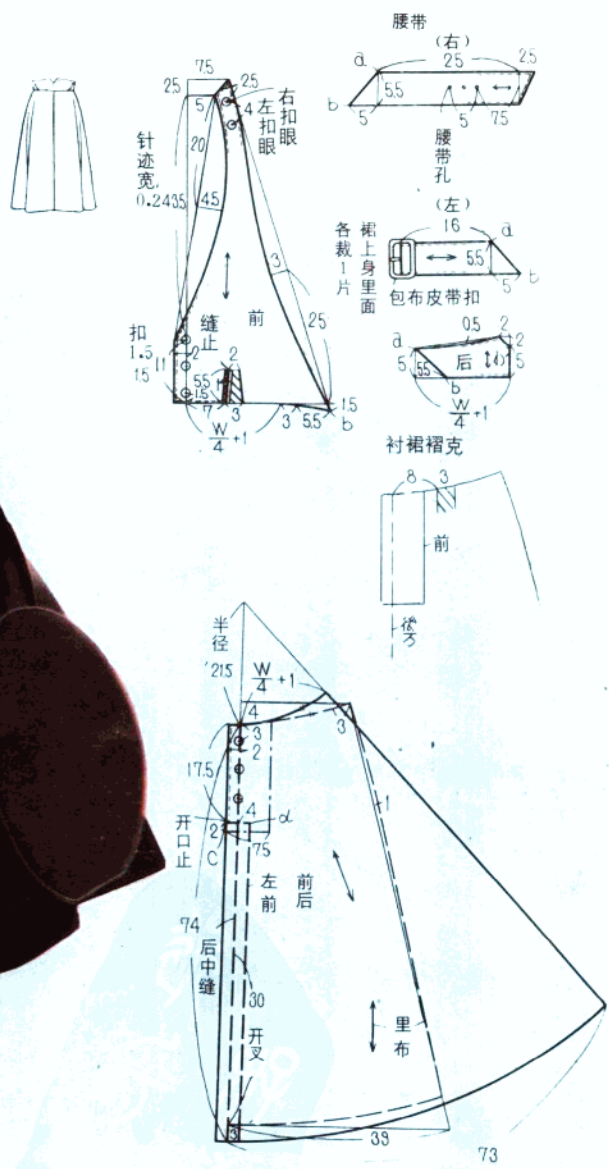





8

53

华贵，优雅，做工考究，可称高级  
时装。变化的下摆，具有赏心悦目的旋  
律美。珍珠般的项链，鲜花一束，同类  
色胸花，相得益彰，令人耳目一新。



9



10

71

11

65







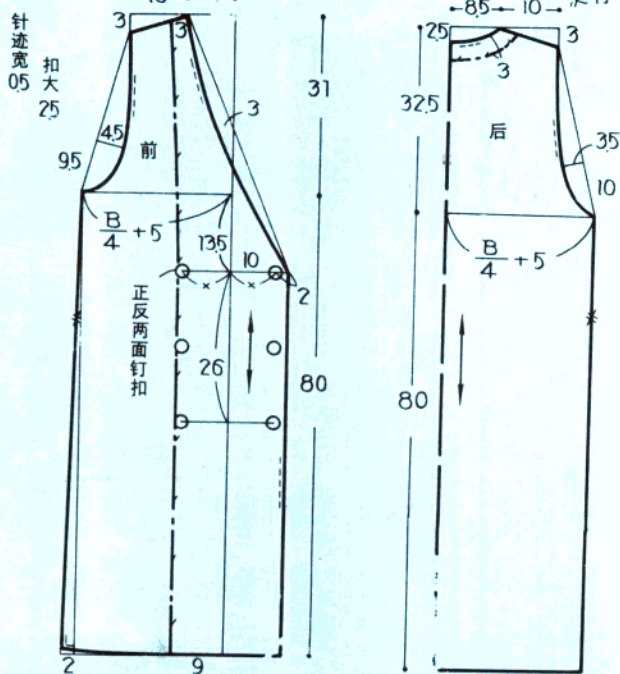

14

●此款端庄大方，色彩雅致，款式以简洁利落为特色，领、袖、下摆及长度都可变化。此装适于中年女性。



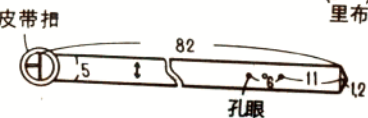
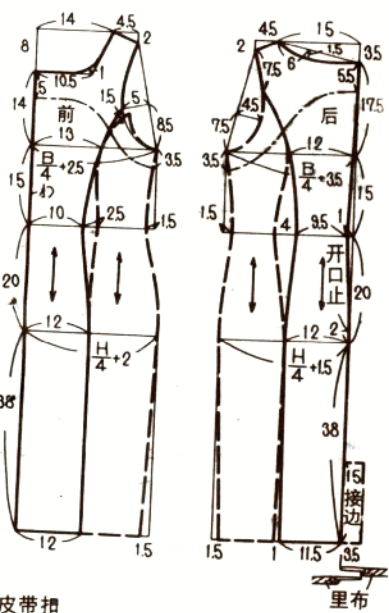
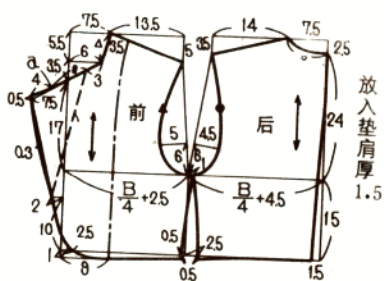
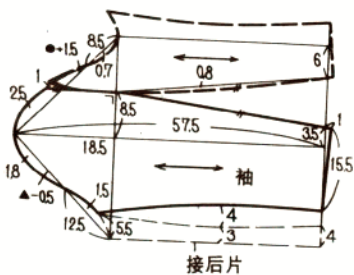
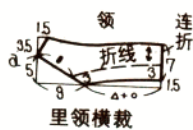

15



17  
60



18  
66



16





材料：面料毛乔其纱(绉)150cm幅1.70m，  
 另布(毛乔其纱)150cm幅1.10m，里布90cm幅  
 2.70m，粘结芯90cm幅30cm，垫肩1组，拉链  
 1条，钩扣2组，安全别针1个，绉纹布少量。

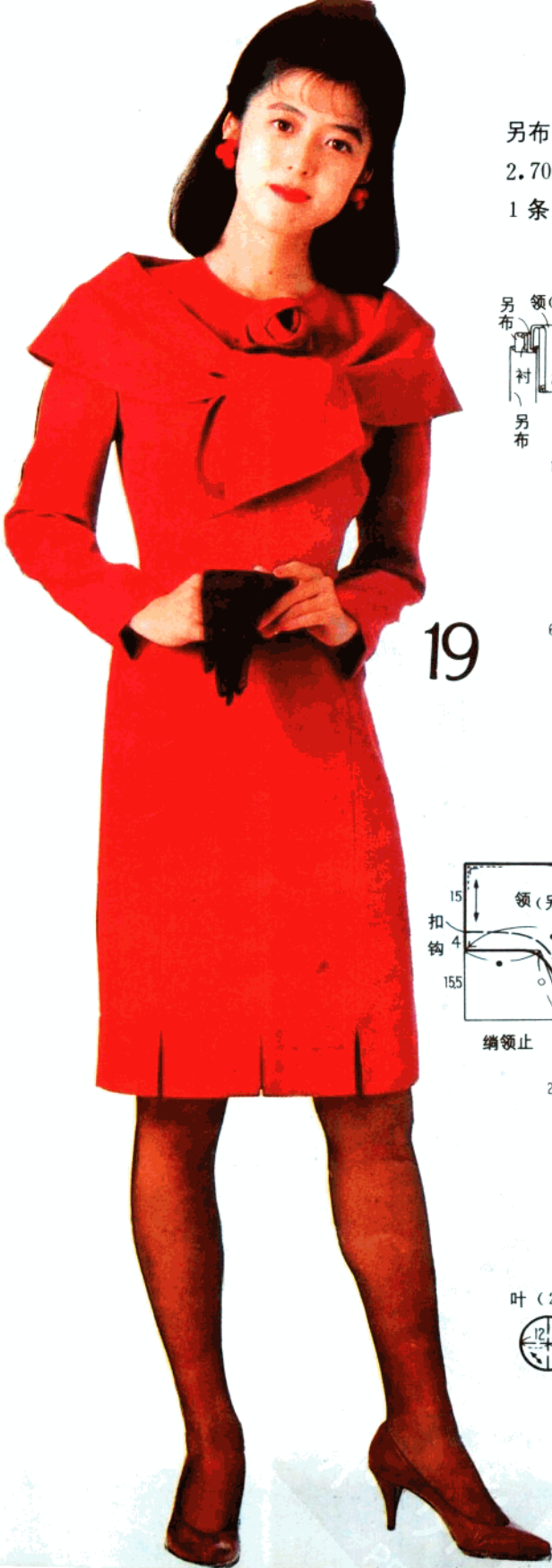

19

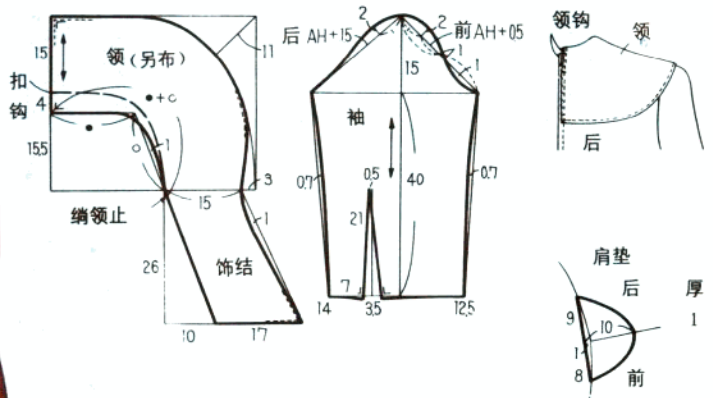
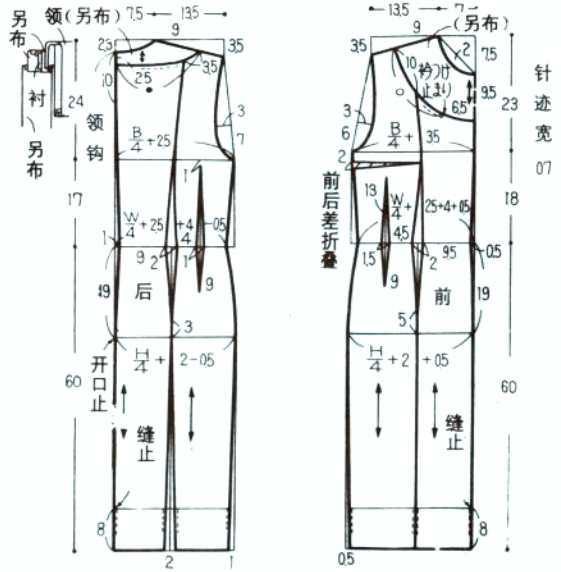

花瓣A (2片)



抽褶 (另布)

花瓣B (3片)

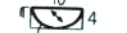

抽褶

叶 (2片)



完全别针 (里布)



材料：面料(安哥拉平针毛料)150cm 幅1.80m，里布90cm 幅1.70m，粘结芯90cm 幅60cm，钮扣1.6cm 5个，垫肩1组，2.5cm 幅松紧带1条。

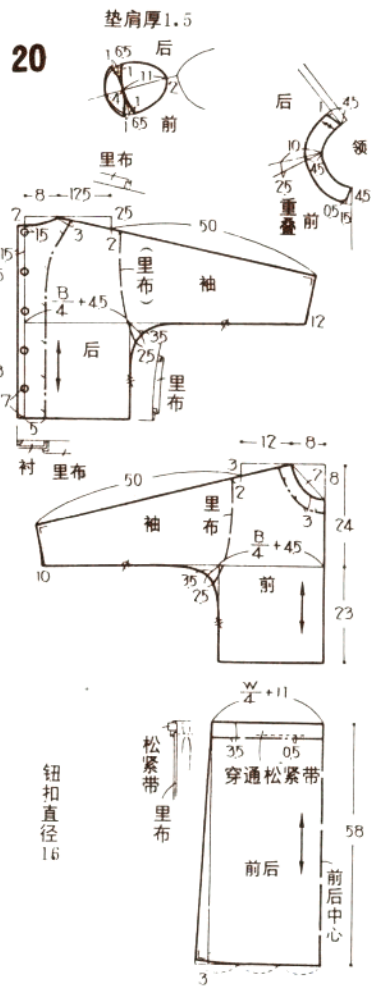



· 21

57



22  
87