



实用家具

山西人民出版社

实用家具

山西省二轻工业厅
山西省标准局 编
太原市二轻工业研究所

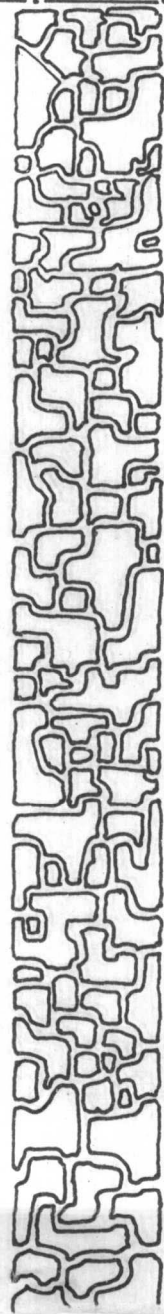
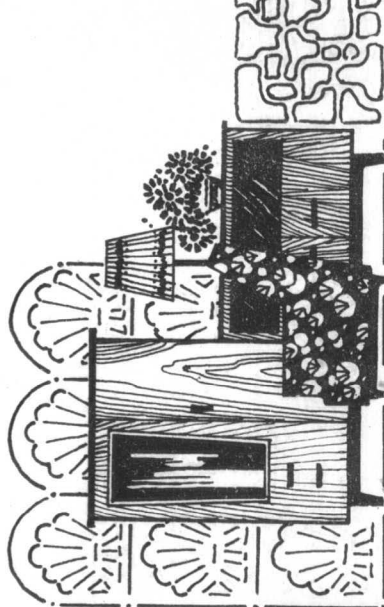



山西人民出版社出版 (太原井州路七号)

山西省书店发行 山西省美术印刷厂印刷

开本: 787×1092 1/16 印张: 10.5 图数: 150幅

1983年8月第1版 1983年8月太原第1次印刷

印数: 1—90,000册

书号: 15088·152

定价: 一元八角

前 言

随着我国人民生活的不不断提高，人们对家具的造型、结构、表面装饰及实用性能等方面的要求越来越高。为了适应家具行业及家具业余制作者的需要，实现家具标准化，我们从国内外搜集了部份式样新颖、美观大方、结构合理、既实用又舒适的新家具资料，还从我省家具生产厂家选择了部份深受用户欢迎的优秀产品造型，设计编辑了这本《实用家具》图谱，供家具制作者参考。

本图册包括：卧室家具彩页二幅，板式家具图七幅，组合家具图九幅，卧式家具图廿三幅，综合家具、客厅家具、餐厅家具及书房家具廿六幅，国外家具图三幅，国内外家具照片八十张。此外，还编入了家具材料工艺知识、家具装饰图案、国家新标准〈家具〉等家具设计参考资料。考虑到家具制作工作需要，家具图中一般都绘有结构图。

本图册由山西省二轻工业厅、山西省标准局、太原市二轻工业研究所共同组织编绘。在编绘过程中，山西省家具工业科技情报站、太原市二轻工业局、太原市竹木日用品工业公司、太原市木器厂等单位都给予大力协助，在此一并表示感谢。

由于我们水平有限，错误和不妥之处在所难免，敬请广大读者批评指正。

编 者

一九八二年八月

目 录

板式家具	1—8
组合家具	9—18
卧室家具 (一)	19—26
卧室家具 (二)	27—34
卧室家具 (三)	35—44
综合家具	45—54
客厅家具	55—62
餐厅家具	63—68
书房家具	69—74
国外家具	75—98
家具设计参考资料	99—112
中华人民共和国国家标准 (家具)	113—136

(GB 3324—3330—82)

双人床

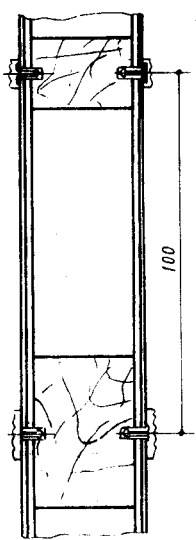
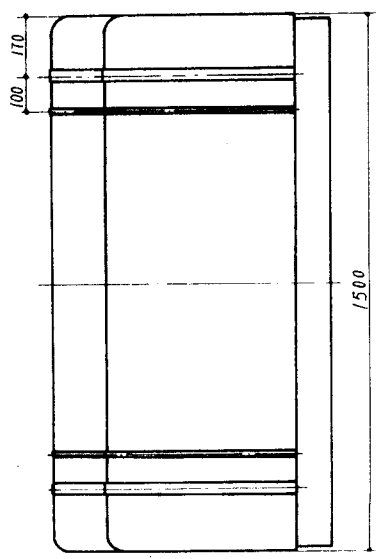
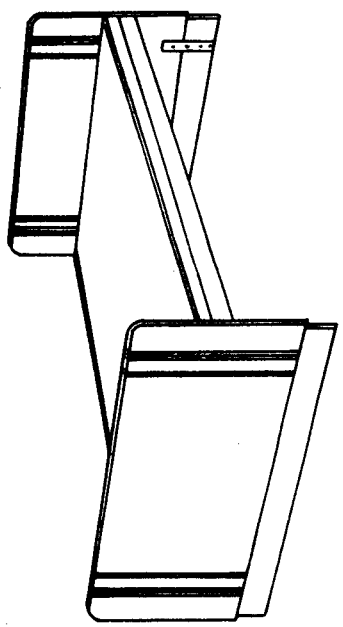
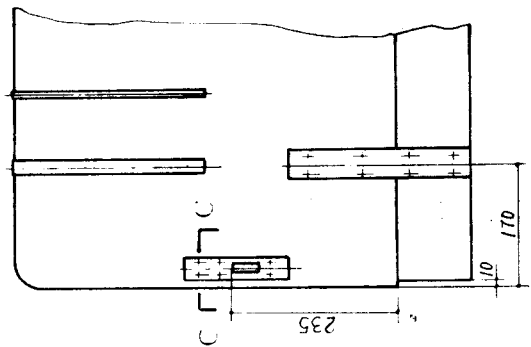
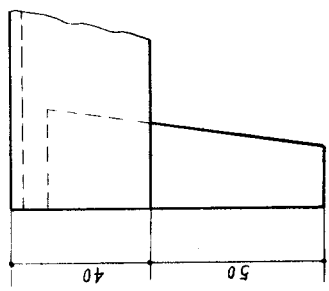
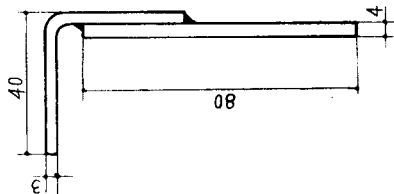
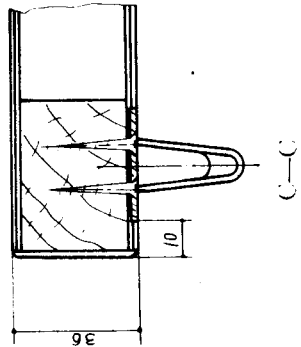
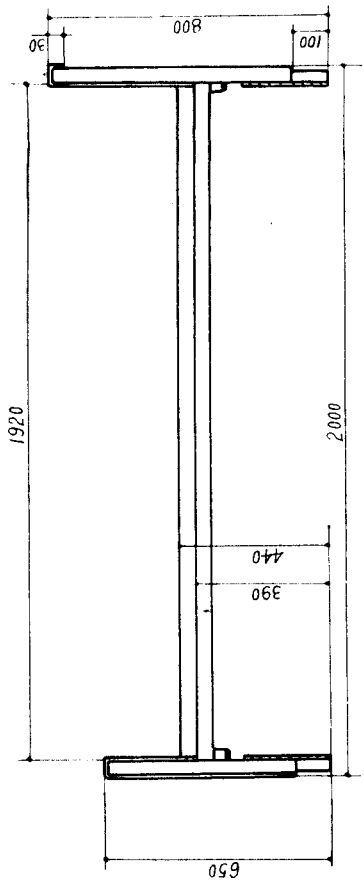

二门衣柜 (一)

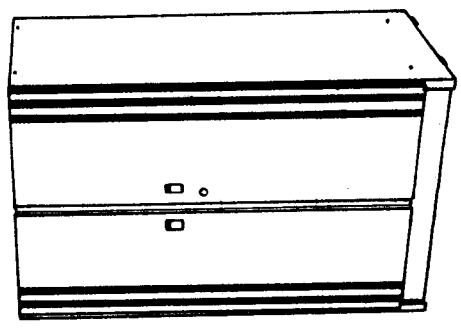
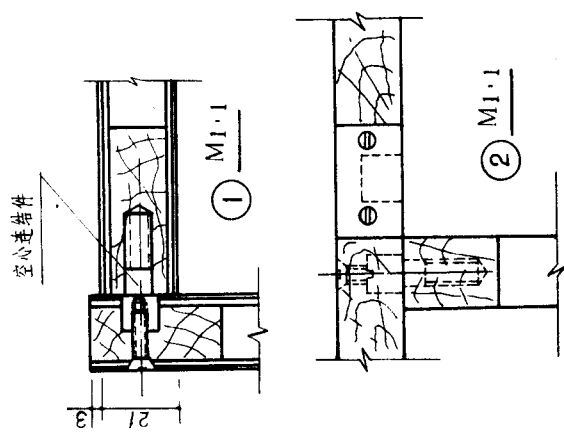
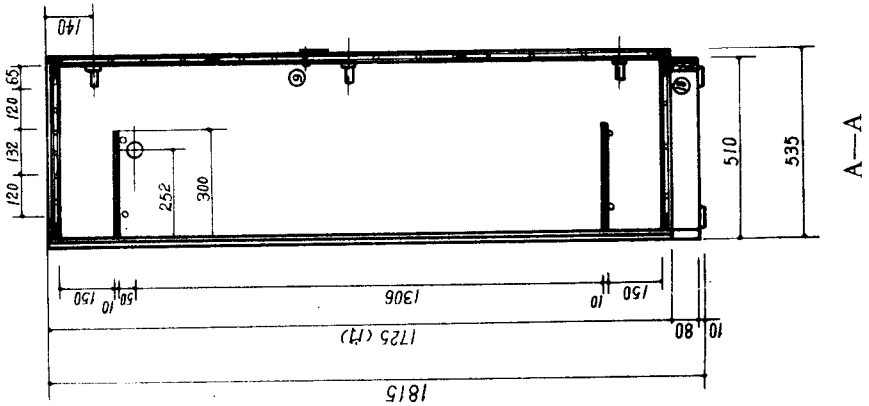
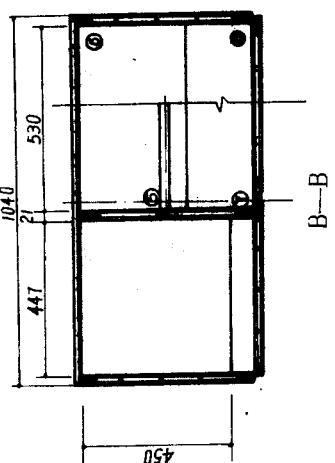
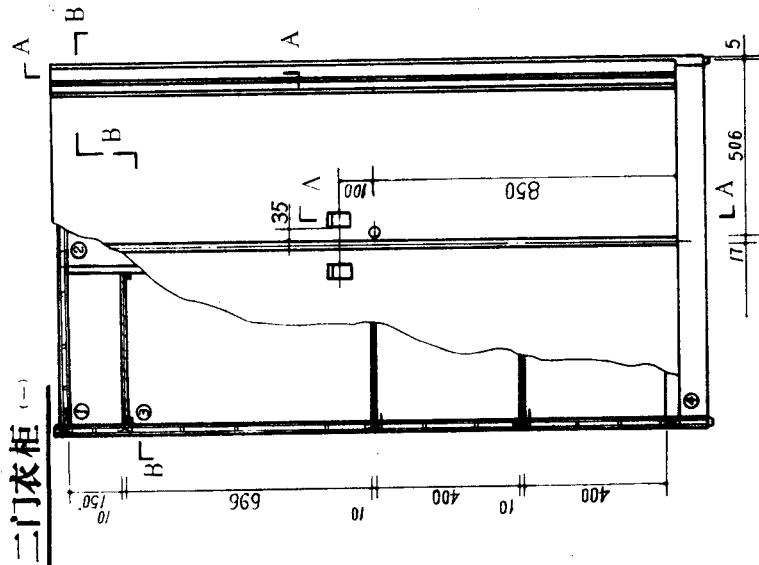

二门衣柜 (二)

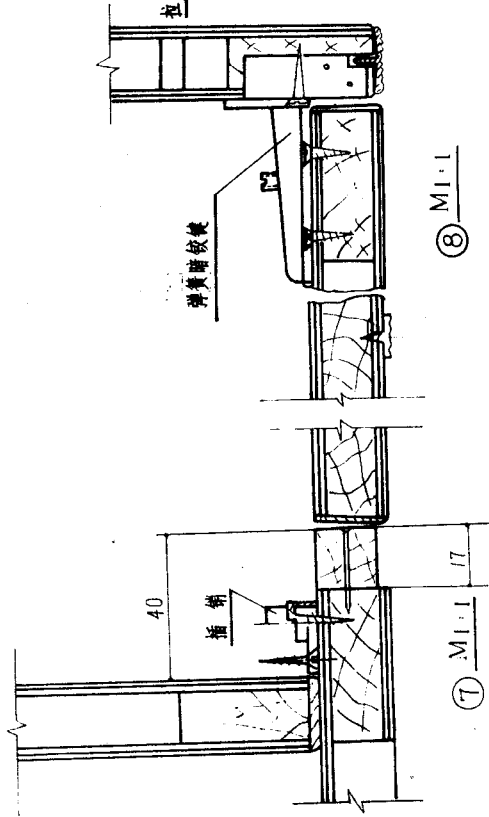
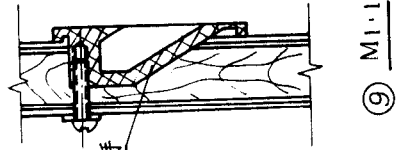
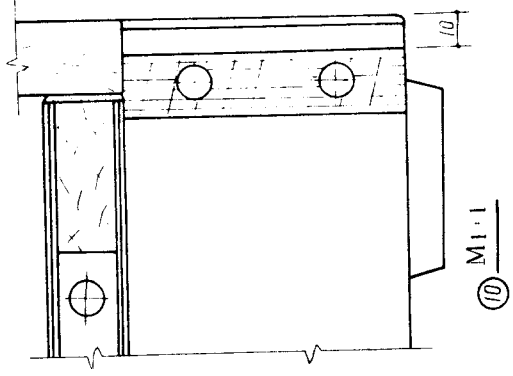
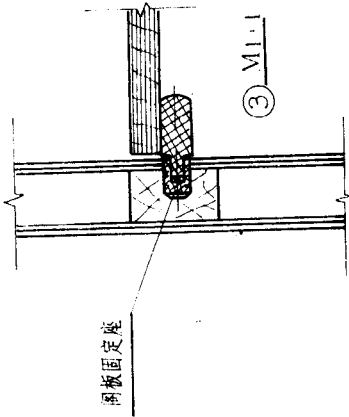
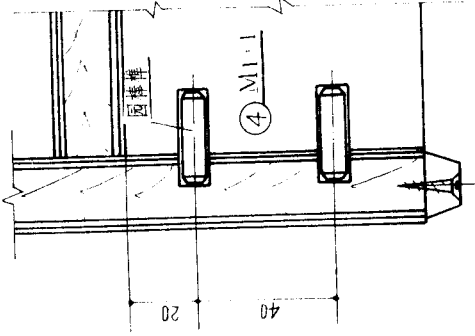
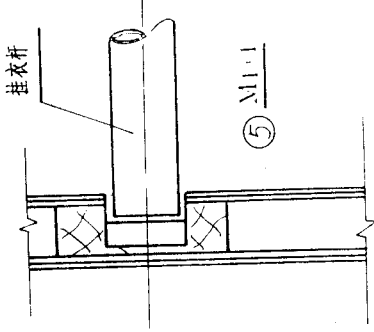
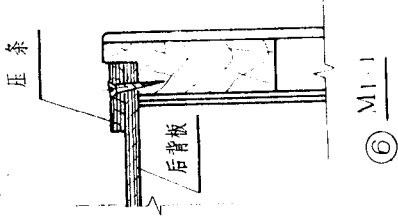

双柜写字台

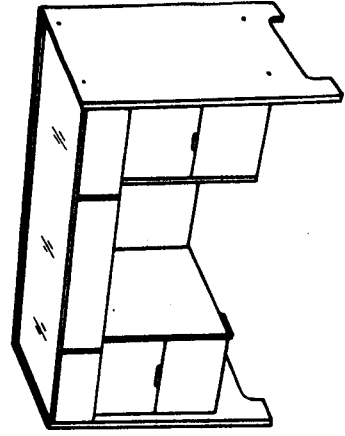
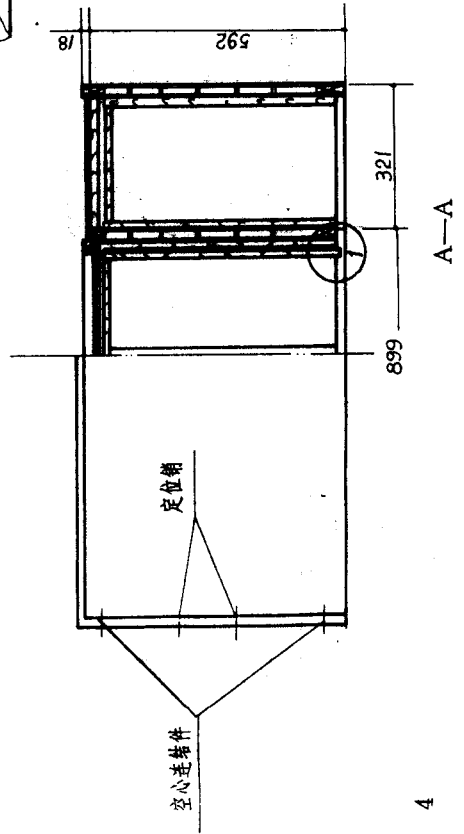
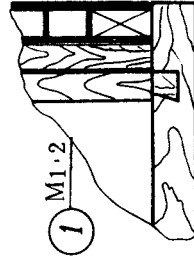
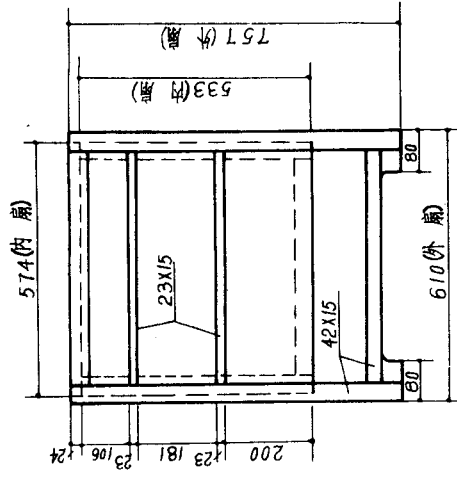
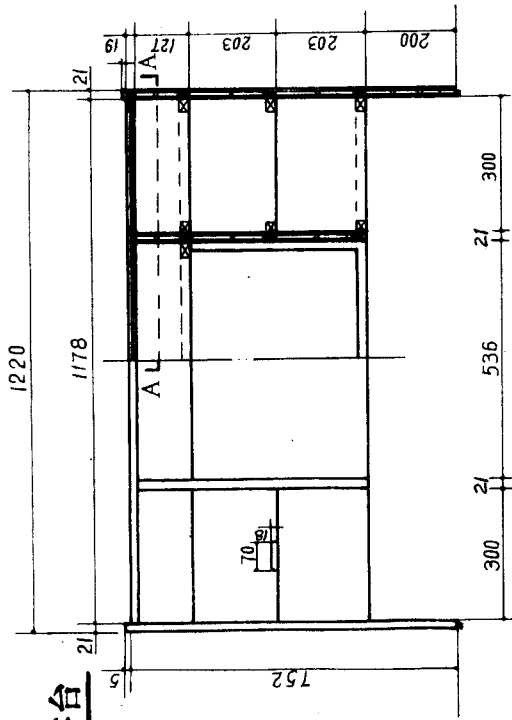

梳妆台

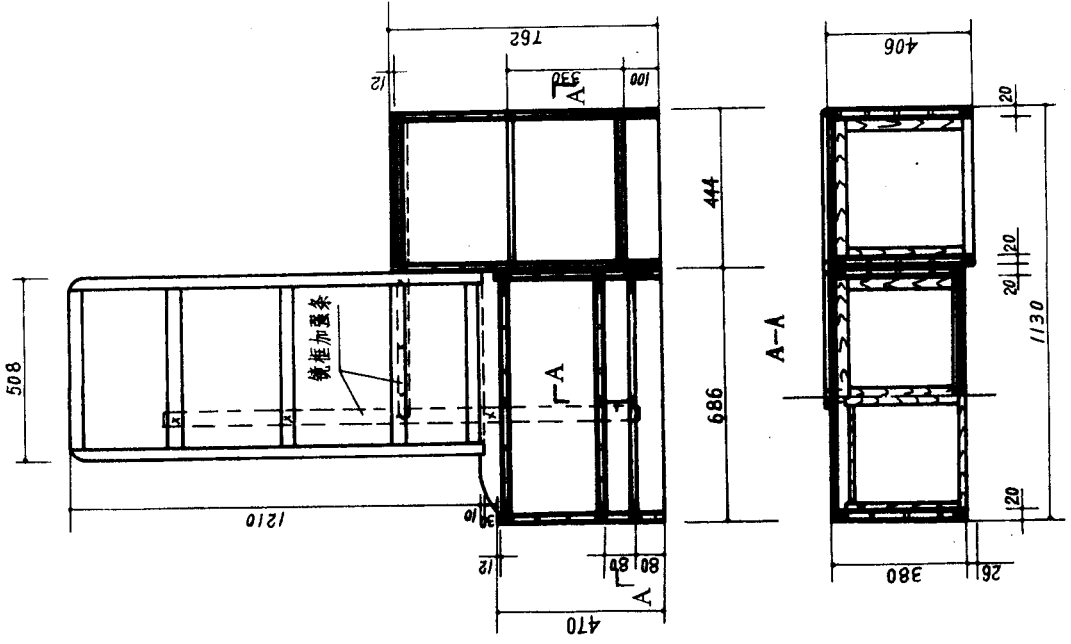
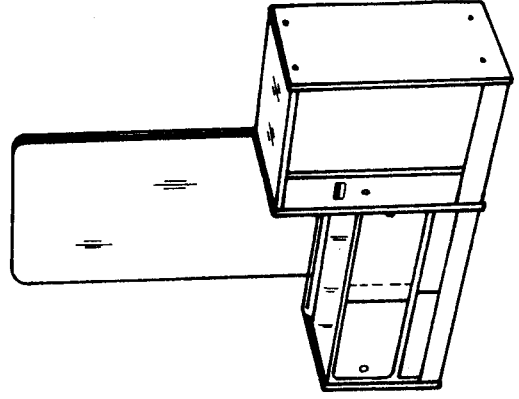
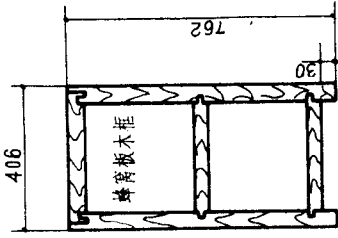

梳妆凳

面料
透米

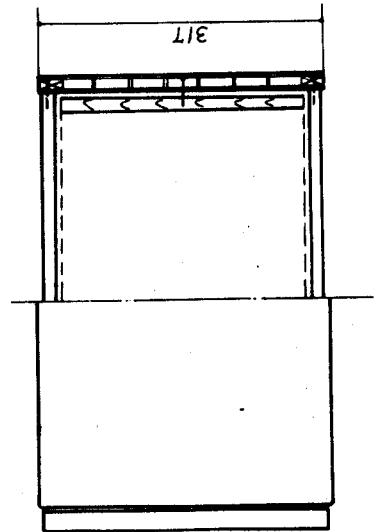
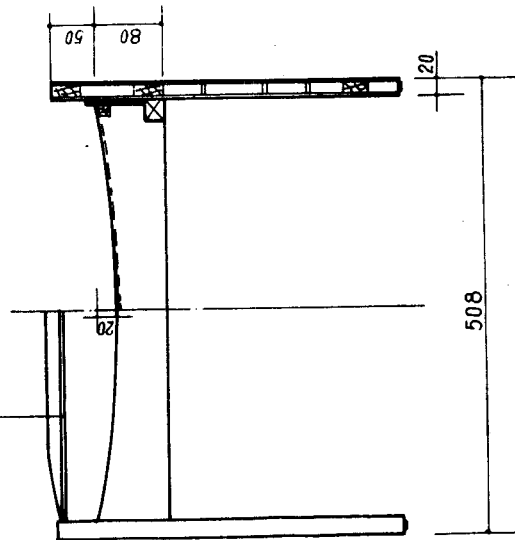
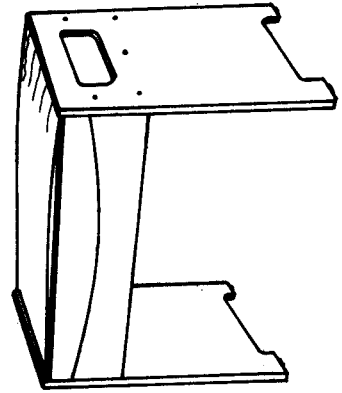
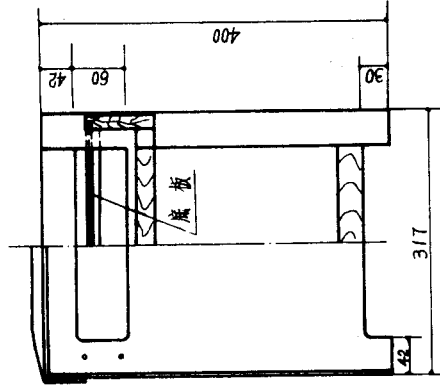

餐柜

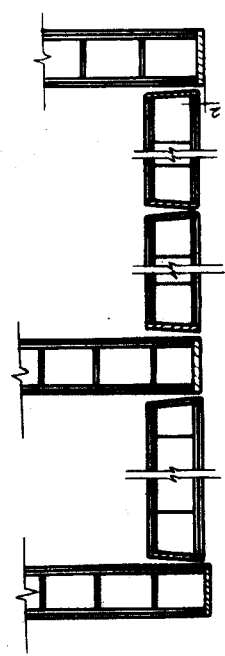
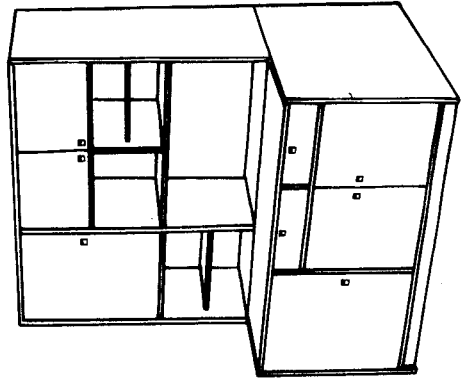
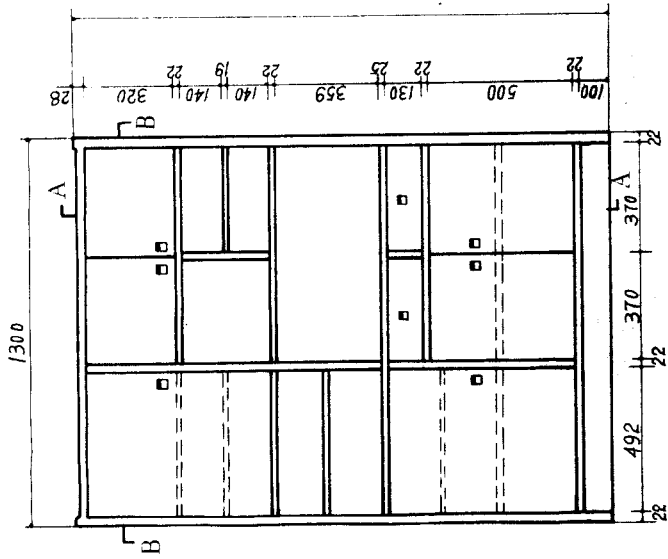
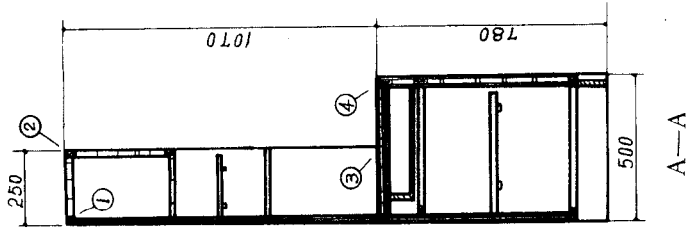
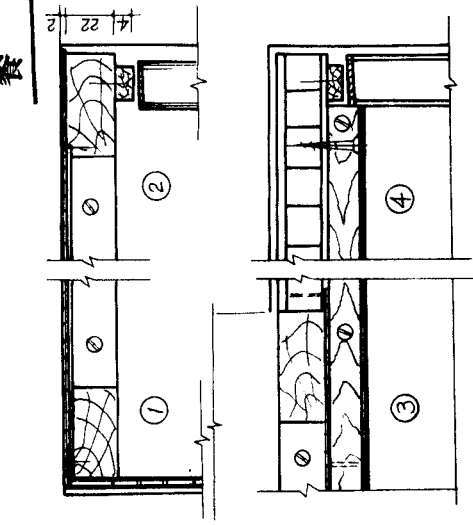

B-B

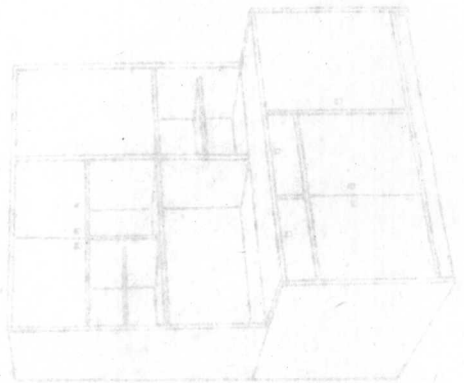
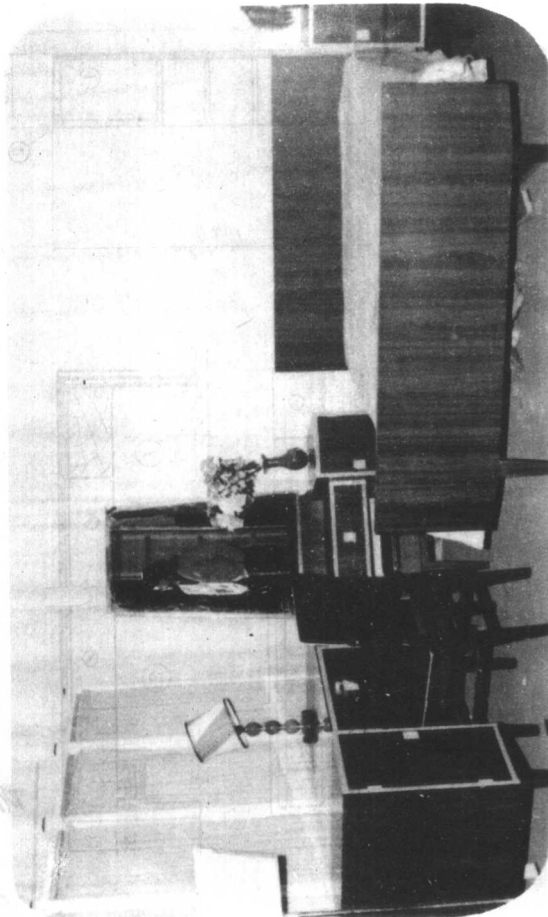
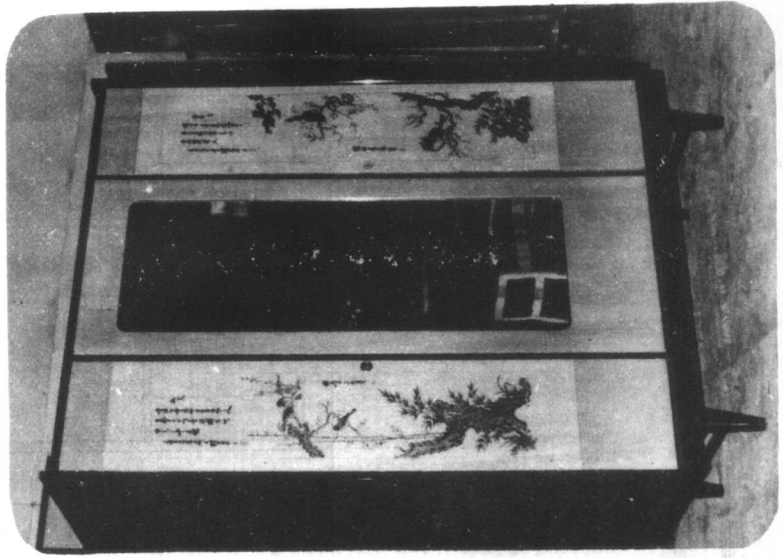

组合柜 (-)

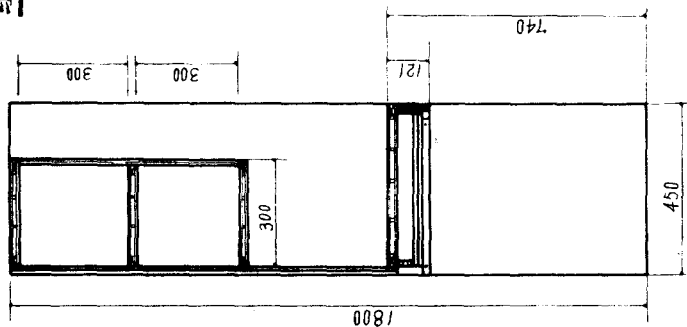

B-b

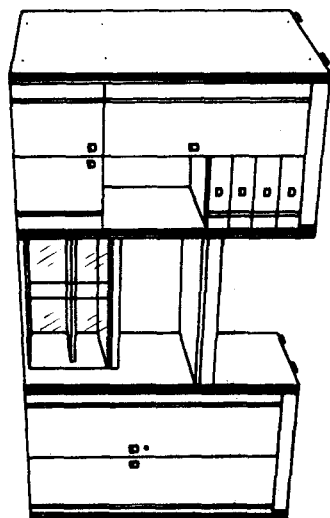

9

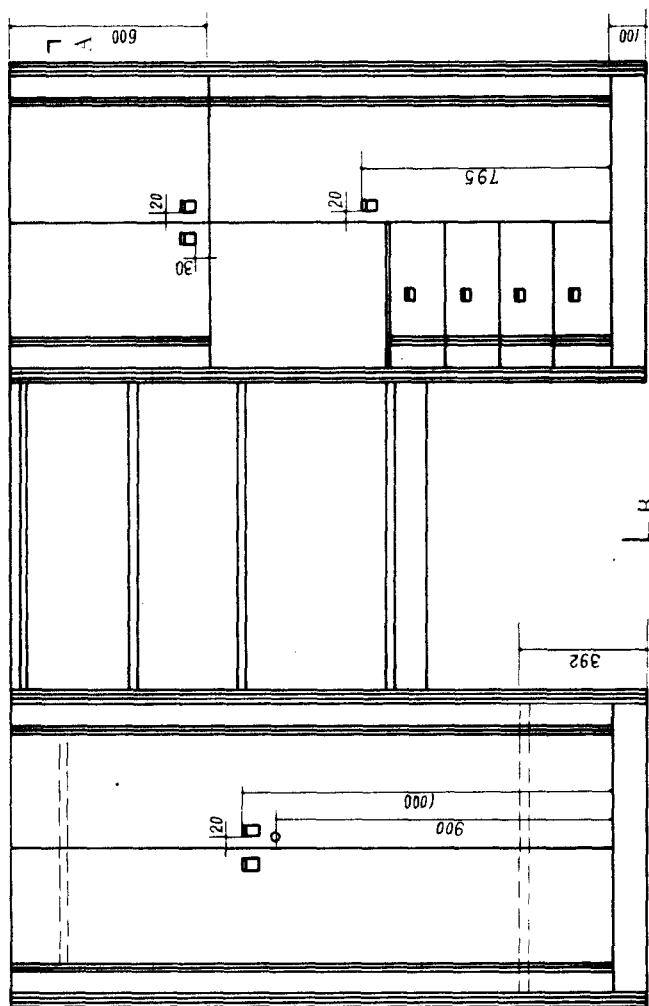

B

B

2784

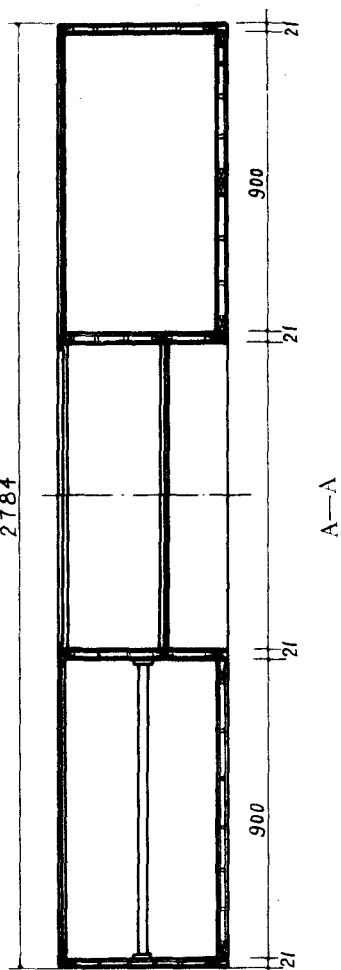

A-A

组合柜 (二)

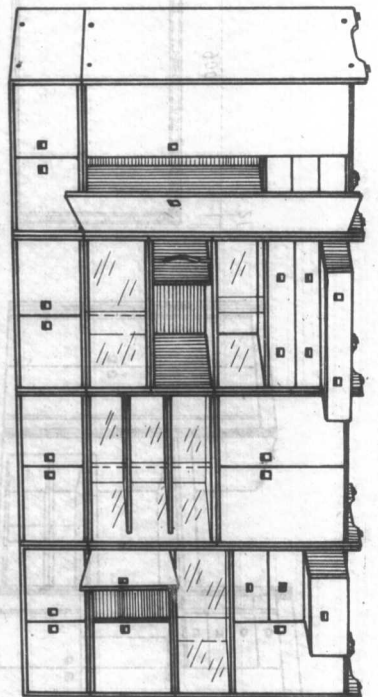
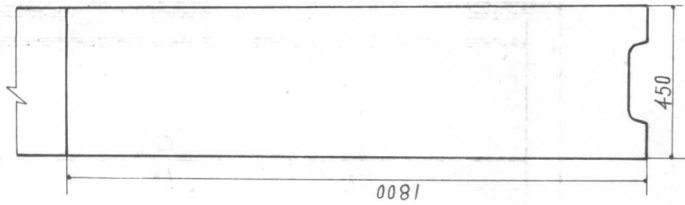

组合柜 (点)

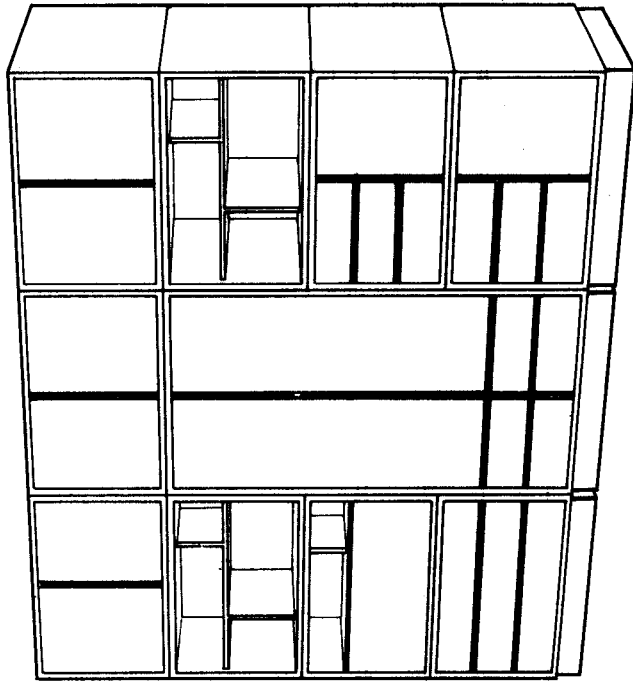
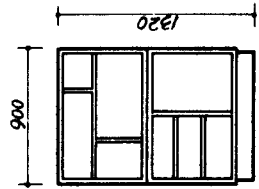
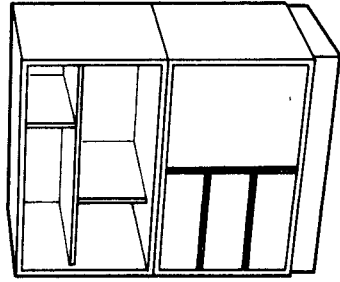
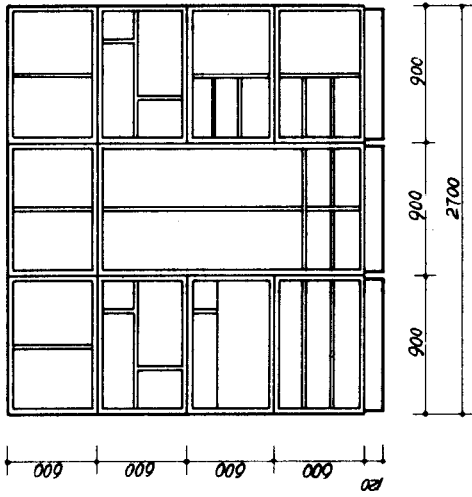

组合柜 (四)

