

英汉对照

科技图解

小词典



# 英 汉 对 照

## 科 技 图 解 小 词 典

李宗慧 储淑萍  
曹吉祥 徐桂琴

译 漆平生 校

中国科学技术翻译出版社

Evans Technical Dictionary

Evans Brothers Limited 1982

英汉对照

科技图解小词典

李宗慧 储淑萍 曹吉祥 徐桂琴 译

漆平生 校

中国科学技术翻译出版社出版

(北京朝内大街137号)

北京市新华书店发行

人民美术印刷厂印刷

1984年7月第 1 版 737×1092毫米 1/32

1984年7月第 1 次印刷 印数6

印数001—30000 字数15万字

书号17242·002 本社书号000·002

定价：1.20元

## 前 言

为了帮助技校学生和厂矿职工以及其他科技人员学习英语和阅读初级英语科技读物，我们翻译了这本“伊万斯技术词典”(Evans Technical Dictionary)，以“英汉对照科技图解小词典”的名字出版。

本词典收录科技名词1000条，每个词汇下边给以简明释义，释义所用的英文字限制在大约2000个最常用的单词。书末编有“国际制单位”、“英制单位”等附录。

由于译者水平有限，经验不足，错误之处欢迎读者批评指正。

1983年1月

## 使用说明

1. 本词按英文字母顺序排列, 用黑正体印刷, 同一本词的不同词义以 1, 2, 3……分列, 译文的不同词义在右上角标以角码。
2. 本词、释义、图中文字及附录部分均以英汉对照排列。
3. 英文释义中的“\*”号表示该词将在本词中出现, 中文对照以黑体字; 英文以斜体排出的科技名词, 中文对照以楷体字。
4. 对同一器物, 英、美文字不同而中文译文相同者, 译文保留美语原文。

## 目 录

前言·····	iii
使用说明·····	iv
词典正文·····	1—160
附录·····	161

# A

**abrasive**, a substance used to rub or grind down a surface; e.g. sand, \*emery, carborundum.

**磨料**: 一种用来抛光或磨蚀一个表面的物质。例如砂、金刚砂、碳硅砂。

**abrasive disc**, a disc coated with an abrasive for rubbing or grinding down a surface. It is usually turned quickly by an electric hand drill.

**砂轮**: 敷有磨料用于抛光或磨蚀一个表面的一种圆盘。通常可由一个手扶电钻来带动作快速旋转。



**a.c.**, see alternating current.

交流的缩写: 见交流。

**accelerator**, the pedal that increases the speed of a car or other vehicle. *U.S. name gas pedal.*

**加速踏板**: 加快汽车或其他车辆速度的踏板。美国称作 gas pedal。

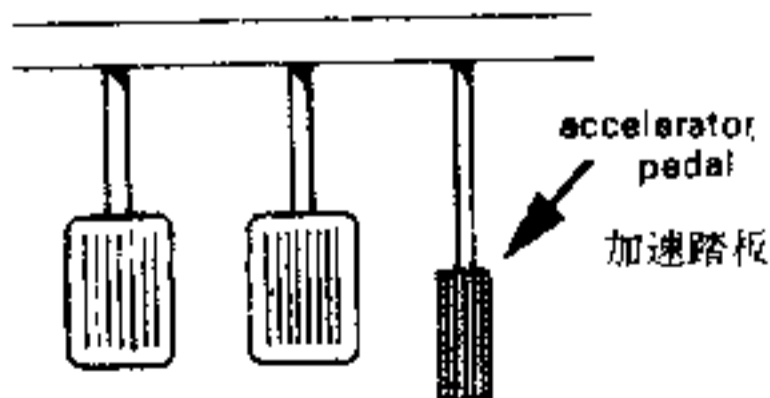

**accumulator**, a device for storing electricity consisting of one or more electric \*cells. An accumulator can be recharged by passing a current through it. The battery in a car is a type of accumulator. *Also called (especially in the U.S.) storage battery.*

**蓄电池**: 由一个或多个电池组成用以贮存电力的一种装置。可以采取使电流在其中通过的办法来对蓄电池重新充电。汽车中的电池组就是蓄电池的一种类型。蓄电池也称(特别在美国) storage battery。

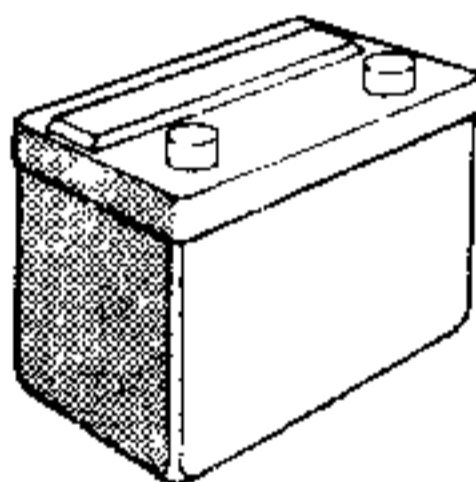

**acute angle**, see angle.

锐角: 见角。

**adapter**, a type of electric plug used to join a number of plugs to one socket.

**连接器**: 用来把许多插塞连接于一个插座的一种电路插头。

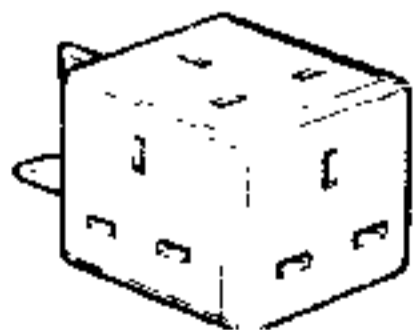

## adhesive

**adhesive**, a substance used to stick surfaces together; e.g. \*glue, cement.

**粘合剂**: 一种把两个表面粘合在一起的物质。例如**骨胶**和**水泥**。

**adjustable spanner**, a type of \*spanner that can be changed in size. Adjustable spanners can be used with nuts of different sizes. See also wrench.

**活动扳手**: 一种可以改变扳口大小的**扳手**。

活动扳手可用来扳拧不同尺寸规格的螺母。

亦见**扳钳**。

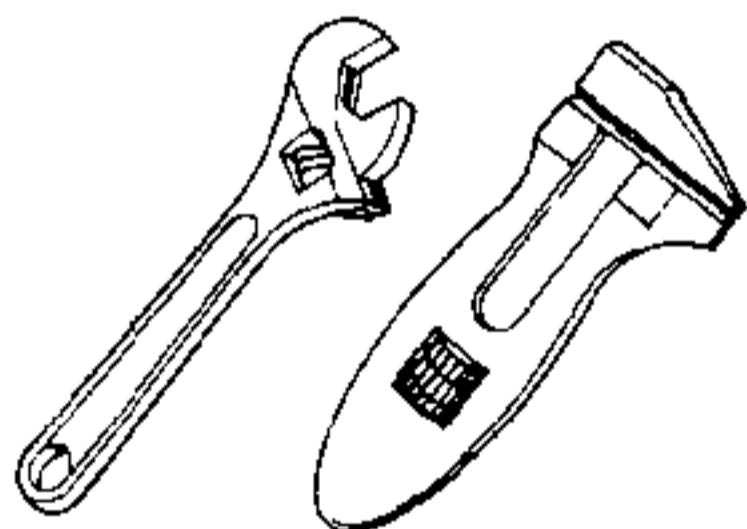

**adze**, a tool used to cut wood. The blade of an adze is joined at right angles (cross-ways) to the handle. *U.S. spelling adz.*

**镑子**: 一种用于砍削木头的工具。镑子的镑头与手柄呈直角地（交叉地）相连互接。美国拼法为adz。



**aerial**, a wire or metal rod or frame used to send out or pick up radio waves. Also called (especially in the U.S.) antenna.

**天线**: 一种金属线、金属棒或金属框架，用来发射或接收无线电波。也称antenna（特别在美国）。

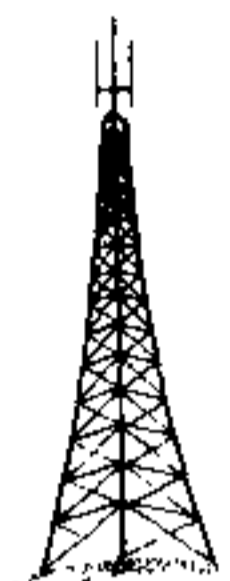

transmitting  
aerial  
发射天线

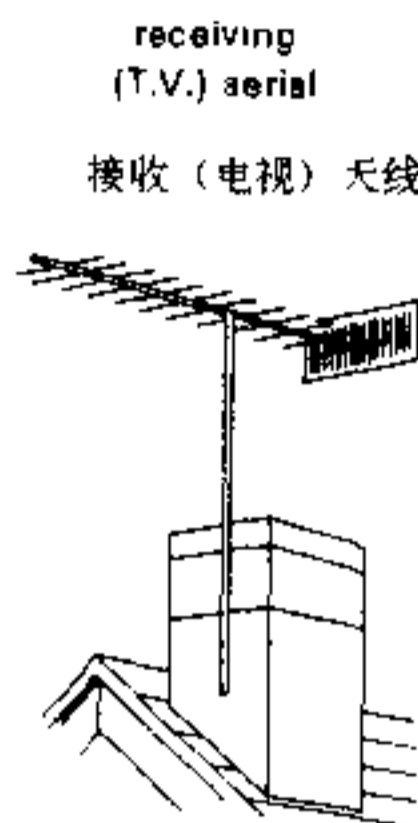

receiving  
(T.V.) aerial

接收（电视）天线

**aerosol**, 1. a fine spray of drops of liquid. 2. a can for producing a fine spray of paint, polish, etc.

**气溶胶**<sup>1</sup>; **按钮式喷雾器**<sup>2</sup>;

1. 一种很细的液滴雾。

2. 一种用来产生油漆或抛光剂细雾的罐子。

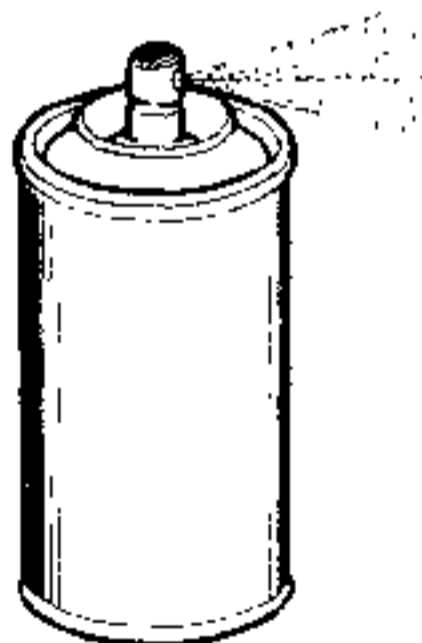

**air brake**, a type of vehicle \*brake worked by compressed air.

**空气制动器**: 一种用压缩空气来操纵的车辆制动器。

**air-cooled engine**, any \*engine that is cooled by a flow of air only (i.e. not by a flow of water).

**气冷式发动机**: 任何一种仅用空气流来冷却的(亦即不用水流来冷却的)发动机。

**air-cushion vehicle**, see hovercraft.

**气垫车**: 见 hovercraft.

**Allen key**, a metal bar with a hexagonal cross section, used to tighten nuts that have a hexagonal recess (hole) in the head. Also called hexagonal socket wrench.

**阿伦式扳手**: 一种截面为六角形的金属棒, 用于拧紧带有六角形凹槽(孔)的螺母。亦称内六角扳手。

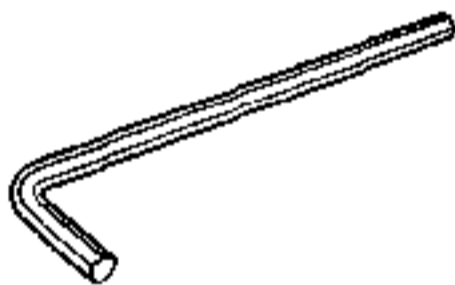

**alloy**, a mixture of two or more metals, or of a metal and nonmetal. The properties of an alloy differ from those of its components. Brass is a widely used alloy of copper and zinc; steel is an alloy of iron and carbon with other elements added for special purposes.

**合金**: 由两种或两种以上的金属, 或由一种金属与非金属组成的混合物。合金的特

性不同于其组成成份的特性。黄铜是一种广泛使用的铜锌合金; 钢是由铁和碳以及为某些专门用途而掺杂其他元素所组成的合金。

**alternating current (a.c.)**, electric current that flows alternately in one direction and then in the other. Compare direct current.

**交流 (a.c.)**: 流动方向交替变化的电流。试与直流相比较。

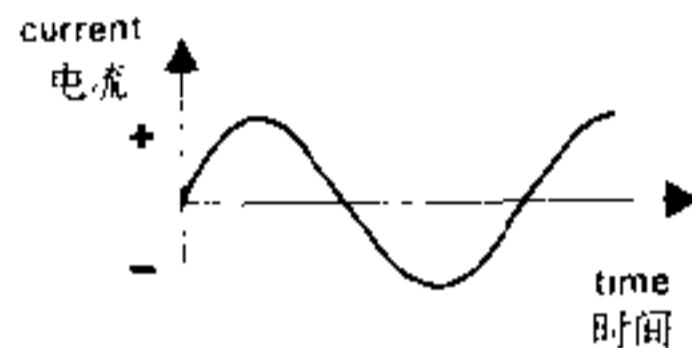

**alternator**, a type of electric \*generator used to produce alternating current. See also dynamo.

**交流发电机**: 一种用于产生交变电流的发电机。亦见发电机。

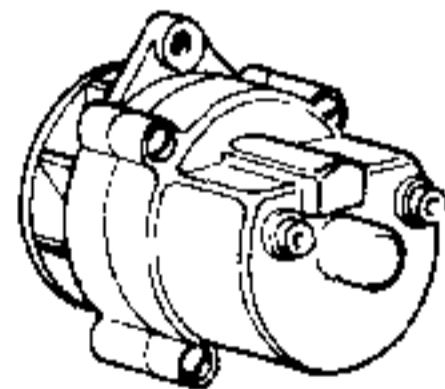

**ammeter**, an instrument that measures electric current (especially in amperes).

**安培计**: 一种测量电流的仪表(尤指以安培为单位的)。

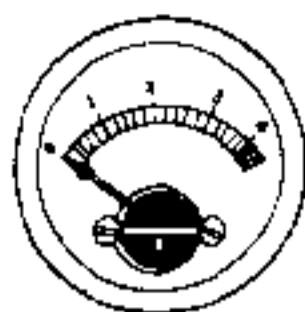

**anchor**, a device used to hold a ship in one place. The anchor buries itself in the bottom of the sea, river, or lake. It is held to the ship by a chain or rope.

**锚**：一种借以将船保持在一个地点的器具。可用锚来插入海底、河底或湖底，并通过链条或绳索与船身相连。

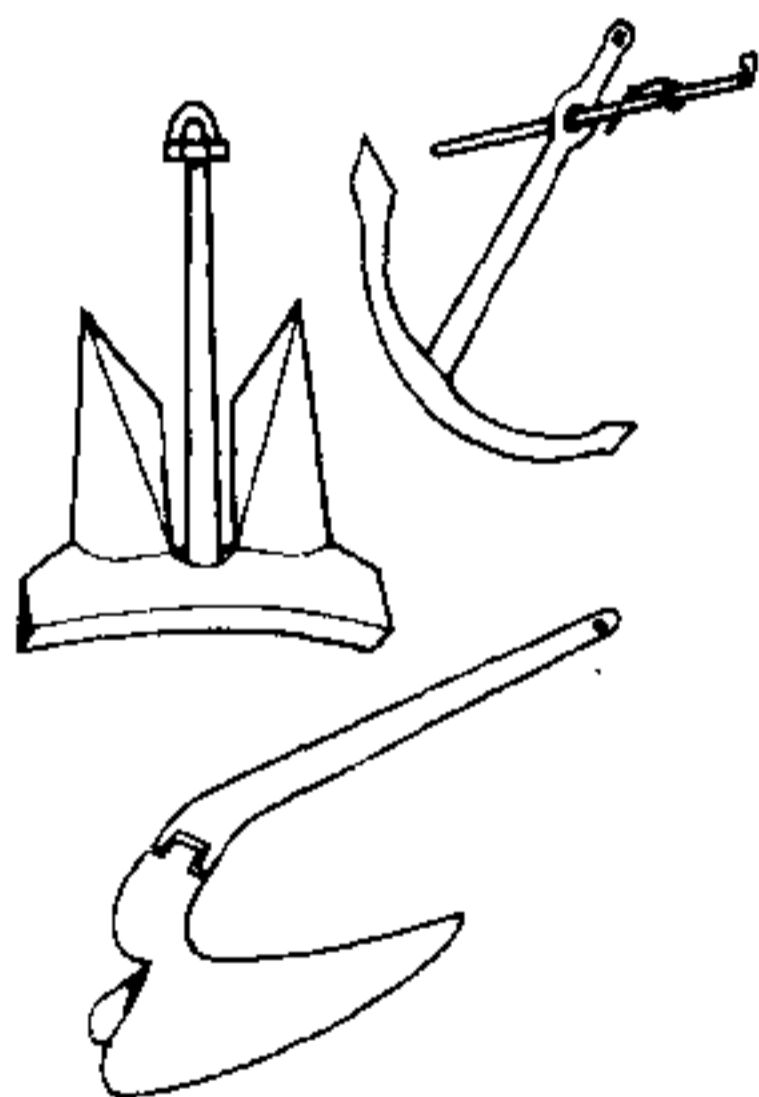

bellows move when the pressure of the atmosphere changes. This causes the pointer to move. See barometer.

**无液气压计**：一种测量大气压力的仪表。这种气压计有一对抽去了空气的金属膜盒。一根指针通过杠杆与膜盒相连。当气压变化时，膜盒发生运动，因而引起指针运动。见气压计。

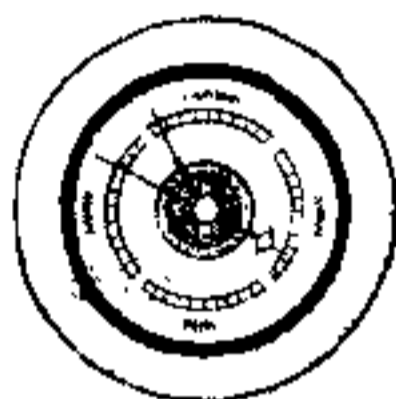

**angle**, the space between two lines (or planes) that meet at a point. Different kinds of angles have different names.

**角**：相交于一点的两条直线（或两个平面）之间的空间。不同种类的角各有不同的名称。

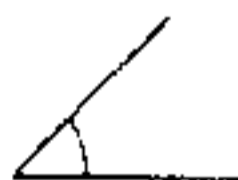

acute angle  
(less than  $90^\circ$ )

锐角 (小于  $90^\circ$ )



right angle  
( $90^\circ$ )

直角 ( $90^\circ$ )



obtuse angle  
(more than  $90^\circ$ )

钝角 (大于  $90^\circ$ )

**aneroid barometer**, an instrument used to measure the pressure of the atmosphere. It has a pair of metal bellows from which the air has been removed. A pointer is joined to the bellows by levers. The

**angle iron**, a steel bar with an L-shaped cross section. Also called steel angle section.

**角铁**: 一种截面为L形的型钢。亦称角钢。

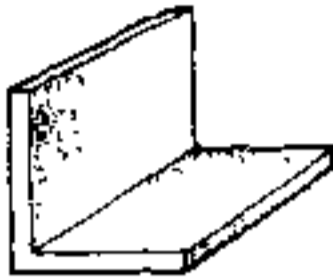

**angle plate**, a metal plate to which parts are fixed for machining or marking out. It is usually made of cast iron and accurately machined. Parts can be held by bolts through the slots.

**角板**: 一种为进行机械加工或划线而用来固定零件的金属板。通常是用铸铁经过精密加工而制成。零件可用通过长孔的螺栓来固定。

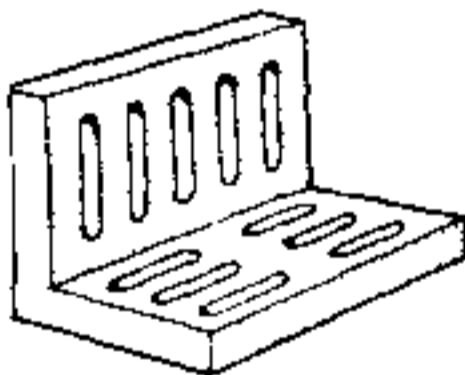

**annealing**, the process of heating and then cooling a material (e.g. a metal) to remove strains in the material.

**退火**: 将材料(如金属)加热继之加以冷却的过程,其目的是要消除材料的内应力。

**anode**, an \*electrode with a positive electric charge.

**阳极**: 带有正电荷的电极。

**anodizing**, the process of covering a metal with a hard layer of metal oxide by making it the \*anode in an electrolytic \*cell. Usually, the cell contains sulphuric acid or chromic acid. Anodizing is often used to coat aluminium with oxide.

**阳极氧化**: 通过使金属成为电解槽中阳极的方法而在金属表面覆盖一层硬质金属氧化物的过程。通常,电解槽中盛有硫酸或铬酸。阳极氧化的方法经常用于在铝上镀以氧化物。

**antenna**, see aerial.

**天线**: 见aerial.

**anvil**, a shaped block with a hardened steel face on which a piece of metal is held during forging.

**铁砧**: 一种特殊形状的台座,其表面为高火钢,锻打时,将一块金属安置于其上。

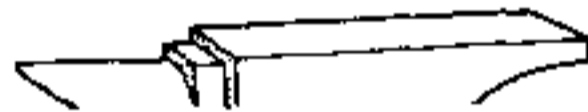

**arbor**, a rotating bar that carries a cutting tool in \*lathes or \*milling machines. It is used to hold a \*reamer or a milling tool. The cutting tool is placed on the arbor (shaded in the picture). The arbor is then put in the machine and turned quickly.

**刀轴**: 车床或铣床上借以带动刀具的旋转轴。用于固定铰刀或铣刀。先将刀具安装在刀轴(图中阴影部分)上。然后再把刀轴安装在机床上,使之快速旋转。

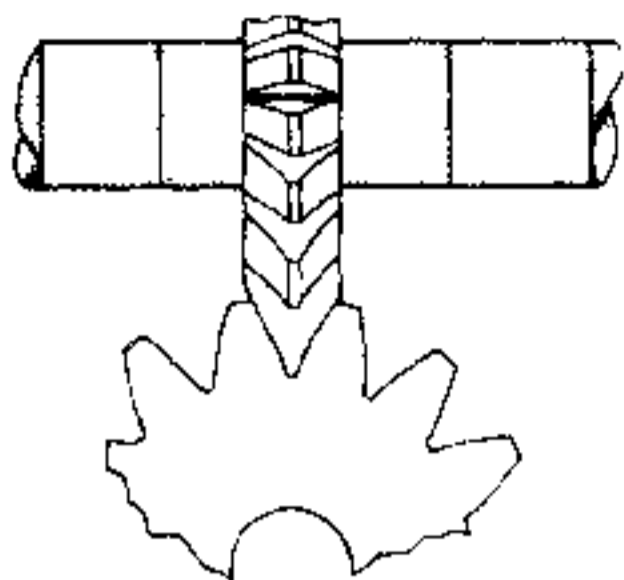

**arc**, 1. part of the circumference of a \*circle (or other curve).  
2. see electric arc.

弧<sup>1</sup>; 电弧<sup>2</sup>;

1. 圆周 (或其他曲线) 的一段。

2. 见electric arc.

**Archimedean screw**, a type of pump for lifting water, consisting of a large inclined screw in a hollow tube.

**阿基米德螺旋**, 一种抽水泵, 由安装在管筒内的一个大型倾斜螺旋所构成。

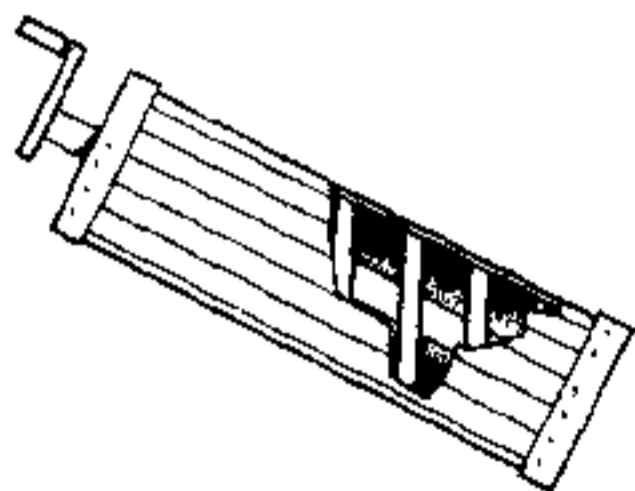

**arc welding**, a method of welding metal parts together using the heat produced by an \*electric arc.

**电弧焊**: 一种利用电弧产生的热量把金属的零件焊接在一起的方法。

**area**, the space occupied by a surface. The area of a shape is usually worked out by a single formula.

**面积**: 一个表面所占据的区域。一种形状的面积通常可用单一的公式来算出。



$$\text{area} = hs/2$$

面积 = 圆周率 × 半径<sup>2</sup>



$$\text{area} = \pi r^2$$

面积 =  $\frac{1}{2}$  (底 × 高)

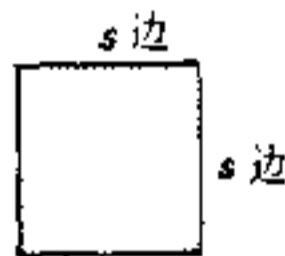

$$\text{area} = s^2$$

面积 = 边<sup>2</sup>

**armature**, 1. the rotating coil or coils in an electric motor or generator.

电枢:

1. 电动机或发电机内的一个或若干个旋转线圈。



rotating coil  
旋转线圈

2. any part of an electrical machine in which a voltage is produced by a magnetic field.

2. 电机中由磁场产生电压的任何一种部件。

**articulated lorry or truck**, a lorry that has two parts (a *tractor* and a *trailer*) connected by a pivoted bar. This allows the two parts to be at an angle to each other when cornering.

**铰接式运货汽车**: 一种分为两部分(牵引车和拖车)并用铰接杆连接在一起的载重汽车。这就使得这两部分在转弯时可以互成一个角度。



trailer  
拖车

tractor  
牵引车

**atmospheric pressure**, the pressure of the air on the surface of the earth. The average value is 101 325 pascals (14.7lbs per sq. in.) at sea level. This is equal to a pressure of 760 millimetres of mercury.

**大气压**: 地球表面上空气的压力。海平面上的平均值为101325帕斯卡(每平方英寸14.71磅)。这等于760毫米水银柱的压力。

**auger**, a tool used to bore holes in wood or in the ground. An *auger bit* is a type of drill bit used with a *brace*.

**螺旋钻**: 一种用来在木头上或地上钻孔的工具。螺旋钻头是一种与手摇曲柄钻一起使用的钻头。

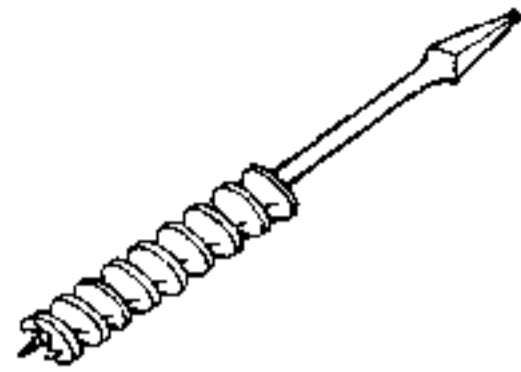

**awl**, a short pointed tool used to make small holes in leather, wood, etc. Also called *bradawl*.

**锥钻**: 用来在皮革、木头等东西上钻孔的一种尖头短工具。亦称打眼钻。

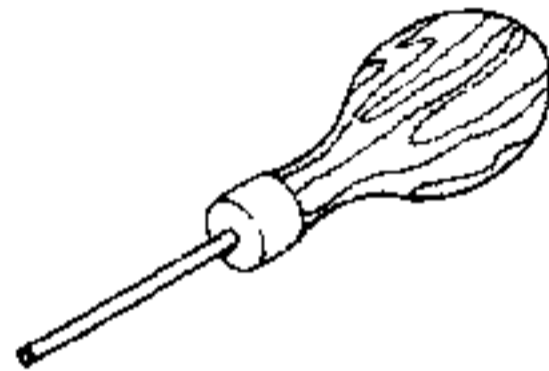

**axe**, a tool with a wooden handle and metal blade, used to cut down trees, chop wood, etc. *U.S. spelling ax.*

**斧**: 装有金属斧头和木柄的一种工具, 用以伐树或劈开木头等。美国拼法为ax。

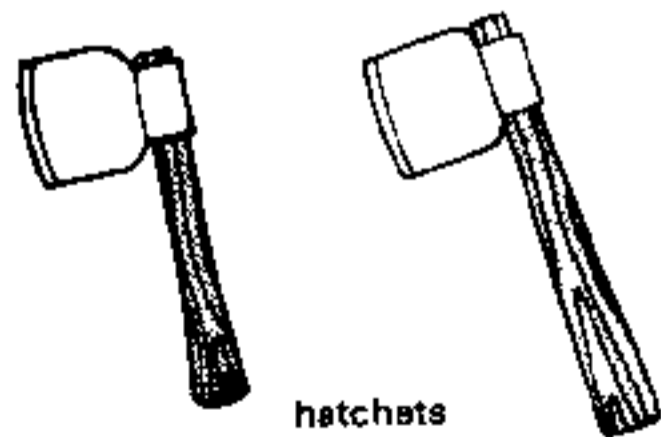

hatchets  
手斧

**axle**, a bar (usually metal) on which a wheel turns. The axle may drive the wheel or the wheel may turn freely on the axle. See also suspension system.

**轮轴**. 轮子在其上旋转的一根棒(通常为金属制成)。轮子可以由轴来驱动,或者可以在轴上自由转动。亦见**悬架系统**。

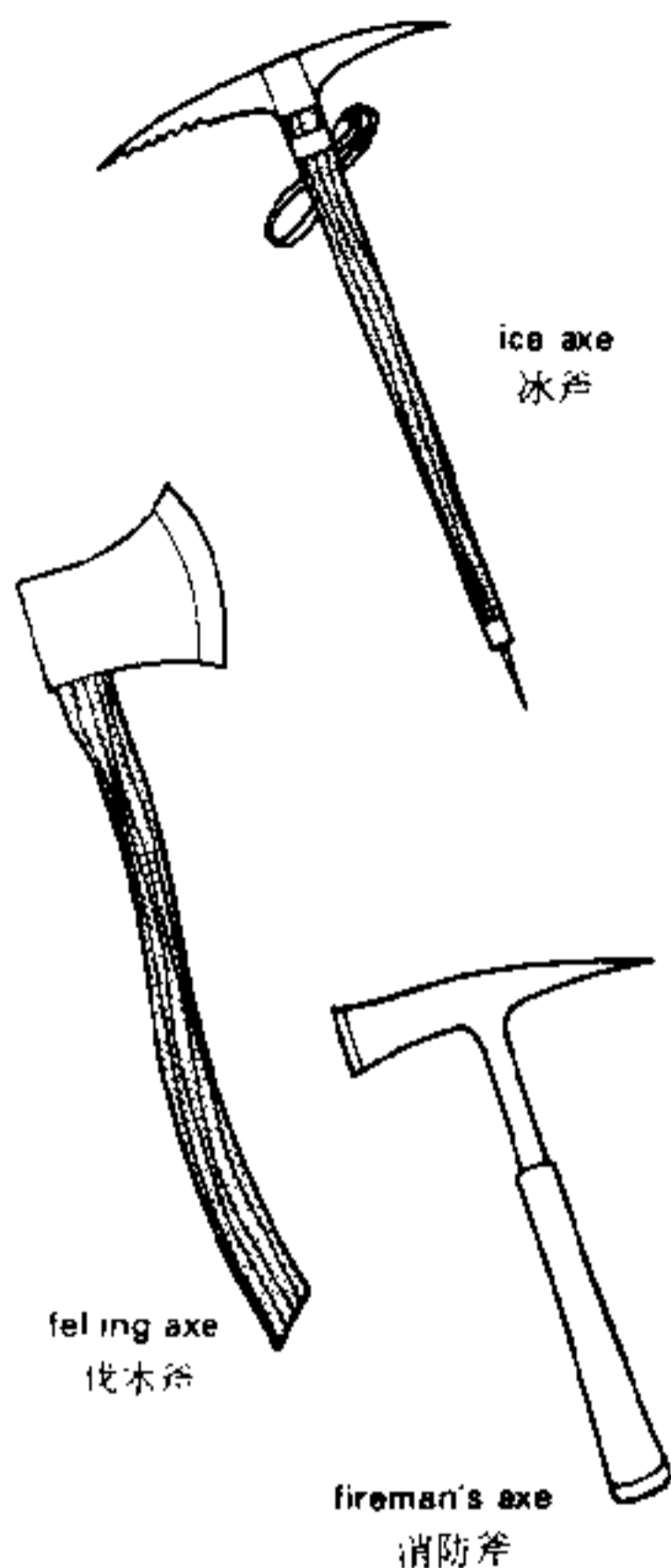

**axis**, 1. a line about which something turns.  
2. a line dividing a shape into two equal shapes. See also x-axis, y-axis.

**轴线**:

1. 物体旋转时所环绕的一条线。
2. 把一形状分成两个相等部分的一条线。

亦见**X轴**和**Y轴**。

# B

**back saw**, a type of \*saw used to cut wood. A back saw has a piece of metal on the back of the blade to stiffen it.

镶边手锯 一种用来切锯木头的锯子。这种锯在锯条脊背上装有一条金属条，用以加强锯条。

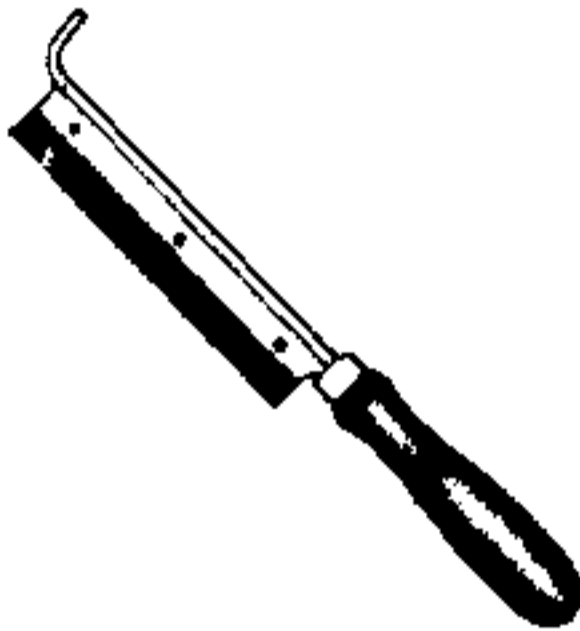

**balance wheel**, a wheel in a watch or small clock that swings back and forth against a \*hairspring to regulate the \*escapement.

摆轮：表或小钟上借助游丝弹力的来回摆动以调节擒纵机构的轮子。

**balance**, an instrument used to weigh objects. A *beam balance* has two pans, one on each end of an arm. The arm is held on a pivot at the centre. The object is placed in one pan and standard weights are added to the other pan. See also spring balance.

天平：用于称重物体的仪器。杠杆式天平有两个盘，横臂两端各有一个。横臂以其中心支架在一个支点上。一个盘里放置着物体，砝码则加在另一个盘上。亦见弹簧秤。

balance wheel    escape wheel  
摆轮            擒纵轮

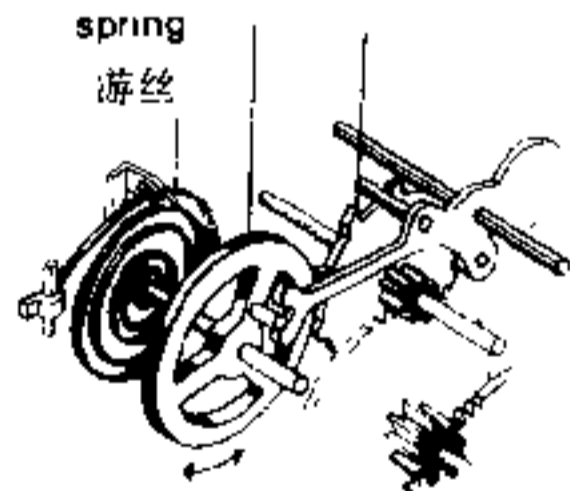

**ball and socket**, a form of flexible joint between two rods. One rod has a ball at its end; the other has a hollow cup into which the ball fits.

## ball bearing

**球窝：**两根棒之间的一种永久性连接形式。一根棒的一端为球体，另一根棒则有与球体相配合的凹窝。



**ball bearing, 1.** a form of \*bearing in which steel balls roll between a rotating shaft and a metal tube. The rolling balls reduce friction.

**滚珠轴承<sup>1</sup>；轴承滚珠<sup>2</sup>：**

1. 以钢珠在旋转轴和金属圈之间滚动的一种轴承。滚动的钢珠用以减少摩擦。

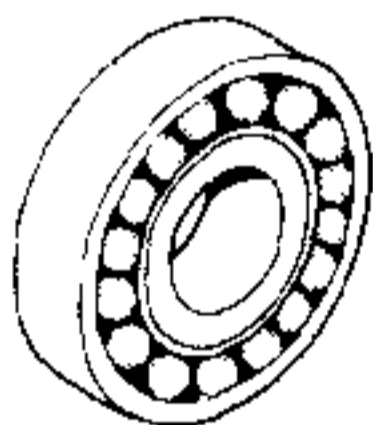

2. one of the steel balls used in this type of bearing.

2. 在这种轴承中使用的滚珠。

**ball-peen hammer, see hammer.**

**圆顶锤：**见锤。

**bandsaw, a mechanical \*saw in which the blade is an endless steel loop running over two wheels.**

**带锯：**一种机械锯，它的锯条是在两个轮子上运行的一条环状钢带。

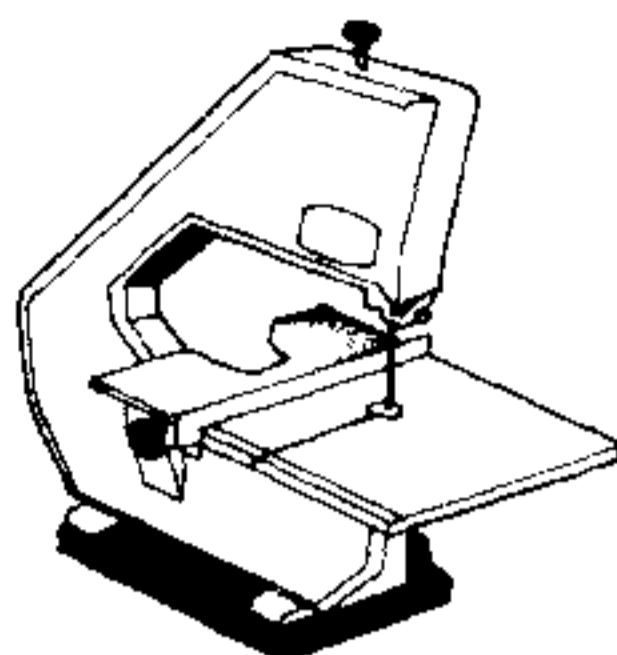

**bar magnet, a \*magnet made of a straight metal bar.**

**磁棒，条形磁铁：**用在金属棒制成的磁铁。



**barometer, an instrument used to measure \*atmospheric pressure. There are two types: the \*mercury barometer and the \*aneroid barometer.**

**气压计：**用于测量大气压的仪器。有两种类型：水银气压计和无液气压计。

**battery, a number of electric \*cells connected together to give a source of electric current. See also accumulator.**

**电池组：**将若干个电池连接在一起用以提供一个电流源的装置。亦见蓄电池。

**beam compass**, a type of compass used for drawing large circles or arcs. *Also called beam trammel, trammel.*

长臂圆规, 长径规: 一种用来画大圆或大弧的圆规。亦称beam trammel, trammel。

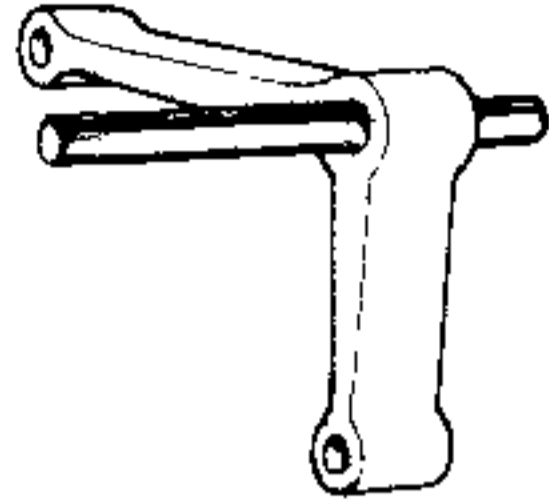
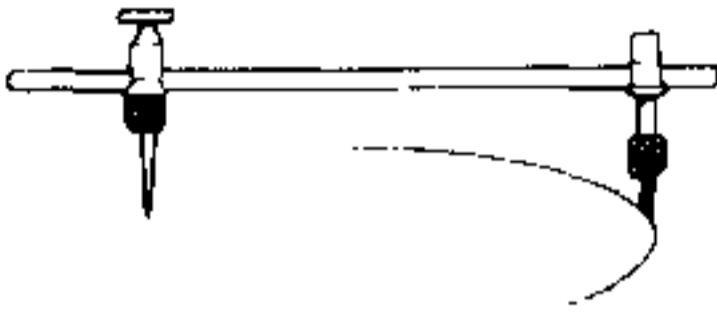

**belting**, material used to make belts; e.g. strips of rubber, fabric, leather, etc.

带料: 用以制造皮带的材料; 例如橡皮条、织物条、皮革条等等。

**beam trammel**, see beam compass.

长臂圆规, 长径规: 见beam compass.

**bearing**, a support or guide for a rotating shaft or the surface between a reciprocating part and a crank. In a *plain bearing* the two metal surfaces bear directly on one another. *See also* ball bearing, roller bearing, thrust bearing, bush.

轴承: 对旋转轴或往复运动的零件与曲轴之间的表面加以支承和导向的一种装置。

在滑动轴承中是两个金属表面的相互直接支承, 亦见滚珠轴承、滚柱轴承、推力轴承和轴衬。

**bell crank**, a lever that has two arms at an angle (usually at right angles), with the pivot at the point at which the arms meet.

曲拐: 两臂呈一角度(通常为直角)的一种杠杆。支点在两臂的交点上。

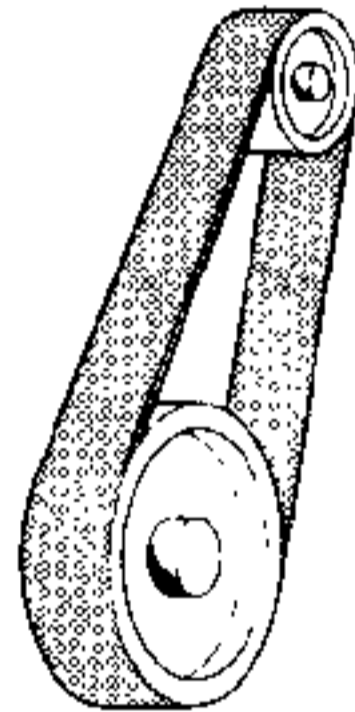

**bench**, 1. a strong wooden or metal work table often with a vice attached to it.  
2. the flat surface of a machine tool, such as a circular saw, on which the workpiece is laid.

钳工台<sup>1</sup>; 工作台<sup>2</sup>;

1. 坚实的木制或金属制台桌, 上面往往附有一台虎钳。

2. 类如圆锯等机床上的平面, 用以将工件安放在上面。